

Agilent InfiniiVision 3000 X-Series Oscilloscopes

User's Guide



Agilent Technologies

Notices

© Agilent Technologies, Inc. 2005-2012

No part of this manual may be reproduced in any form or by any means (including electronic storage and retrieval or translation into a foreign language) without prior agreement and written consent from Agilent Technologies, Inc. as governed by United States and international copyright laws.

Manual Part Number

75019-97062

Edition

Seventh edition, July 2012

Printed in Malaysia

Agilent Technologies, Inc.
1900 Garden of the Gods Road
Colorado Springs, CO 80907 USA

Print History

75019-97000, January 2011

75019-97013, February 2011

75019-97014, June 2011

75019-97027, October 2011

75019-97040, February 2012

75019-97051, March 2012

75019-97062, July 2012

Trademarks

Java is a U.S. trademark of Sun Microsystems, Inc.

Sun, Sun Microsystems, and the Sun Logo are trademarks or registered trademarks of Sun Microsystems, Inc. in the U.S. and other countries.

Warranty

The material contained in this document is provided “as is,” and is subject to being changed, without notice, in future editions. Further, to the maximum extent permitted by applicable law, Agilent disclaims all warranties, either express or implied, with regard to this manual and any information contained herein, including but not limited to the implied warranties of merchantability and fitness for a particular purpose. Agilent shall not be liable for errors or for incidental or consequential damages in connection with the furnishing, use, or performance of this document or of any information contained herein. Should Agilent and the user have a separate written agreement with warranty terms covering the material in this document that conflict with these terms, the warranty terms in the separate agreement shall control.

Technology Licenses

The hardware and/or software described in this document are furnished under a license and may be used or copied only in accordance with the terms of such license.

Restricted Rights Legend

If software is for use in the performance of a U.S. Government prime contract or subcontract, Software is delivered and licensed as “Commercial computer software” as defined in DFAR 252.227-7014 (June 1995), or as a “commercial item” as defined in FAR 2.101(a) or as “Restricted computer software” as defined in FAR 52.227-19 (June 1987) or any equivalent agency regulation or contract clause. Use, duplication or disclosure of Software is subject to Agilent Technologies’ standard commercial license terms, and non-DOD Departments and Agencies of the U.S. Government will receive no greater than Restricted Rights as

defined in FAR 52.227-19(c)(1-2) (June 1987). U.S. Government users will receive no greater than Limited Rights as defined in FAR 52.227-14 (June 1987) or DFAR 252.227-7015 (b)(2) (November 1995), as applicable in any technical data.

Safety Notices

CAUTION

A **CAUTION** notice denotes a hazard. It calls attention to an operating procedure, practice, or the like that, if not correctly performed or adhered to, could result in damage to the product or loss of important data. Do not proceed beyond a **CAUTION** notice until the indicated conditions are fully understood and met.

WARNING

A **WARNING** notice denotes a hazard. It calls attention to an operating procedure, practice, or the like that, if not correctly performed or adhered to, could result in personal injury or death. Do not proceed beyond a **WARNING** notice until the indicated conditions are fully understood and met.

InfiniiVision 3000 X-Series Oscilloscopes—At a Glance

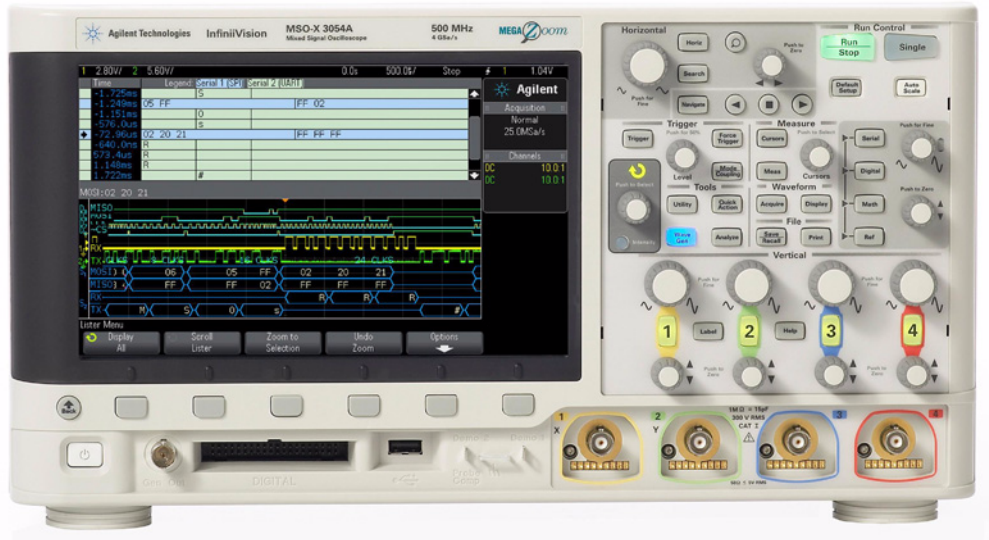

Table 1 3000 X-Series Model Numbers, Bandwidths, Sample Rates

Bandwidth	100 MHz	200 MHz	350 MHz	500 MHz	1 GHz
Sample Rate (interleaved, non-interleaved)	4 GSa/s, 2 GSa/s	4 GSa/s, 2 GSa/s	4 GSa/s, 2 GSa/s	4 GSa/s, 2 GSa/s	5 GSa/s, 2.5 GSa/s
2-Channel + 16 Logic Channels MSO	MSO-X 3012A		MSO-X 3032A	MSO-X 3052A	MSO-X 3102A
4-Channel + 16 Logic Channels MSO	MSO-X 3014A	MSO-X 3024A	MSO-X 3034A	MSO-X 3054A	MSO-X 3104A
2-Channel DSO	DSO-X 3012A		DSO-X 3032A	DSO-X 3052A	DSO-X 3102A
4-Channel DSO	DSO-X 3014A	DSO-X 3024A	DSO-X 3034A	DSO-X 3054A	DSO-X 3104A

The Agilent InfiniiVision 3000 X-Series oscilloscopes deliver these features:

- 100 MHz, 200 MHz, 350 MHz, 500 MHz, and 1 GHz bandwidth models.

- 2- and 4-channel digital storage oscilloscope (DSO) models.
- 2+16-channel and 4+16-channel mixed-signal oscilloscope (MSO) models.

An MSO lets you debug your mixed-signal designs using analog signals and tightly correlated digital signals simultaneously. The 16 digital channels have a 1 GSa/s sample rate (1.25 GSa/s for the 1 GHz models), with a 50 MHz toggle rate.

- 8.5 inch WVGA display.
- Interleaved 2 Mpts or non-interleaved 1 Mpts MegaZoom IV memory for the fastest waveform update rates, uncompromised. Upgradeable to 4 Mpts/2 Mpts.
- All knobs are pushable for making quick selections.
- Trigger types: edge, edge then edge, pulse width, pattern, OR, rise/fall time, Nth edge burst, runt, setup & hold, video, and USB.
- Serial decode/trigger options for: CAN/LIN, FlexRay, I²C/SPI, I²S, UART/RS232, and MIL-STD-1553/ARINC 429. Lister for serial decode
- Math waveforms: add, subtract, multiply, FFT, d/dt, integrate, and square root. With the DSOX3ADVMATH option, you get these additional math waveforms: Ax+B, square, absolute value, common logarithm, natural logarithm, exponential, base 10 exponential, low pass filter, high pass filter, magnify, measurement trend, chart logic bus timing, and chart logic bus state.
- Reference waveform locations (2) for comparing with other channel or math waveforms.
- Many built-in measurements and a measurement statistics display.
- Built-in license-enabled waveform generator with: arbitrary, sine, square, ramp, pulse, DC, noise, sine cardinal, exponential rise, exponential fall, cardiac, and gaussian pulse.
- USB ports make printing, saving and sharing data easy.
- Optional LAN/VGA module for connecting to a network and displaying the screen on a different monitor.
- Optional GPIB module.
- A Quick Help system is built into the oscilloscope. Press and hold any key to display Quick Help. Complete instructions for using the quick help system are given in "[Access the Built-In Quick Help](#)" on page 47.

For more information about InfiniiVision oscilloscopes, see:
["www.agilent.com/find/scope"](http://www.agilent.com/find/scope)

In This Guide

This guide shows how to use the InfiniiVision 3000 X-Series oscilloscopes.

When unpacking and using the oscilloscope for the first time, see:	<ul style="list-style-type: none">• Chapter 1, “Getting Started,” starting on page 25
When displaying waveforms and acquired data, see:	<ul style="list-style-type: none">• Chapter 2, “Horizontal Controls,” starting on page 49• Chapter 3, “Vertical Controls,” starting on page 63• Chapter 4, “Math Waveforms,” starting on page 73• Chapter 5, “Reference Waveforms,” starting on page 101• Chapter 6, “Digital Channels,” starting on page 105• Chapter 7, “Serial Decode,” starting on page 125• Chapter 8, “Display Settings,” starting on page 131• Chapter 9, “Labels,” starting on page 137
When setting up triggers or changing how data is acquired, see:	<ul style="list-style-type: none">• Chapter 10, “Triggers,” starting on page 143• Chapter 11, “Trigger Mode/Coupling,” starting on page 179• Chapter 12, “Acquisition Control,” starting on page 187
Making measurements and analyzing data:	<ul style="list-style-type: none">• Chapter 13, “Cursors,” starting on page 205• Chapter 14, “Measurements,” starting on page 215• Chapter 15, “Mask Testing,” starting on page 241• Chapter 16, “Digital Voltmeter,” starting on page 253
When using the built-in license enabled waveform generator, see:	<ul style="list-style-type: none">• Chapter 17, “Waveform Generator,” starting on page 257
When saving, recalling, or printing, see:	<ul style="list-style-type: none">• Chapter 18, “Save/Recall (Setups, Screens, Data),” starting on page 273• Chapter 19, “Print (Screens),” starting on page 289
When using the oscilloscope's utility functions or web interface, see:	<ul style="list-style-type: none">• Chapter 20, “Utility Settings,” starting on page 295• Chapter 21, “Web Interface,” starting on page 315

For reference information, see:	<ul style="list-style-type: none"> • Chapter 22, “Reference,” starting on page 331
When using licensed serial bus triggering and decode features, see:	<ul style="list-style-type: none"> • Chapter 23, “CAN/LIN Triggering and Serial Decode,” starting on page 351 • Chapter 24, “FlexRay Triggering and Serial Decode,” starting on page 367 • Chapter 25, “I2C/SPI Triggering and Serial Decode,” starting on page 377 • Chapter 26, “I2S Triggering and Serial Decode,” starting on page 397 • Chapter 27, “MIL-STD-1553/ARINC 429 Triggering and Serial Decode,” starting on page 407 • Chapter 28, “UART/RS232 Triggering and Serial Decode,” starting on page 423

TIP

Abbreviated instructions for pressing a series of keys and softkeys

Instructions for pressing a series of keys are written in an abbreviated manner. Instructions for pressing **[Key1]**, then pressing **Softkey2**, then pressing **Softkey3** are abbreviated as follows:

Press **[Key1]> Softkey2 > Softkey3**.

The keys may be a front panel **[Key]** or a **Softkey**. Softkeys are the six keys located directly below the oscilloscope display.

Contents

InfiniiVision 3000 X-Series Oscilloscopes—At a Glance 3

In This Guide 6

1 Getting Started

Inspect the Package Contents 25

Install the Optional LAN/VGA or GPIB Module 28

Tilt the Oscilloscope for Easy Viewing 28

Power-On the Oscilloscope 29

Connect Probes to the Oscilloscope 30



Maximum input voltage at analog inputs 30



Do not float the oscilloscope chassis 31

Input a Waveform 31

Recall the Default Oscilloscope Setup 31

Use Auto Scale 32

Compensate Passive Probes 34

Learn the Front Panel Controls and Connectors 35

Front Panel Overlays for Different Languages 42

Learn the Rear Panel Connectors 44

Learn the Oscilloscope Display 45

Access the Built-In Quick Help 47

2 Horizontal Controls

- To adjust the horizontal (time/div) scale 50
- To adjust the horizontal delay (position) 51
- Panning and Zooming Single or Stopped Acquisitions 52
- To change the horizontal time mode (Normal, XY, or Roll) 53
 - XY Time Mode 54
- To display the zoomed time base 56
- To change the horizontal scale knob's coarse/fine adjustment setting 58
- To position the time reference (left, center, right) 58
- Searching for Events 59
 - To set up searches 59
 - To copy search setups 60
- Navigating the Time Base 60
 - To navigate time 61
 - To navigate search events 61
 - To navigate segments 62

3 Vertical Controls

- To turn waveforms on or off (channel or math) 64
- To adjust the vertical scale 65
- To adjust the vertical position 65
- To specify channel coupling 65
- To specify channel input impedance 66
- To specify bandwidth limiting 67
- To change the vertical scale knob's coarse/fine adjustment setting 67
- To invert a waveform 68

Setting Analog Channel Probe Options	68
To specify the channel units	69
To specify the probe attenuation	69
To specify the probe skew	70
To calibrate a probe	70

4 Math Waveforms

To display math waveforms	73
To perform transforms or filters on an arithmetic operation	75
To adjust the math waveform scale and offset	75
Units for Math Waveforms	76
Math Operators	76
Add or Subtract	77
Multiply or Divide	77
Math Transforms	78
Differentiate	79
Integrate	80
FFT Measurement	83
Square Root	90
Ax + B	90
Square	91
Absolute Value	92
Common Logarithm	92
Natural Logarithm	93
Exponential	93
Base 10 Exponential	94
Math Filters	94
High Pass and Low Pass Filter	95
Math Visualizations	96
Magnify	96

Measurement Trend	97
Chart Logic Bus Timing	98
Chart Logic Bus State	99

5 Reference Waveforms

To save a waveform to a reference waveform location	101
To display a reference waveform	102
To scale and position reference waveforms	103
To adjust reference waveform skew	103
To display reference waveform information	104
To save/recall reference waveform files to/from a USB storage device	104

6 Digital Channels

To connect the digital probes to the device under test	105
 Probe cable for digital channels	106
Acquiring waveforms using the digital channels	109
To display digital channels using AutoScale	109
Interpreting the digital waveform display	110
To change the displayed size of the digital channels	111
To switch a single channel on or off	112
To switch all digital channels on or off	112
To switch groups of channels on or off	112
To change the logic threshold for digital channels	112
To reposition a digital channel	113
To display digital channels as a bus	114

Digital channel signal fidelity: Probe impedance and grounding	117
Input Impedance	118
Probe Grounding	120
Best Probing Practices	122
To replace digital probe leads	122

7 Serial Decode

Serial Decode Options	125
Lister	126
Searching Lister Data	128

8 Display Settings

To adjust waveform intensity	131
To set or clear persistence	133
To clear the display	134
To select the grid type	134
To adjust the grid intensity	135
To freeze the display	135

9 Labels

To turn the label display on or off	137
To assign a predefined label to a channel	138
To define a new label	139
To load a list of labels from a text file you create	140
To reset the label library to the factory default	141

10 Triggers

Adjusting the Trigger Level	145
-----------------------------	-----

Forcing a Trigger	145
Edge Trigger	146
Edge then Edge Trigger	148
Pulse Width Trigger	149
Pattern Trigger	152
Hex Bus Pattern Trigger	155
OR Trigger	155
Rise/Fall Time Trigger	157
Nth Edge Burst Trigger	158
Runt Trigger	160
Setup and Hold Trigger	162
Video Trigger	163
To set up Generic video triggers	168
To trigger on a specific line of video	168
To trigger on all sync pulses	170
To trigger on a specific field of the video signal	170
To trigger on all fields of the video signal	171
To trigger on odd or even fields	172
USB Trigger	175
Serial Trigger	177

11 Trigger Mode/Coupling

To select the Auto or Normal trigger mode	180
To select the trigger coupling	182
To enable or disable trigger noise rejection	183
To enable or disable trigger HF Reject	183
To set the trigger holdoff	184

External Trigger Input 184



Maximum voltage at oscilloscope external trigger input 185

12 Acquisition Control

Running, Stopping, and Making Single Acquisitions (Run Control) 187

Overview of Sampling 189

Sampling Theory 189

Aliasing 189

Oscilloscope Bandwidth and Sample Rate 190

Oscilloscope Rise Time 191

Oscilloscope Bandwidth Required 192

Memory Depth and Sample Rate 193

Selecting the Acquisition Mode 193

Normal Acquisition Mode 194

Peak Detect Acquisition Mode 194

Averaging Acquisition Mode 197

High Resolution Acquisition Mode 199

Acquiring to Segmented Memory 199

Navigating Segments 201

Measurements, Statistics, and Infinite Persistence with Segmented Memory 201

Segmented Memory Re-Arm Time 202

Saving Data from Segmented Memory 202

13 Cursors

To make cursor measurements 206

Cursor Examples 209

14 Measurements

To make automatic measurements	216
Measurements Summary	217
Snapshot All	219
Voltage Measurements	220
Peak-Peak	221
Maximum	221
Minimum	221
Amplitude	221
Top	221
Base	222
Overshoot	223
Preshoot	224
Average	224
DC RMS	225
AC RMS	225
Ratio	227
Time Measurements	227
Period	228
Frequency	228
Counter	229
+ Width	230
– Width	230
Burst Width	230
Duty Cycle	230
Rise Time	231
Fall Time	231
Delay	231
Phase	232
X at Min Y	233
X at Max Y	234

Count Measurements	234
Positive Pulse Count	234
Negative Pulse Count	235
Rising Edge Count	235
Falling Edges Count	235
Mixed Measurements	235
Area	235
Measurement Thresholds	236
Measurement Window with Zoom Display	238
Measurement Statistics	238

15 Mask Testing

To create a mask from a "golden" waveform (Automask)	241
Mask Test Setup Options	243
Mask Statistics	246
To manually modify a mask file	247
Building a Mask File	250
How is mask testing done?	252

16 Digital Voltmeter

17 Waveform Generator

To select generated waveform types and settings	257
To edit arbitrary waveforms	261
Creating New Arbitrary Waveforms	262
Editing Existing Arbitrary Waveforms	263
Capturing Other Waveforms to the Arbitrary Waveform	264
To output the waveform generator sync pulse	265
To specify the expected output load	265

- To use waveform generator logic presets 266
- To add noise to the waveform generator output 267
- To add modulation to the waveform generator output 267
 - To set up Amplitude Modulation (AM) 268
 - To set up Frequency Modulation (FM) 269
 - To set up Frequency-Shift Keying Modulation (FSK) 271
- To restore waveform generator defaults 272

18 Save/Recall (Setups, Screens, Data)

- Saving Setups, Screen Images, or Data 273
 - To save setup files 275
 - To save BMP or PNG image files 275
 - To save CSV, ASCII XY, or BIN data files 277
 - To save ALB data files 277
 - Length Control 279
 - To save Lister data files 281
 - To save reference waveform files to a USB storage device 281
 - To save masks 281
 - To save arbitrary waveforms 282
 - To navigate storage locations 282
 - To enter file names 283
- Recalling Setups, Masks, or Data 284
 - To recall setup files 284
 - To recall mask files 285
 - To recall reference waveform files from a USB storage device 285
 - To recall arbitrary waveforms 285
- Recalling Default Setups 286
- Performing a Secure Erase 287

19 Print (Screens)

- To print the oscilloscope's display 289
- To set up network printer connections 290
- To specify the print options 292
- To specify the palette option 293

20 Utility Settings

- I/O Interface Settings 295
- Setting up the Oscilloscope's LAN Connection 296
 - To establish a LAN connection 297
 - Stand-alone (Point-to-Point) Connection to a PC 298
- File Explorer 299
- Setting Oscilloscope Preferences 301
 - To choose "expand about" center or ground 301
 - To disable/enable transparent backgrounds 302
 - To load the default label library 302
 - To set up the screen saver 302
 - To set AutoScale preferences 303
- Setting the Oscilloscope's Clock 304
- Setting the Rear Panel TRIG OUT Source 304
- Performing Service Tasks 305
 - To perform user calibration 306
 - To perform hardware self test 308
 - To perform front panel self test 309
 - To display oscilloscope information 309
 - To display the user calibration status 309
 - To clean the oscilloscope 309
 - To check warranty and extended services status 310
 - To contact Agilent 310

To return the instrument	310
Configuring the [Quick Action] Key	311
Adding an Annotation	312

21 Web Interface

Accessing the Web Interface	316
Browser Web Control	317
Real Scope Remote Front Panel	318
Simple Remote Front Panel	319
Browser-Based Remote Front Panel	320
Remote Programming via the Web Interface	321
Remote Programming with Agilent IO Libraries	322
Save/Recall	323
Saving Files via the Web Interface	323
Recalling Files via the Web Interface	324
Get Image	325
Identification Function	326
Instrument Utilities	326
Setting a Password	327

22 Reference

Specifications and Characteristics	331
Measurement Category	331
Oscilloscope Measurement Category	332
Measurement Category Definitions	332
Transient Withstand Capability	333
	
Maximum input voltage at analog inputs	333



Maximum input voltage at digital channels 333

Environmental Conditions 333

Probes and Accessories 334

Passive Probes 335

Single-Ended Active Probes 335

Differential Probes 336

Current Probes 337

Accessories Available 338

Loading Licenses and Displaying License Information 339

Licensed Options Available 339

Other Options Available 341

Upgrading to an MSO 341

Software and Firmware Updates 341

Binary Data (.bin) Format 342

Binary Data in MATLAB 343

Binary Header Format 343

Example Program for Reading Binary Data 345

Examples of Binary Files 346

CSV and ASCII XY files 348

CSV and ASCII XY file structure 349

Minimum and Maximum Values in CSV Files 349

Acknowledgements 350

23 CAN/LIN Triggering and Serial Decode

Setup for CAN Signals 351

CAN Triggering 353

CAN Serial Decode 355

Interpreting CAN Decode 356

CAN Totalizer	357
Interpreting CAN Lister Data	358
Searching for CAN Data in the Lister	359
Setup for LIN Signals	359
LIN Triggering	361
LIN Serial Decode	363
Interpreting LIN Decode	364
Interpreting LIN Lister Data	365
Searching for LIN Data in the Lister	366

24 FlexRay Triggering and Serial Decode

Setup for FlexRay Signals	367
FlexRay Triggering	368
Triggering on FlexRay Frames	369
Triggering on FlexRay Errors	370
Triggering on FlexRay Events	370
FlexRay Serial Decode	371
Interpreting FlexRay Decode	372
FlexRay Totalizer	373
Interpreting FlexRay Lister Data	374
Searching for FlexRay Data in the Lister	374

25 I2C/SPI Triggering and Serial Decode

Setup for I2C Signals	377
I2C Triggering	378
I2C Serial Decode	382
Interpreting I2C Decode	383
Interpreting I2C Lister Data	384
Searching for I2C Data in the Lister	385
Setup for SPI Signals	386

SPI Triggering	389
SPI Serial Decode	391
Interpreting SPI Decode	393
Interpreting SPI Lister Data	394
Searching for SPI Data in the Lister	394

26 I2S Triggering and Serial Decode

Setup for I2S Signals	397
I2S Triggering	400
I2S Serial Decode	403
Interpreting I2S Decode	404
Interpreting I2S Lister Data	405
Searching for I2S Data in the Lister	405

27 MIL-STD-1553/ARINC 429 Triggering and Serial Decode

Setup for MIL-STD-1553 Signals	407
MIL-STD-1553 Triggering	409
MIL-STD-1553 Serial Decode	410
Interpreting MIL-STD-1553 Decode	411
Interpreting MIL-STD-1553 Lister Data	412
Searching for MIL-STD-1553 Data in the Lister	413
Setup for ARINC 429 Signals	414
ARINC 429 Triggering	415
ARINC 429 Serial Decode	417
Interpreting ARINC 429 Decode	419
ARINC 429 Totalizer	420
Interpreting ARINC 429 Lister Data	421
Searching for ARINC 429 Data in the Lister	421

28 UART/RS232 Triggering and Serial Decode

Setup for UART/RS232 Signals 423

UART/RS232 Triggering 425

UART/RS232 Serial Decode 427

Interpreting UART/RS232 Decode 429

UART/RS232 Totalizer 430

Interpreting UART/RS232 Lister Data 431

Searching for UART/RS232 Data in the Lister 431

Index

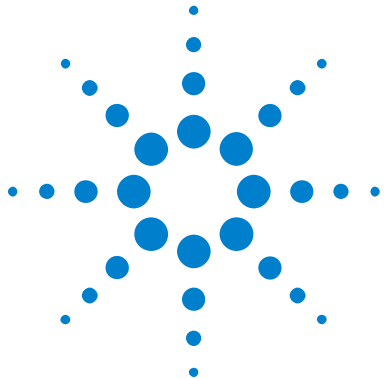

1 Getting Started

Inspect the Package Contents	25
Tilt the Oscilloscope for Easy Viewing	28
Power-On the Oscilloscope	29
Connect Probes to the Oscilloscope	30
Input a Waveform	31
Recall the Default Oscilloscope Setup	31
Use Auto Scale	32
Compensate Passive Probes	34
Learn the Front Panel Controls and Connectors	35
Learn the Rear Panel Connectors	44
Learn the Oscilloscope Display	45
Access the Built-In Quick Help	47

This chapter describes the steps you take when using the oscilloscope for the first time.

Inspect the Package Contents

- Inspect the shipping container for damage.

If your shipping container appears to be damaged, keep the shipping container or cushioning material until you have inspected the contents of the shipment for completeness and have checked the oscilloscope mechanically and electrically.

- Verify that you received the following items and any optional accessories you may have ordered:



1 Getting Started

- InfiniiVision 3000 X-Series oscilloscope.
- Power cord (country of origin determines specific type).
- Oscilloscope probes:
 - Two probes for 2-channel models.
 - Four probes for 4-channel models.
- Documentation CD-ROM.

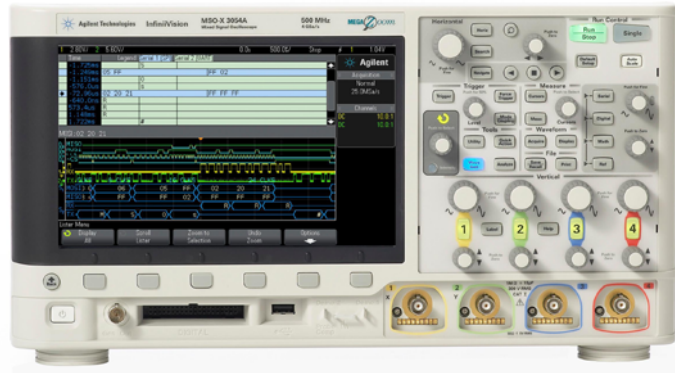

InfiniiVision 3000 X-Series oscilloscope

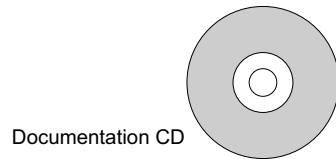

Documentation CD

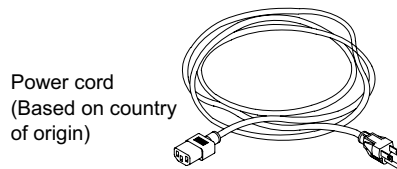
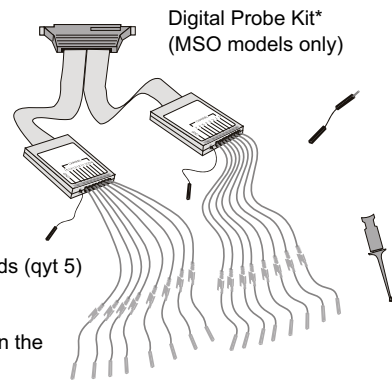
N2862B, N2863B,
or N2890A probes
(Qty 2 or 4)Power cord
(Based on country
of origin)Digital Probe Kit*
(MSO models only)

*N6450-60001 Digital Probe Kit contains:
 N6450-61601 16-channel cable (qyt 1)
 01650-82103 2-inch probe ground leads (qyt 5)
 5090-4832 Grabber (qyt 20)

Digital probe replacement parts are listed in the
 "Digital Channels" chapter.

See Also • ["Accessories Available"](#) on page 338

Install the Optional LAN/VGA or GPIB Module

If you need to install a DSOXLAN LAN/VGA module or a DSOXGPIB GPIB module, perform this installation before you power on the oscilloscope.

- 1 If you need to remove a module before installing a different module, pinch the module's spring tabs, and gently remove the module from the slot.
- 2 To install a module, slide the module into the slot on the back until it is fully seated.

The module's spring tabs will latch into the slot, keeping the module in place.

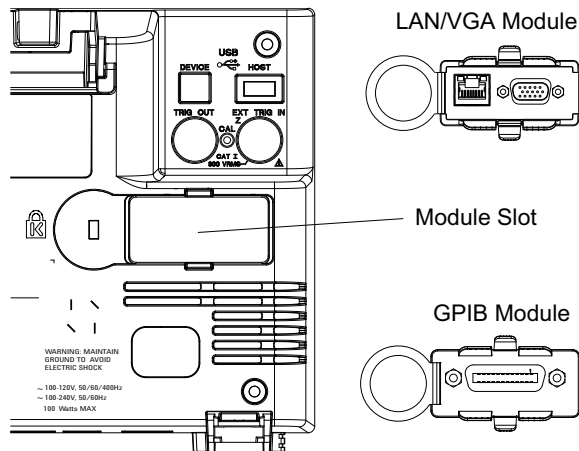

NOTE

The LAN/VGA or GPIB module must be installed before powering on the oscilloscope.

Tilt the Oscilloscope for Easy Viewing

There are tabs under the oscilloscope's front feet that can be flipped out to tilt the oscilloscope.

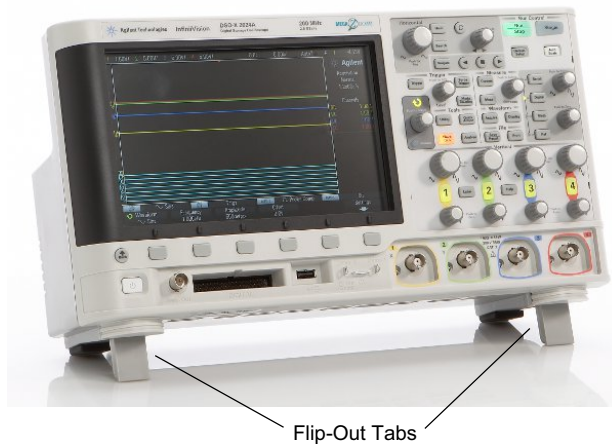

Flip-Out Tabs

Power-On the Oscilloscope

- Power Requirements** Line voltage, frequency, and power:
- ~Line 100-120 Vac, 50/60/400 Hz
 - 100-240 Vac, 50/60 Hz
 - 100 W max

Ventilation Requirements The air intake and exhaust areas must be free from obstructions. Unrestricted air flow is required for proper cooling. Always ensure that the air intake and exhaust areas are free from obstructions.

The fan draws air in from the left side and bottom of the oscilloscope and pushes it out behind the oscilloscope.

When using the oscilloscope in a bench-top setting, provide at least 2" clearance at the sides and 4" (100 mm) clearance above and behind the oscilloscope for proper cooling.

- To power-on the oscilloscope**
- 1 Connect the power cord to the rear of the oscilloscope, then to a suitable AC voltage source. Route the power cord so the oscilloscope's feet and legs do not pinch the cord.

1 Getting Started

- 2 The oscilloscope automatically adjusts for input line voltages in the range 100 to 240 VAC. The line cord provided is matched to the country of origin.

WARNING

Always use a grounded power cord. Do not defeat the power cord ground.

- 3 Press the power switch.

The power switch is located on the lower left corner of the front panel. The oscilloscope will perform a self-test and will be operational in a few seconds.

Connect Probes to the Oscilloscope

- 1 Connect the oscilloscope probe to an oscilloscope channel BNC connector.
- 2 Connect the probe's retractable hook tip to the point of interest on the circuit or device under test. Be sure to connect the probe ground lead to a ground point on the circuit.

CAUTION

Maximum input voltage at analog inputs

CAT I 300 Vrms, 400 Vpk; transient overvoltage 1.6 kVpk

50 Ω input: 5 Vrms Input protection is enabled in 50 Ω mode and the 50 Ω load will disconnect if greater than 5 Vrms is detected. However the inputs could still be damaged, depending on the time constant of the signal. The 50 Ω input protection only functions when the oscilloscope is powered on.

With 10073C 10:1 probe: CAT I 500 Vpk, CAT II 400 Vpk

With N2862A or N2863A 10:1 probe: 300 Vrms

CAUTION **Do not float the oscilloscope chassis**

Defeating the ground connection and "floating" the oscilloscope chassis will probably result in inaccurate measurements and may also cause equipment damage. The probe ground lead is connected to the oscilloscope chassis and the ground wire in the power cord. If you need to measure between two live points, use a differential probe with sufficient dynamic range.

WARNING

Do not negate the protective action of the ground connection to the oscilloscope. The oscilloscope must remain grounded through its power cord. Defeating the ground creates an electric shock hazard.

Input a Waveform

The first signal to input to the oscilloscope is the Demo 2, Probe Comp signal. This signal is used for compensating probes.

- 1 Connect an oscilloscope probe from channel 1 to the **Demo 2** (Probe Comp) terminal on the front panel.
- 2 Connect the probe's ground lead to the ground terminal (next to the **Demo 2** terminal).

Recall the Default Oscilloscope Setup

To recall the default oscilloscope setup:

- 1 Press [**Default Setup**].

The default setup restores the oscilloscope's default settings. This places the oscilloscope in a known operating condition. The major default settings are:

Table 2 Default Configuration Settings

Horizontal	Normal mode, 100 μ s/div scale, 0 s delay, center time reference.
Vertical (Analog)	Channel 1 on, 5 V/div scale, DC coupling, 0 V position, 1 M Ω impedance.
Trigger	Edge trigger, Auto trigger mode, 0 V level, channel 1 source, DC coupling, rising edge slope, 40 ns holdoff time.
Display	Persistence off, 20% grid intensity.
Other	Acquire mode normal, [Run/Stop] to Run, cursors and measurements off.
Labels	All custom labels that you have created in the Label Library are preserved (not erased), but all channel labels will be set to their original names.

In the Save/Recall Menu, there are also options for restoring the complete factory settings (see [“Recalling Default Setups”](#) on page 286) or performing a secure erase (see [“Performing a Secure Erase”](#) on page 287).

Use Auto Scale

Use **[Auto Scale]** to automatically configure the oscilloscope to best display the input signals.

1 Press **[Auto Scale]**.

You should see a waveform on the oscilloscope's display similar to this:

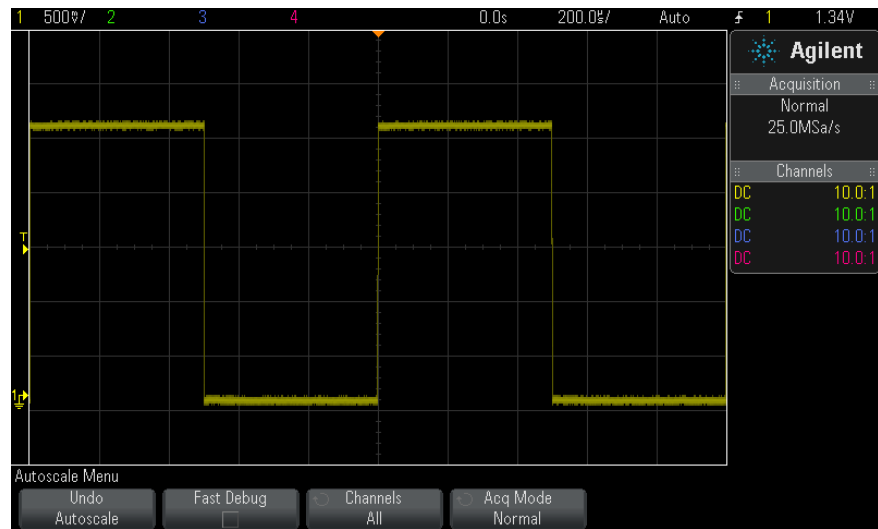

- 2 If you want to return to the oscilloscope settings that existed before, press **Undo AutoScale**.
- 3 If you want to enable "fast debug" autoscaling, change the channels autoscaled, or preserve the acquisition mode during autoscale, press **Fast Debug**, **Channels**, or **Acq Mode**.

These are the same softkeys that appear in the AutoScale Preferences Menu. See ["To set AutoScale preferences"](#) on page 303.

If you see the waveform, but the square wave is not shaped correctly as shown above, perform the procedure ["Compensate Passive Probes"](#) on page 34.

If you do not see the waveform, make sure the probe is connected securely to the front panel channel input BNC and to the left side, Demo 2, Probe Comp terminal.

How AutoScale Works

Auto Scale analyzes any waveforms present at each channel and at the external trigger input. This includes the digital channels, if connected.

Auto Scale finds, turns on, and scales any channel with a repetitive waveform that has a frequency of at least 25 Hz, a duty cycle greater than 0.5%, and an amplitude of at least 10 mV peak-to-peak. Any channels that do not meet these requirements are turned off.

The trigger source is selected by looking for the first valid waveform starting with external trigger, then continuing with the lowest number analog channel up to the highest number analog channel, and finally (if digital probes are connected) the highest number digital channel.

During Auto Scale, the delay is set to 0.0 seconds, the horizontal time/div (sweep speed) setting is a function of the input signal (about 2 periods of the triggered signal on the screen), and the triggering mode is set to Edge.

Compensate Passive Probes

Each oscilloscope passive probe must be compensated to match the input characteristics of the oscilloscope channel to which it is connected. A poorly compensated probe can introduce significant measurement errors.

- 1 Input the Probe Comp signal (see [“Input a Waveform”](#) on page 31).
- 2 Press [**Default Setup**] to recall the default oscilloscope setup (see [“Recall the Default Oscilloscope Setup”](#) on page 31).
- 3 Press [**Auto Scale**] to automatically configure the oscilloscope for the Probe Comp signal (see [“Use Auto Scale”](#) on page 32).
- 4 Press the channel key to which the probe is connected ([**1**], [**2**], etc.).
- 5 In the Channel Menu, press **Probe**.
- 6 In the Channel Probe Menu, press **Probe Check**; then, follow the instructions on-screen.

If necessary, use a nonmetallic tool (supplied with the probe) to adjust the trimmer capacitor on the probe for the flattest pulse possible.

On the N2862/63/90 probes, the trimmer capacitor is the yellow adjustment on the probe tip. On other probes, the trimmer capacitor is located on the probe BNC connector.

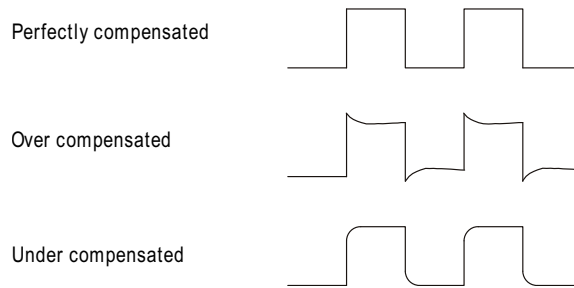

- 7 Connect probes to all other oscilloscope channels (channel 2 of a 2-channel oscilloscope, or channels 2, 3, and 4 of a 4-channel oscilloscope).
- 8 Repeat the procedure for each channel.

Learn the Front Panel Controls and Connectors



On the front panel, *key* refers to any key (button) you can press.



Softkey specifically refers to the six keys that are directly below the display. The legend for these keys is directly above them, on the display. Their functions change as you navigate through the oscilloscope's menus.

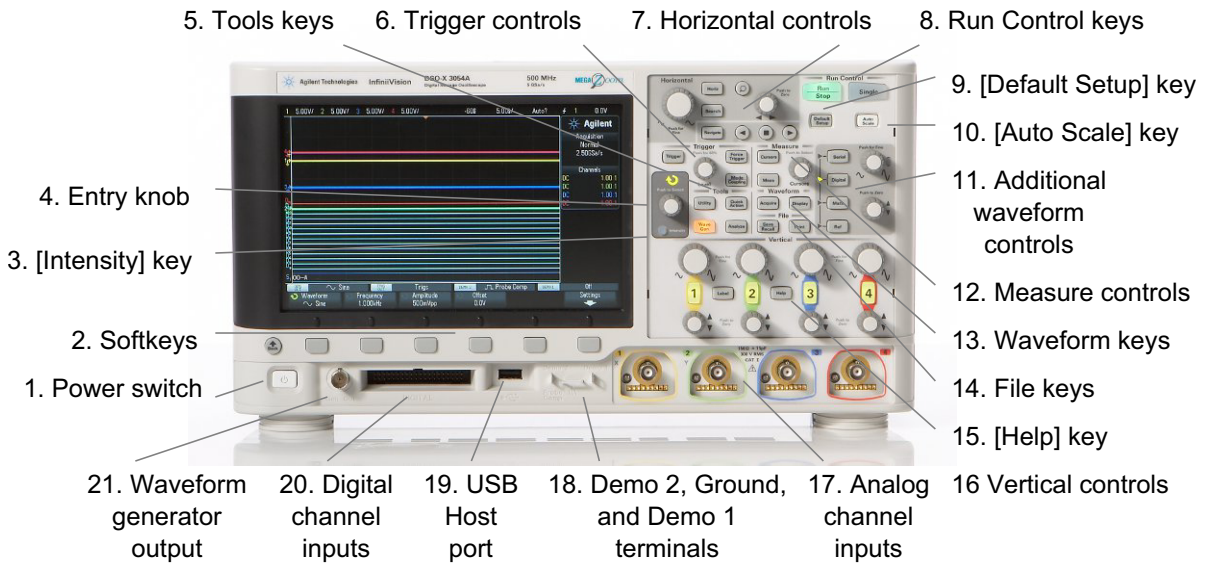

For the following figure, refer to the numbered descriptions in the table that follows.

1 Getting Started



1.	Power switch	Press once to switch power on; press again to switch power off. See "Power-On the Oscilloscope" on page 29.
2.	Softkeys	The functions of these keys change based upon the menus shown on the display directly above the keys. The  Back/Up key moves up in the softkey menu hierarchy. At the top of the hierarchy, the  Back/Up key turns the menus off, and oscilloscope information is shown instead.
3.	[Intensity] key	Press the key to illuminate it. When illuminated, turn the Entry knob to adjust waveform intensity. You can vary the intensity control to bring out signal detail, much like an analog oscilloscope. Digital channel waveform intensity is not adjustable. More details about using the Intensity control to view signal detail are on "To adjust waveform intensity" on page 131.

4.	Entry knob	<p>The Entry knob is used to select items from menus and to change values. The function of the Entry knob changes based upon the current menu and softkey selections.</p> <p>Note that the curved arrow symbol  above the entry knob illuminates whenever the entry knob can be used to select a value. Also, note that when the Entry knob  symbol appears on a softkey, you can use the Entry knob, to select values.</p> <p>Often, rotating the Entry knob is enough to make a selection. Sometimes, you can push the Entry knob to enable or disable a selection. Pushing the Entry knob also makes popup menus disappear.</p>
5.	Tools keys	<p>The Tools keys consist of:</p> <ul style="list-style-type: none"> • [Utility] key — Press this key to access the Utility Menu, which lets you configure the oscilloscope's I/O settings, use the file explorer, set preferences, access the service menu, and choose other options. See Chapter 20, "Utility Settings," starting on page 295. • [Quick Action] key — Press this key to perform the selected quick action: measure all snapshot, print, save, recall, freeze display, and more. See "Configuring the [Quick Action] Key" on page 311. • [Analyze] key — Press this key to access analysis features like trigger level setting, measurement threshold setting, Video trigger automatic set up and display, mask testing (see Chapter 15, "Mask Testing," starting on page 241), or the DSOX3PWR power measurement and analysis application. • [Wave Gen] key — Press this key to access waveform generator functions. See Chapter 17, "Waveform Generator," starting on page 257.
6.	Trigger controls	<p>These controls determine how the oscilloscope triggers to capture data. See Chapter 10, "Triggers," starting on page 143 and Chapter 11, "Trigger Mode/Coupling," starting on page 179.</p>

7.	Horizontal controls	<p>The Horizontal controls consist of:</p> <ul style="list-style-type: none"> • Horizontal scale knob — Turn the knob in the Horizontal section that is marked  to adjust the time/div (sweep speed) setting. The symbols under the knob indicate that this control has the effect of spreading out or zooming in on the waveform using the horizontal scale. • Horizontal position knob — Turn the knob marked ◀▶ to pan through the waveform data horizontally. You can see the captured waveform before the trigger (turn the knob clockwise) or after the trigger (turn the knob counterclockwise). If you pan through the waveform when the oscilloscope is stopped (not in Run mode) then you are looking at the waveform data from the last acquisition taken. • [Horiz] key — Press this key to open the Horizontal Menu where you can select XY and Roll modes, enable or disable Zoom, enable or disable horizontal time/division fine adjustment, and select the trigger time reference point. • Zoom  key — Press the  zoom key to split the oscilloscope display into Normal and Zoom sections without opening the Horizontal Menu. • [Search] key — Lets you search for events in the acquired data. • [Navigate] keys — Press this key to navigate through captured data (Time), search events, or segmented memory acquisitions. See “Navigating the Time Base” on page 60. <p>For more information see Chapter 2, “Horizontal Controls,” starting on page 49.</p>
8.	Run Control keys	<p>When the [Run/Stop] key is green, the oscilloscope is running, that is, acquiring data when trigger conditions are met. To stop acquiring data, press [Run/Stop].</p> <p>When the [Run/Stop] key is red, data acquisition is stopped. To start acquiring data, press [Run/Stop].</p> <p>To capture and display a single acquisition (whether the oscilloscope is running or stopped), press [Single]. The [Single] key is yellow until the oscilloscope triggers.</p> <p>For more information, see “Running, Stopping, and Making Single Acquisitions (Run Control)” on page 187.</p>
9.	[Default Setup] key	<p>Press this key to restore the oscilloscope's default settings (details on “Recall the Default Oscilloscope Setup” on page 31).</p>

10.	[Auto Scale] key	When you press the [AutoScale] key, the oscilloscope will quickly determine which channels have activity, and it will turn these channels on and scale them to display the input signals. See "Use Auto Scale" on page 32.
11.	Additional waveform controls	<p>The additional waveform controls consist of:</p> <ul style="list-style-type: none"> • [Math] key — provides access to math (add, subtract, etc.) waveform functions. See Chapter 4, "Math Waveforms," starting on page 73. • [Ref] key — provides access to reference waveform functions. Reference waveforms are saved waveforms that can be displayed and compared against other analog channel or math waveforms. See Chapter 5, "Reference Waveforms," starting on page 101. • [Digital] key — Press this key to turn the digital channels on or off (the arrow to the left will illuminate). When the arrow to the left of the [Digital] key is illuminated, the upper multiplexed knob selects (and highlights in red) individual digital channels, and the lower multiplexed knob positions the selected digital channel. If a trace is repositioned over an existing trace the indicator at the left edge of the trace will change from Dnn designation (where nn is a one or two digit channel number from 0 to 15) to D*. The "*" indicates that two channels are overlaid. You can rotate the upper knob to select an overlaid channel, then rotate the lower knob to position it just as you would any other channel. For more information on digital channels see Chapter 6, "Digital Channels," starting on page 105. • [Serial] key — This key is used to enable serial decode. The multiplexed scale and position knobs are not used with serial decode. For more information on serial decode, see Chapter 7, "Serial Decode," starting on page 125. • Multiplexed scale knob — This scale knob is used with Math, Ref, or Digital waveforms, whichever has the illuminated arrow to the left. For math and reference waveforms, the scale knob acts like an analog channel vertical scale knob. • Multiplexed position knob — This position knob is used with Math, Ref, or Digital waveforms, whichever has the illuminated arrow to the left. For math and reference waveforms, the position knob acts like an analog channel vertical position knob.

1 Getting Started

12.	Measure controls	<p>The measure controls consist of:</p> <ul style="list-style-type: none">• Cursors knob — Push this knob select cursors from a popup menu. Then, after the popup menu closes (either by timeout or by pushing the knob again), rotate the knob to adjust the selected cursor position.• [Cursors] key — Press this key to open a menu that lets you select the cursors mode and source.• [Meas] key — Press this key to access a set of predefined measurements. See Chapter 14, "Measurements," starting on page 215.
13.	Waveform keys	<p>The [Acquire] key lets you select Normal, Peak Detect, Averaging, or High Resolution acquisition modes (see "Selecting the Acquisition Mode" on page 193) and use segmented memory (see "Acquiring to Segmented Memory" on page 199).</p> <p>The [Display] key lets you access the menu where you can enable persistence (see "To set or clear persistence" on page 133), clear the display, and adjust the display grid (graticule) intensity (see "To adjust the grid intensity" on page 135).</p>
14.	File keys	<p>Press the [Save/Recall] key to save or recall a waveform or setup. See Chapter 18, "Save/Recall (Setups, Screens, Data)," starting on page 273.</p> <p>The [Print] key opens the Print Configuration Menu so you can print the displayed waveforms. See Chapter 19, "Print (Screens)," starting on page 289.</p>
15.	[Help] key	<p>Opens the Help Menu where you can display overview help topics and select the Language. See also "Access the Built-In Quick Help" on page 47.</p>

16.	Vertical controls	<p>The Vertical controls consist of:</p> <ul style="list-style-type: none"> • Analog channel on/off keys — Use these keys to switch a channel on or off, or to access a channel's menu in the softkeys. There is one channel on/off key for each analog channel. • Vertical scale knob — There are knobs marked  for each channel. Use these knobs to change the vertical sensitivity (gain) of each analog channel. • Vertical position knobs — Use these knobs to change a channel's vertical position on the display. There is one Vertical Position control for each analog channel. • [Label] key — Press this key to access the Label Menu, which lets you enter labels to identify each trace on the oscilloscope display. See Chapter 9, "Labels," starting on page 137. <p>For more information, see Chapter 3, "Vertical Controls," starting on page 63.</p>
17.	Analog channel inputs	<p>Attach oscilloscope probes or BNC cables to these BNC connectors. With the InfiniiVision 3000 X-Series oscilloscopes, you can set the input impedance of the analog channels to either 50 Ω or 1 MΩ. See "To specify channel input impedance" on page 66.</p> <p>The InfiniiVision 3000 X-Series oscilloscopes also provide the AutoProbe interface. The AutoProbe interface uses a series of contacts directly below the channel's BNC connector to transfer information between the oscilloscope and the probe. When you connect a compatible probe to the oscilloscope, the AutoProbe interface determines the type of probe and sets the oscilloscope's parameters (units, offset, attenuation, coupling, and impedance) accordingly.</p>
18.	Demo 2, Ground, and Demo 1 terminals	<ul style="list-style-type: none"> • Demo 2 terminal — This terminal outputs the Probe Comp signal which helps you match a probe's input capacitance to the oscilloscope channel to which it is connected. See "Compensate Passive Probes" on page 34. With certain licensed features, the oscilloscope can also output demo or training signals on this terminal. • Ground terminal — Use the ground terminal for oscilloscope probes connected to the Demo 1 or Demo 2 terminals. • Demo 1 terminal — With certain licensed features, the oscilloscope can output demo or training signals on this terminal.

19.	USB Host port	<p>This port is for connecting USB mass storage devices or printers to the oscilloscope.</p> <p>Connect a USB compliant mass storage device (flash drive, disk drive, etc.) to save or recall oscilloscope setup files and reference waveforms or to save data and screen images. See Chapter 18, "Save/Recall (Setups, Screens, Data)," starting on page 273.</p> <p>To print, connect a USB compliant printer. For more information about printing see Chapter 19, "Print (Screens)," starting on page 289.</p> <p>You can also use the USB port to update the oscilloscope's system software when updates are available.</p> <p>You do not need to take special precautions before removing the USB mass storage device from the oscilloscope (you do not need to "eject" it). Simply unplug the USB mass storage device from the oscilloscope when the file operation is complete.</p> <p>CAUTION:  Do not connect a host computer to the oscilloscope's USB host port. Use the device port. A host computer sees the oscilloscope as a device, so connect the host computer to the oscilloscope's device port (on the rear panel). See "I/O Interface Settings" on page 295.</p> <p>There is a second USB host port on the back panel.</p>
20.	Digital channel inputs	<p>Connect the digital probe cable to this connector (MSO models only). See Chapter 6, "Digital Channels," starting on page 105.</p>
21.	Waveform generator output	<p>Outputs sine, square, ramp, pulse, DC, or noise on the Gen Out BNC. Press the [Wave Gen] key to set up the waveform generator. See Chapter 17, "Waveform Generator," starting on page 257.</p>

Front Panel Overlays for Different Languages

Front panel overlays, which have translations for the English front panel keys and label text, are available in 10 languages. The appropriate overlay is included when the localization option is chosen at time of purchase.

To install a front panel overlay:

- 1 Gently pull on the front panel knobs to remove them.
- 2 Insert the overlay's side tabs into the slots on the front panel.

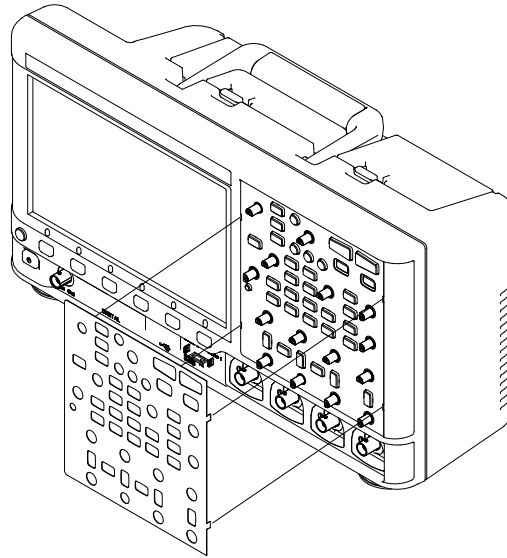

3 Reinstall the front panel knobs.

Front panel overlays may be ordered from "www.parts.agilent.com" using the following part numbers:

Language	2 Channel Overlay	4 Channel Overlay
French	75019-94324	75019-94316
German	75019-94326	75019-94318
Italian	75019-94323	75019-94331
Japanese	75019-94311	75019-94312
Korean	75019-94329	75019-94321
Portuguese	75019-94327	75019-94319
Russian	75019-94322	75019-94315
Simplified Chinese	75019-94328	75019-94320
Spanish	75019-94325	75019-94317
Traditional Chinese	75019-94330	75019-94310

Learn the Rear Panel Connectors

For the following figure, refer to the numbered descriptions in the table that follows.

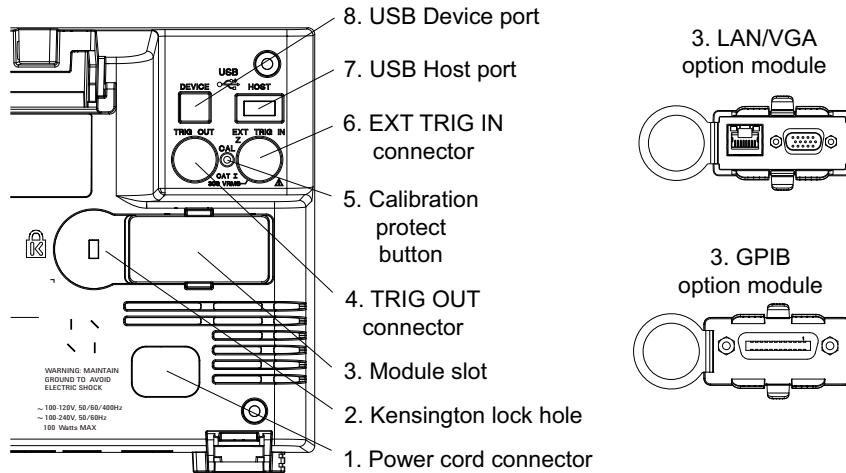

1.	Power cord connector	Attach the power cord here.
2.	Kensington lock hole	This is where you can attach a Kensington lock for securing the instrument.
3.	Module slot	<p>A DSOXLAN LAN/VGA module may be ordered and installed separately.</p> <ul style="list-style-type: none"> • LAN port — lets you communicate with the oscilloscope and use the Remote Front Panel feature using the LAN port. See Chapter 21, “Web Interface,” starting on page 315 and “Accessing the Web Interface” on page 316. • VGA video output — lets you connect an external monitor or projector to provide a larger display or to provide a display at a viewing position away from the oscilloscope. The oscilloscope's built-in display remains on even when an external display is connected. The video output connector is always active. For optimal video quality and performance, we recommend you use a shielded video cable with ferrite cores. <p>A DSOXGPIB GPIB module may be ordered and installed separately.</p>

4.	TRIG OUT connector	Trigger output BNC connector. See "Setting the Rear Panel TRIG OUT Source" on page 304.
5.	Calibration protect button	See "To perform user calibration" on page 306.
6.	EXT TRIG IN connector	External trigger input BNC connector. See "External Trigger Input" on page 184 for an explanation of this feature.
7.	USB Host port	This port functions identically to the USB host port on the front panel. USB Host Port is used for saving data from the oscilloscope and loading software updates. See also USB Host port (see page 42).
8.	USB Device port	This port is for connecting the oscilloscope to a host PC. You can issue remote commands from a host PC to the oscilloscope via the USB device port. See "Remote Programming with Agilent IO Libraries" on page 322.

Learn the Oscilloscope Display

The oscilloscope display contains acquired waveforms, setup information, measurement results, and the softkey definitions.

1 Getting Started

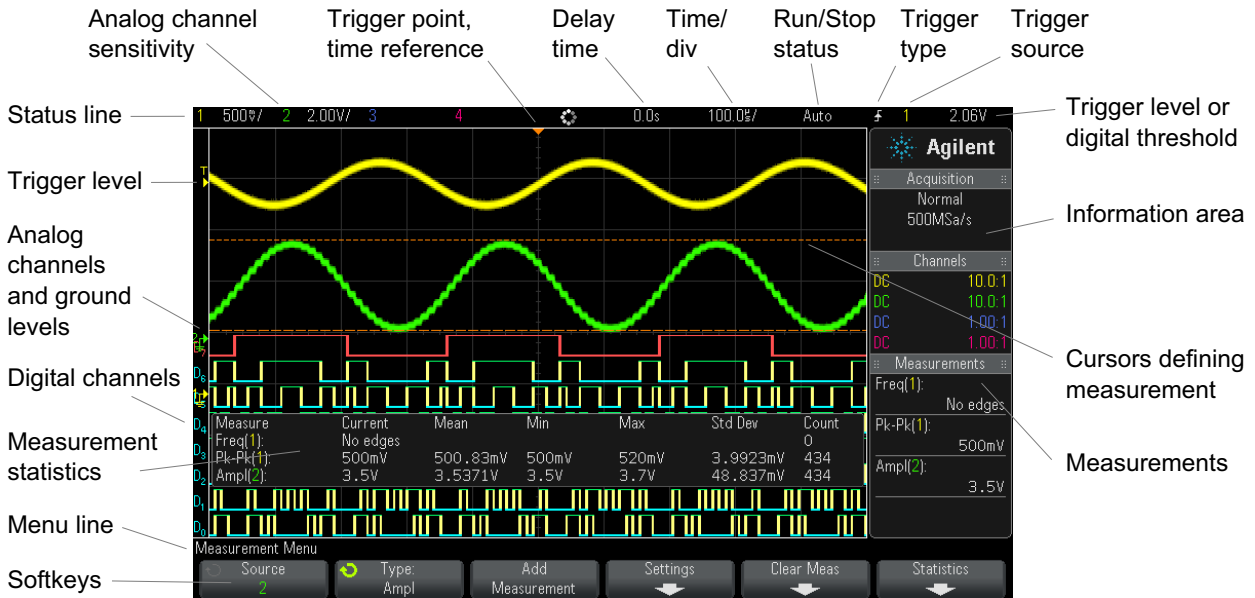



Figure 1 Interpreting the oscilloscope display

Status line	The top line of the display contains vertical, horizontal, and trigger setup information.
Display area	The display area contains the waveform acquisitions, channel identifiers, and analog trigger, and ground level indicators. Each analog channel's information appears in a different color. Signal detail is displayed using 256 levels of intensity. For more information about viewing signal detail see "To adjust waveform intensity" on page 131. For more information about display modes see Chapter 8, "Display Settings," starting on page 131.
Information area	The information area normally contains acquisition, analog channel, automatic measurement, and cursor results.
Menu line	This line normally contains menu name or other information associated with the selected menu.

Softkey labels	<p>These labels describe softkey functions. Typically, softkeys let you set up additional parameters for the selected mode or menu.</p> <p>Pressing the  Back/Up key at the top of the menu hierarchy turns off softkey labels and displays additional status information describing channel offset and other configuration parameters.</p>
----------------	--

Access the Built-In Quick Help

- To view Quick Help**
- 1 Press and hold the key or softkey for which you would like to view help.

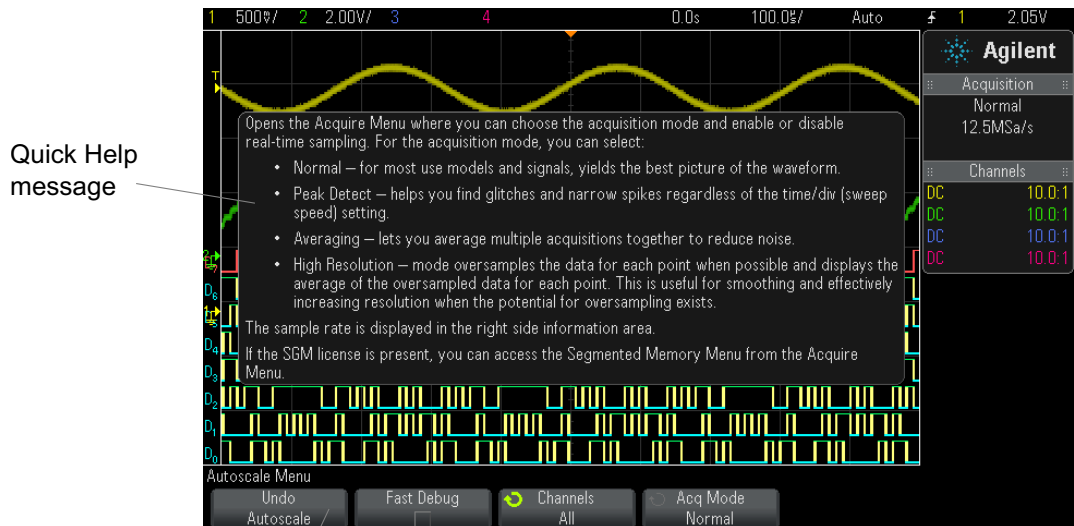

Press and hold front panel key or softkey
(or right-click softkey when using web browser remote front panel).

Quick Help remains on the screen until another key is pressed or a knob is turned.

1 Getting Started

To select the user interface and Quick Help language

To select the user interface and Quick Help language:

- 1 Press **[Help]**, then press the **Language** softkey.
- 2 Repeatedly press and release the **Language** softkey or rotate the Entry knob until the desired language is selected.

The following languages are available: English, French, German, Italian, Japanese, Korean, Portuguese, Russian, Simplified Chinese, Spanish, and Traditional Chinese.



2 Horizontal Controls

- To adjust the horizontal (time/div) scale 50
- To adjust the horizontal delay (position) 51
- Panning and Zooming Single or Stopped Acquisitions 52
- To change the horizontal time mode (Normal, XY, or Roll) 53
- To display the zoomed time base 56
- To change the horizontal scale knob's coarse/fine adjustment setting 58
- To position the time reference (left, center, right) 58
- Searching for Events 59
- Navigating the Time Base 60

The horizontal controls include:

- The horizontal scale and position knobs.
- The **[Horiz]** key for accessing the Horizontal Menu.
- The  zoom key for quickly enabling/disabling the split-screen zoom display.
- The **[Search]** key for finding events on analog channels or in serial decode.
- The **[Navigate]** keys for navigating time, search events, or segmented memory acquisitions.

The following figure shows the Horizontal Menu which appears after pressing the **[Horiz]** key.



2 Horizontal Controls

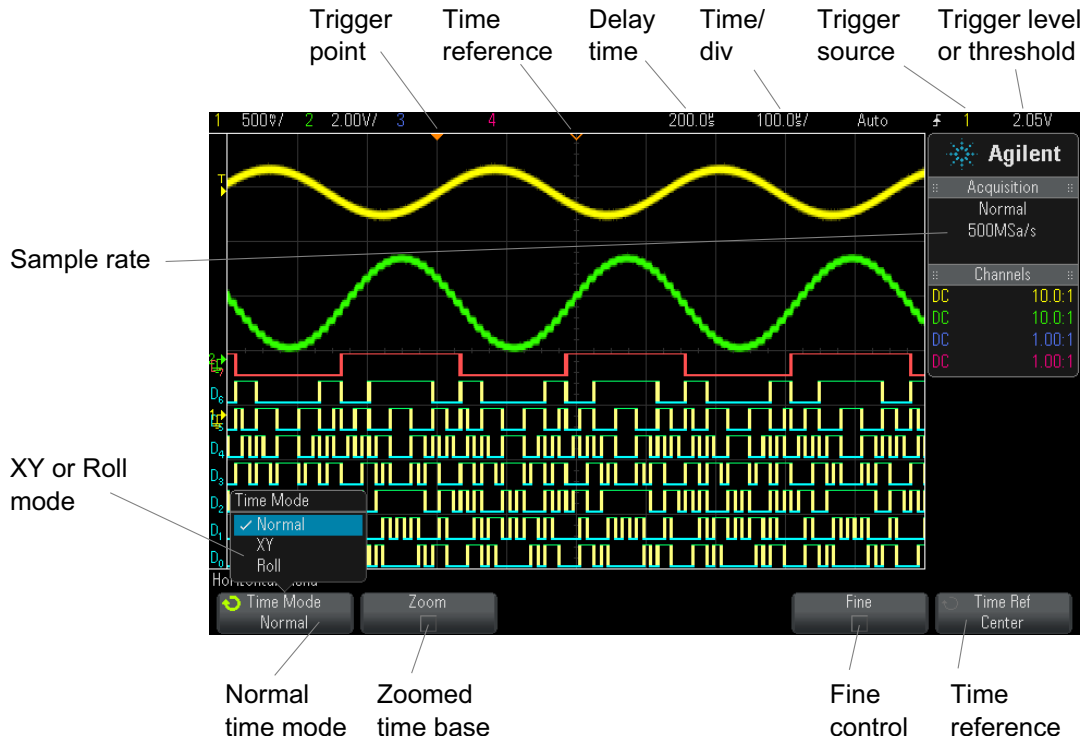



Figure 2 Horizontal Menu

The Horizontal Menu lets you select the time mode (Normal, XY, or Roll), enable Zoom, set the time base fine control (vernier), and specify the time reference.

The current sample rate is displayed in the right-side information area.

To adjust the horizontal (time/div) scale

- 1 Turn the large horizontal scale (sweep speed) knob marked  to change the horizontal time/div setting.

Notice how the time/div information in the status line changes.

The ∇ symbol at the top of the display indicates the time reference point.

The horizontal scale knob works (in the Normal time mode) while acquisitions are running or when they are stopped. When running, adjusting the horizontal scale knob changes the sample rate. When stopped, adjusting the horizontal scale knob lets you zoom into acquired data. See ["Panning and Zooming Single or Stopped Acquisitions"](#) on page 52.

Note that the horizontal scale knob has a different purpose in the Zoom display. See ["To display the zoomed time base"](#) on page 56.

To adjust the horizontal delay (position)

- 1 Turn the horizontal delay (position) knob ($\blacktriangleleft\blacktriangleright$).

The trigger point moves horizontally, pausing at 0.00 s (mimicking a mechanical detent), and the delay value is displayed in the status line.

Changing the delay time moves the trigger point (solid inverted triangle) horizontally and indicates how far it is from the time reference point (hollow inverted triangle ∇). These reference points are indicated along the top of the display grid.

[Figure 2](#) shows the trigger point with the delay time set to 200 μ s. The delay time number tells you how far the time reference point is located from the trigger point. When delay time is set to zero, the delay time indicator overlays the time reference indicator.

All events displayed left of the trigger point happened before the trigger occurred. These events are called pre-trigger information, and they show events that led up to the trigger point.

Everything to the right of the trigger point is called post-trigger information. The amount of delay range (pre-trigger and post-trigger information) available depends on the time/div selected and memory depth.

The horizontal position knob works (in the Normal time mode) while acquisitions are running or when they are stopped. When running, adjusting the horizontal scale knob changes the sample rate. When

stopped, adjusting the horizontal scale knob lets you zoom into acquired data. See ["Panning and Zooming Single or Stopped Acquisitions"](#) on page 52.

Note that the horizontal position knob has a different purpose in the Zoom display. See ["To display the zoomed time base"](#) on page 56.

Panning and Zooming Single or Stopped Acquisitions

When the oscilloscope is stopped, use the horizontal scale and position knobs to pan and zoom your waveform. The stopped display may contain several acquisitions worth of information, but only the last acquisition is available for pan and zoom.

The ability to pan (move horizontally) and scale (expand or compress horizontally) an acquired waveform is important because of the additional insight it can reveal about the captured waveform. This additional insight is often gained from seeing the waveform at different levels of abstraction. You may want to view both the big picture and the specific little picture details.

The ability to examine waveform detail after the waveform has been acquired is a benefit generally associated with digital oscilloscopes. Often this is simply the ability to freeze the display for the purpose of measuring with cursors or printing the screen. Some digital oscilloscopes go one step further by including the ability to further examine the signal details after acquiring them by panning through the waveform and changing the horizontal scale.

There is no limit imposed on the scaling ratio between the time/div used to acquire the data and the time/div used to view the data. There is, however, a useful limit. This useful limit is somewhat a function of the signal you are analyzing.

NOTE

Zooming into stopped acquisitions

The screen will still contain a relatively good display if you zoom-in horizontally by a factor of 1000 and zoom-in vertically by a factor of 10 to display the information from where it was acquired. Remember that you can only make automatic measurements on displayed data.

To change the horizontal time mode (Normal, XY, or Roll)

- 1 Press [**Horiz**].
- 2 In the Horizontal Menu, press **Time Mode**; then, select:
 - **Normal** – the normal viewing mode for the oscilloscope.

In the Normal time mode, signal events occurring before the trigger are plotted to the left of the trigger point (▼) and signal events after the trigger plotted to the right of the trigger point.

- **XY** – XY mode changes the display from a volts-versus-time display to a volts-versus-volts display. The time base is turned off. Channel 1 amplitude is plotted on the X-axis and Channel 2 amplitude is plotted on the Y-axis.

You can use XY mode to compare frequency and phase relationships between two signals. XY mode can also be used with transducers to display strain versus displacement, flow versus pressure, volts versus current, or voltage versus frequency.

Use the cursors to make measurements on XY mode waveforms.

For more information about using XY mode for measurements, refer to "XY Time Mode" on page 54.

- **Roll** – causes the waveform to move slowly across the screen from right to left. It only operates on time base settings of 50 ms/div and slower. If the current time base setting is faster than the 50 ms/div limit, it will be set to 50 ms/div when Roll mode is entered.

In Roll mode there is no trigger. The fixed reference point on the screen is the right edge of the screen and refers to the current moment in time. Events that have occurred are scrolled to the left of the reference point. Since there is no trigger, no pre-trigger information is available.

If you would like to pause the display in Roll mode press the [**Single**] key. To clear the display and restart an acquisition in Roll mode, press the [**Single**] key again.

Use Roll mode on low-frequency waveforms to yield a display much like a strip chart recorder. It allows the waveform to roll across the display.

XY Time Mode

The XY time mode converts the oscilloscope from a volts-versus-time display to a volts-versus-volts display using two input channels. Channel 1 is the X-axis input, channel 2 is the Y-axis input. You can use various transducers so the display could show strain versus displacement, flow versus pressure, volts versus current, or voltage versus frequency.

Example This exercise shows a common use of the XY display mode by measuring the phase difference between two signals of the same frequency with the Lissajous method.

- 1 Connect a sine wave signal to channel 1, and a sine wave signal of the same frequency but out of phase to channel 2.
- 2 Press the **[AutoScale]** key, press the **[Horiz]** key; then, press **Time Mode** and select "XY".
- 3 Center the signal on the display with the channel 1 and 2 position (↕) knobs. Use the channel 1 and 2 volts/div knobs and the channel 1 and 2 **Fine** softkeys to expand the signal for convenient viewing.

The phase difference angle (θ) can be calculated using the following formula (assuming the amplitude is the same on both channels):

$$\sin\theta = \frac{A}{B} \text{ or } \frac{C}{D}$$

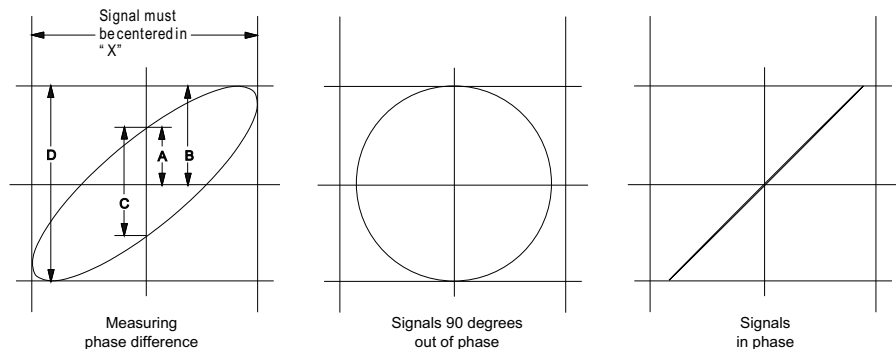

Figure 3 XY time mode signals, centered on display

- 4 Press the **[Cursors]** key.
- 5 Set the Y2 cursor to the top of the signal, and set Y1 to the bottom of the signal.

Note the ΔY value at the bottom of the display. In this example, we are using the Y cursors, but you could have used the X cursors instead.

- 6 Move the Y1 and Y2 cursors to the intersection of the signal and the Y axis. Again, note the ΔY value.

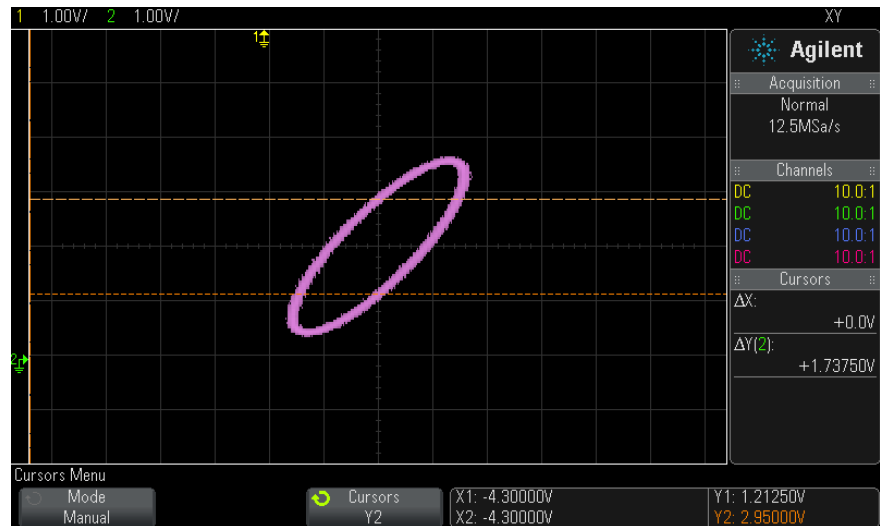

Figure 4 Phase difference measurements, automatic and using cursors

- 7 Calculate the phase difference using the formula below.

For example, if the first ΔY value is 1.688 and the second ΔY value is 1.031:

$$\sin\theta = \frac{\text{second } \Delta Y}{\text{first } \Delta Y} = \frac{1.031}{1.688}; \theta = 37.65 \text{ degrees of phase shift}$$

NOTE

Z-Axis Input in XY Display Mode (Blanking)

When you select the XY display mode, the time base is turned off. Channel 1 is the X-axis input, channel 2 is the Y-axis input, and the rear panel EXT TRIG IN is the Z-axis input. If you only want to see portions of the Y versus X display, use the Z-axis input. Z-axis turns the trace on and off (analog oscilloscopes called this Z-axis blanking because it turned the beam on and off). When Z is low (<1.4 V), Y versus X is displayed; when Z is high (>1.4 V), the trace is turned off.

To display the zoomed time base

Zoom, formerly called Delayed sweep mode, is a horizontally expanded version of the normal display. When Zoom is selected, the display divides in half. The top half of the display shows the normal time/div window and the bottom half displays a faster Zoom time/div window.

The Zoom window is a magnified portion of the normal time/div window. You can use Zoom to locate and horizontally expand part of the normal window for a more detailed (higher-resolution) analysis of signals.

To turn on (or off) Zoom:

- 1 Press the  zoom key (or press the **[Horiz]** key and then the **Zoom** softkey).

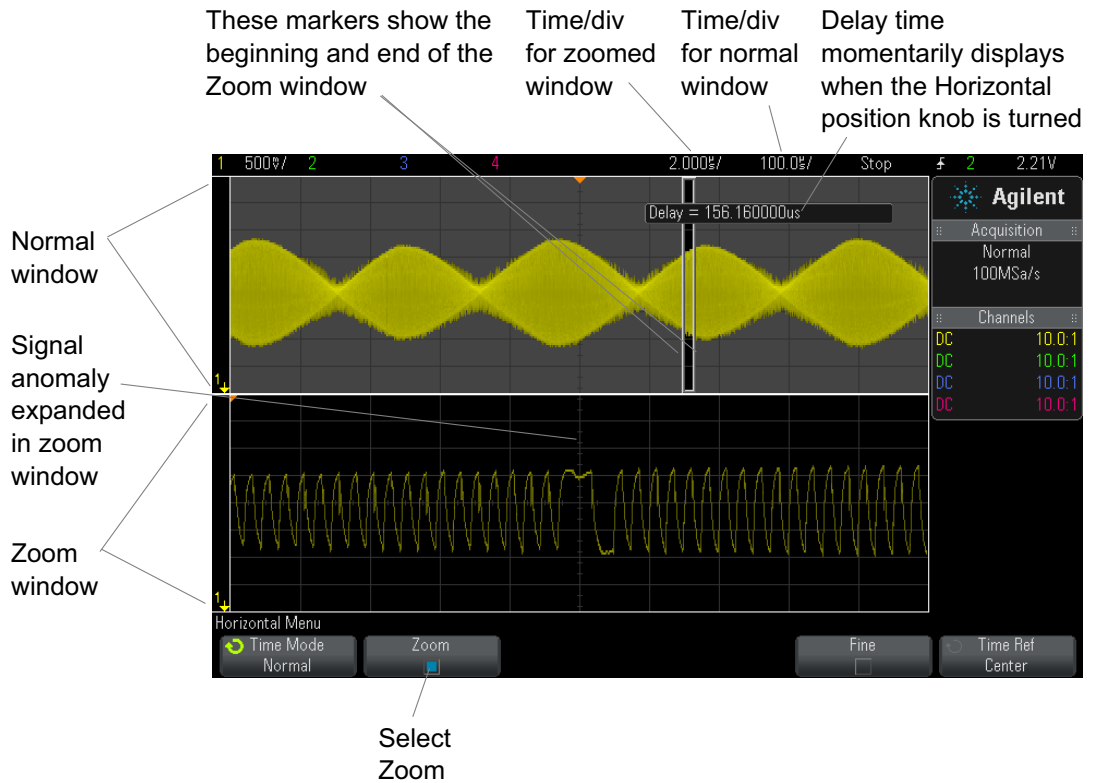

The area of the normal display that is expanded is outlined with a box and the rest of the normal display is ghosted. The box shows the portion of the normal sweep that is expanded in the lower half.

To change the time/div for the Zoom window, turn the horizontal scale (sweep speed) knob. As you turn the knob, the zoomed window time/div is highlighted in the status line above the waveform display area. The Horizontal scale (sweep speed) knob controls the size of the box.

The Horizontal position (delay time) knob sets the left-to-right position of the zoom window. The delay value, which is the time displayed relative to the trigger point) is momentarily displayed in the upper-right portion of the display when the delay time (◀▶) knob is turned.

Negative delay values indicate you're looking at a portion of the waveform before the trigger event, and positive values indicate you're looking at the waveform after the trigger event.

To change the time/div of the normal window, turn off Zoom; then, turn the horizontal scale (sweep speed) knob.

For information about using zoom mode for measurements, refer to ["To isolate a pulse for Top measurement"](#) on page 222 and ["To isolate an event for frequency measurement"](#) on page 228.

To change the horizontal scale knob's coarse/fine adjustment setting

- 1 Push the horizontal scale knob (or press **[Horiz] > Fine**) to toggle between fine and coarse adjustment of the horizontal scale.

When **Fine** is enabled, turning the horizontal scale knob changes the time/div (displayed in the status line at the top of the display) in smaller increments. The time/div remains fully calibrated when **Fine** is on.

When **Fine** is turned off, the Horizontal scale knob changes the time/div setting in a 1-2-5 step sequence.

To position the time reference (left, center, right)

Time reference is the reference point on the display for delay time (horizontal position).

- 1 Press **[Horiz]**.
- 2 In the Horizontal Menu, press **Time Ref**; then, select:
 - **Left** – the time reference is set to one major division from the left edge of the display.
 - **Center** – the time reference is set to the center of the display.
 - **Right** – the time reference is set to one major division from the right edge of the display.

A small hollow triangle (∇) at the top of the display grid marks the position of the time reference. When delay time is set to zero, the trigger point indicator (▼) overlays the time reference indicator.

The time reference position sets the initial position of the trigger event within acquisition memory and on the display, with delay set to 0.

Turning the Horizontal scale (sweep speed) knob expands or contracts the waveform about the time reference point (∇). See ["To adjust the horizontal \(time/div\) scale"](#) on page 50.

Turning the Horizontal position (◀▶) knob in Normal mode (not Zoom) moves the trigger point indicator (▼) to the left or right of the time reference point (∇). See ["To adjust the horizontal delay \(position\)"](#) on page 51.

Searching for Events

You can use the **[Search]** key and menu to search for Edge, Pulse Width, Rise/Fall Time, Runt, and Serial events on the analog channels.

Setting up searches (see ["To set up searches"](#) on page 59) is similar to setting up triggers. In fact, except for Serial events, you can copy search setups to trigger setups and vice-versa (see ["To copy search setups"](#) on page 60).

Searches are different than triggers in that they use the measurement threshold settings instead of trigger levels.

Found search events are marked with white triangles at the top of the graticule, and the number of events found is displayed in the menu line just above the sofkey labels.

To set up searches

- 1 Press **[Search]**.
- 2 In the Search Menu, press **Search**; then, turn the Entry knob to select the search type.
- 3 Press **Settings**, and use the Search Settings Menu to set up the selected search type.

Setting up searches is similar to setting up triggers:

- For setting up Edge searches, see ["Edge Trigger"](#) on page 146.

- For setting up Pulse Width searches, see ["Pulse Width Trigger"](#) on page 149.
- For setting up Rise/Fall Time searches, see ["Rise/Fall Time Trigger"](#) on page 157.
- For setting up Runt searches, see ["Runt Trigger"](#) on page 160.
- For setting up Serial searches, see [Chapter 10](#), "Triggers," starting on page 143 and ["Searching Lister Data"](#) on page 128.

Remember that searches use the measurement threshold settings instead of trigger levels. Use the **Thresholds** softkey in the Search Menu to access the Measurement Threshold Menu. See ["Measurement Thresholds"](#) on page 236.

To copy search setups

Except for Serial event search setups, you can copy search setups to trigger setups and vice-versa.

- 1 Press [**Search**].
- 2 In the Search Menu, press **Search**; then, turn the Entry knob to select the search type.
- 3 Press **Copy**.
- 4 In the Search Copy Menu:
 - Press **Copy to Trigger** to copy the setup for the selected search type to the same trigger type. For example, if the current search type is Pulse Width, pressing **Copy to Trigger** copies the search settings to the Pulse Width trigger settings and selects the Pulse Width trigger.
 - Press **Copy from Trigger** to copy the trigger setup for the selected search type to the search setup.
 - To undo a copy, press **Undo Copy**.

The softkeys in the Search Copy Menu may not be available when one of the settings cannot be copied or there is no trigger type that corresponds to the search type.



Navigating the Time Base

You can use the [**Navigate**] key and controls to navigate through:

- Captured data (see ["To navigate time"](#) on page 61).
- Search events (see ["To navigate search events"](#) on page 61).
- Segments, when segmented memory acquisitions are turned on (see ["To navigate segments"](#) on page 62).

To navigate time

When acquisitions are stopped, you can use the navigation controls to play through the captured data.

- 1 Press **[Navigate]**.
- 2 In the Navigate Menu, press **Navigate**; then, select **Time**.
- 3 Press the  navigation keys to play backward, stop, or play forward in time. You can press the  or  keys multiple times to speed up the playback. There are three speed levels.

To navigate search events

When acquisitions are stopped, you can use the navigation controls to go to found search events (set using the **[Search]** key and menu, see ["Searching for Events"](#) on page 59).

- 1 Press **[Navigate]**.
- 2 In the Navigate Menu, press **Navigate**; then, select **Search**.
- 3 Press the  back and forward keys to go to the previous or next search event.

When searching Serial decode:

- You can press the  stop key to set or clear a mark.
- The **Auto zoom** softkey specifies whether the waveform display is automatically zoomed to fit the marked row as you navigate.
- Pressing the **Scroll Lister** softkey lets you use the Entry knob to scroll through data rows in the Lister display.

To navigate segments

When the segmented memory acquisition is enabled and acquisitions are stopped, you can use the navigation controls to play through the acquired segments.

1 Press **[Navigate]**.

2 In the Navigate Menu, press **Navigate**; then, select **Segments**.

3 Press **Play Mode**; then, select:

- **Manual** – to play through segments manually.

In the Manual play mode:

- Press the ◀▶ back and forward keys to go to the previous or next segment.
- Press the ◀ softkey to go to the first segment.
- Press the ▶ softkey to go to the last segment.
- **Auto** – to play through segments in an automated fashion.

In the Auto play mode:

- Press the ◀■▶ navigation keys to play backward, stop, or play forward in time. You can press the ◀ or ▶ keys multiple times to speed up the playback. There are three speed levels.

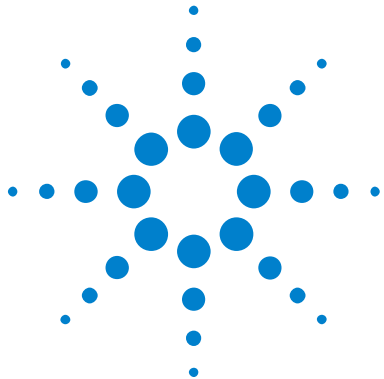

3 Vertical Controls

- To turn waveforms on or off (channel or math) [64](#)
- To adjust the vertical scale [65](#)
- To adjust the vertical position [65](#)
- To specify channel coupling [65](#)
- To specify channel input impedance [66](#)
- To specify bandwidth limiting [67](#)
- To change the vertical scale knob's coarse/fine adjustment setting [67](#)
- To invert a waveform [68](#)
- Setting Analog Channel Probe Options [68](#)

The vertical controls include:

- The vertical scale and position knobs for each analog channel.
- The channel keys for turning a channel on or off and accessing the channel's softkey menu.

The following figure shows the Channel 1 Menu that appears after pressing the [1] channel key.



3 Vertical Controls

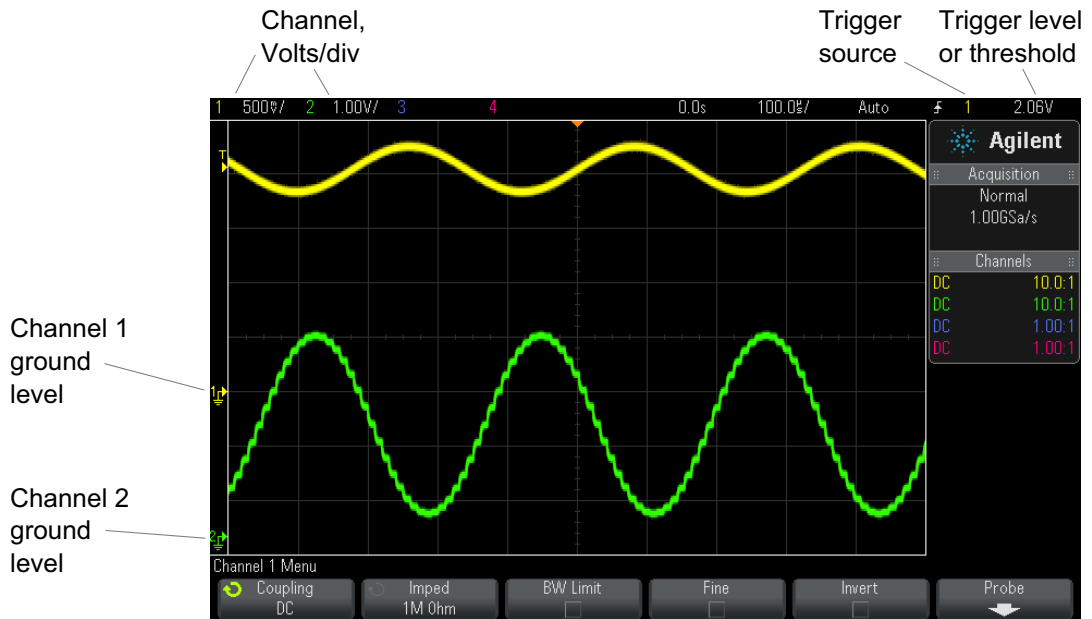

The ground level of the signal for each displayed analog channel is identified by the position of the  icon at the far-left side of the display.

To turn waveforms on or off (channel or math)

- 1 Press an analog channel key turn the channel on or off (and to display the channel's menu).

When a channel is on, its key is illuminated.

NOTE

Turning channels off

You must be viewing the menu for a channel before you can turn it off. For example, if channel 1 and channel 2 are turned on and the menu for channel 2 is being displayed, to turn channel 1 off, press [1] to display the channel 1 menu; then, press [1] again to turn channel 1 off.

To adjust the vertical scale

- 1 Turn the large knob above the channel key marked  to set the vertical scale (volts/division) for the channel.

The vertical scale knob changes the analog channel scale in a 1-2-5 step sequence (with a 1:1 probe attached) unless fine adjustment is enabled (see "To change the vertical scale knob's coarse/fine adjustment setting" on page 67).

The analog channel Volts/Div value is displayed in the status line.

The default mode for expanding the signal when you turn the volts/division knob is vertical expansion about the ground level of the channel; however, you can change this to expand about the center of the display. See "To choose "expand about" center or ground" on page 301.

To adjust the vertical position

- 1 Turn the small vertical position knob () to move the channel's waveform up or down on the display.

The voltage value momentarily displayed in the upper right portion of the display represents the voltage difference between the vertical center of the display and the ground level () icon. It also represents the voltage at the vertical center of the display if vertical expansion is set to expand about ground (see "To choose "expand about" center or ground" on page 301).

To specify channel coupling

Coupling changes the channel's input coupling to either **AC** (alternating current) or **DC** (direct current).

TIP

If the channel is DC coupled, you can quickly measure the DC component of the signal by simply noting its distance from the ground symbol.

If the channel is AC coupled, the DC component of the signal is removed, allowing you to use greater sensitivity to display the AC component of the signal.

- 1 Press the desired channel key.
- 2 In the Channel Menu, press the **Coupling** softkey to select the input channel coupling:
 - **DC** – DC coupling is useful for viewing waveforms as low as 0 Hz that do not have large DC offsets.
 - **AC** – AC coupling is useful for viewing waveforms with large DC offsets.

When AC coupling is chosen, you cannot select 50 Ω mode. This is done to prevent damage to the oscilloscope.

AC coupling places a 10 Hz high-pass filter in series with the input waveform that removes any DC offset voltage from the waveform.

Note that Channel Coupling is independent of Trigger Coupling. To change trigger coupling see "[To select the trigger coupling](#)" on page 182.

To specify channel input impedance

NOTE

When you connect an AutoProbe, self-sensing probe, or a compatible InfiniiMax probe, the oscilloscope automatically configures the analog input channels to the correct impedance.

- 1 Press the desired channel key.
- 2 In the Channel Menu, press **Imped** (impedance); then, select either:
 - **50 Ohm** – matches 50 ohm cables commonly used in making high frequency measurements, and 50 ohm active probes.

When **50 Ohm** input impedance is selected, it is displayed with the channel information on-screen.

When AC coupling is selected (see "To specify channel coupling" on page 65) or excessive voltage is applied to the input, the oscilloscope automatically switches to **1M Ohm** mode to prevent possible damage.

- **1M Ohm** – is for use with many passive probes and for general-purpose measurements. The higher impedance minimizes the loading effect of the oscilloscope on the device under test.

This impedance matching gives you the most accurate measurements because reflections are minimized along the signal path.

- See Also**
- For more information on probing, visit: "www.agilent.com/find/scope_probes"
 - Information about selecting a probe can be found in document number "*Agilent Oscilloscope Probes and Accessories Selection Guide* (part number 5989-6162EN)", available at "www.agilent.com".

To specify bandwidth limiting

- 1 Press the desired channel key.
- 2 In the Channel Menu, press the **BW Limit** softkey to enable or disable bandwidth limiting.

When bandwidth limit is on, the maximum bandwidth for the channel is approximately 20 MHz. For waveforms with frequencies below this, turning bandwidth limit on removes unwanted high frequency noise from the waveform. The bandwidth limit also limits the trigger signal path of any channel that has **BW Limit** turned on.

To change the vertical scale knob's coarse/fine adjustment setting

- 1 Push the channel's vertical scale knob (or press the channel key and then the **Fine** softkey in the Channel Menu) to toggle between fine and coarse adjustment of the vertical scale.

When **Fine** adjustment is selected, you can change the channel's vertical sensitivity in smaller increments. The channel sensitivity remains fully calibrated when **Fine** is on.

3 Vertical Controls

The vertical scale value is displayed in the status line at the top of the display.

When **Fine** is turned off, turning the volts/division knob changes the channel sensitivity in a 1-2-5 step sequence.

To invert a waveform

- 1 Press the desired channel key.
- 2 In the Channel Menu, press the **Invert** softkey to invert the selected channel.

When **Invert** is selected, the voltage values of the displayed waveform are inverted.

Invert affects how a channel is displayed. However, when using basic triggers, the oscilloscope attempts to maintain the same trigger point by changing trigger settings.

Inverting a channel also changes the result of any math function selected in the Waveform Math Menu or any measurement.

Setting Analog Channel Probe Options

- 1 Press the probe's associated channel key.
- 2 In the Channel Menu, press the **Probe** softkey to display the Channel Probe Menu.

This menu lets you select additional probe parameters such as attenuation factor and units of measurement for the connected probe.



The Channel Probe Menu changes depending on the type of probe connected.

For passive probes (such as the N2862A/B, N2863A/B, N2889A, N2890A, 10073C, 10074C, or 1165A probes), the **Probe Check** softkey appears; it guides you through the process of compensating probes.

For some active probes (such as InfiniiMax probes), the oscilloscope can accurately calibrate its analog channels for the probe. When you connect a probe that can be calibrated, the **Calibrate Probe** softkey appears (and the probe attenuation softkey may change). See "[To calibrate a probe](#)" on page 70.

- See Also**
- "[To specify the channel units](#)" on page 69
 - "[To specify the probe attenuation](#)" on page 69
 - "[To specify the probe skew](#)" on page 70

To specify the channel units

- 1 Press the probe's associated channel key.
- 2 In the Channel Menu, press **Probe**.
- 3 In the Channel Probe Menu, press **Units**; then, select:
 - **Volts** – for a voltage probe.
 - **Amps** – for a current probe.

Channel sensitivity, trigger level, measurement results, and math functions will reflect the measurement units you have selected.

To specify the probe attenuation

This is set automatically if the oscilloscope can identify the connected probe. See Analog channel inputs (see [page 41](#)).

The probe attenuation factor must be set properly for accurate measurement results.

If you connect a probe that is not automatically identified by the oscilloscope, you can manually set the attenuation factor as follows:

- 1 Press the channel key.
- 2 Press the **Probe** softkey until you have selected how you want to specify the attenuation factor, choosing either **Ratio** or **Decibels**.

3 Vertical Controls

- 3 Turn the Entry knob  to set the attenuation factor for the connected probe.

When measuring voltage values, the attenuation factor can be set from 0.1:1 to 1000:1 in a 1-2-5 sequence.

When measuring current values with a current probe, the attenuation factor can be set from 10 V/A to 0.001 V/A.

When specifying the attenuation factor in decibels, you can select values from -20 dB to 60 dB.

If Amps is chosen as the units and a manual attenuation factor is chosen, then the units as well as the attenuation factor are displayed above the **Probe** softkey.



To specify the probe skew

When measuring time intervals in the nanoseconds (ns) range, small differences in cable length can affect the measurement. Use **Skew** to remove cable-delay errors between any two channels.

- 1 Probe the same point with both probes.
- 2 Press one of the probes associated channel key.
- 3 In the Channel Menu, press **Probe**.
- 4 In the Channel Probe Menu, press **Skew**; then, select the desired skew value.

Each analog channel can be adjusted ± 100 ns in 10 ps increments for a total of 200 ns difference.

The skew setting is not affected by pressing [**Default Setup**] or [**Auto Scale**].

To calibrate a probe

The **Calibrate Probe** softkey guides you through the process of calibrating probes.

For certain active probes, such as InfiniiMax probes, the oscilloscope can accurately calibrate its analog channels for the probe. When you connect a probe that can be calibrated, the **Calibrate Probe** softkey in the Channel Probe Menu becomes active.

To calibrate one of these probes:

- 1 First, plug your probe into one of the oscilloscope channels.

This could be, for example, an InfiniiMax probe amplifier/probe head with attenuators attached.

- 2 Connect the probe to the left side, Demo 2, Probe Comp terminal, and the probe ground to the ground terminal.

NOTE

When calibrating a differential probe, connect the positive lead to the Probe Comp terminal and the negative lead to the ground terminal. You may need to connect an alligator clip to the ground lug to allow a differential probe to span between the Probe Comp test point and ground. A good ground connection ensures the most accurate probe calibration.

- 3 Press the Channel on/off key to turn the channel on (if the channel is off).
- 4 In the Channel Menu, press the **Probe** softkey.
- 5 In the Channel Probe Menu, the second softkey from the left is for specifying your probe head (and attenuation). Repeatedly press this softkey until the probe head selection matches the attenuator you are using.

The choices are:

- 10:1 single-ended browser (no attenuator).
- 10:1 differential browser (no attenuator).
- 10:1 (+6 dB Atten) single-ended browser.
- 10:1 (+6 dB Atten) differential browser.
- 10:1 (+12 dB Atten) single-ended browser.
- 10:1 (+12 dB Atten) differential browser.
- 10:1 (+20 dB Atten) single-ended browser.
- 10:1 (+20 dB Atten) differential browser.

- 6 Press the **Calibrate Probe** softkey and follow the instructions on the display.

3 Vertical Controls

For more information on InfiniiMax probes and accessories, see the probe's *User's Guide*.



4 Math Waveforms

- To display math waveforms [73](#)
- To perform transforms or filters on an arithmetic operation [75](#)
- To adjust the math waveform scale and offset [75](#)
- Units for Math Waveforms [76](#)
- Math Operators [76](#)
- Math Transforms [78](#)
- Math Filters [94](#)
- Math Visualizations [96](#)

Math functions can be performed on analog channels. The resulting math waveform is displayed in light purple.

You can use a math function on a channel even if you choose not to display the channel on-screen.

You can:

- Perform an arithmetic operation (like add, subtract, or multiply) on analog input channels.
- Perform a transform function (like differentiate, integrate, FFT, or square root) on an analog input channel.
- Perform a transform function on the result of an arithmetic operation.

To display math waveforms

- 1 Press the **[Math]** key on the front panel to display the Waveform Math Menu.





- 2 If $f(t)$ is not already shown on the **Function** softkey, press the **Function** softkey and select **f(t): Displayed**.
- 3 Use the **Operator** softkey to select an operator or transform.
For more information on the operators, see:
 - "Math Operators" on page 76
 - "Math Transforms" on page 78
 - "Math Filters" on page 94
 - "Math Visualizations" on page 96
- 4 Use the **Source 1** softkey to select the analog channel on which to perform math. You can rotate the Entry knob or repetitively press the **Source 1** softkey to make your selection. If you choose a transform function (differentiate, integrate, FFT, or square root) the result is displayed.
- 5 If you select an arithmetic operator, use the **Source 2** softkey to select the second source for the arithmetic operation. The result is displayed.
- 6 To re-size and re-position the math waveform, see "To adjust the math waveform scale and offset" on page 75.

TIP

Math Operating Hints

If the analog channel or math function is clipped (not fully displayed on screen) the resulting displayed math function will also be clipped.

Once the function is displayed, the analog channel(s) may be turned off for better viewing of the math waveform.

The vertical scaling and offset of each math function can be adjusted for ease of viewing and measurement considerations.

The math function waveform can be measured using [**Cursors**] and/or [**Meas**].

To perform transforms or filters on an arithmetic operation

To perform a transform function (see "Math Transforms" on page 78) or filter (see "Math Filters" on page 94) on the add, subtract, or multiply arithmetic operations:

- 1 Press the **Function** softkey and select **g(t): Internal**.
- 2 Use the **Operator**, **Source 1**, and **Source 2** softkeys to set up an arithmetic operation.
- 3 Press the **Function** softkey and select **f(t): Displayed**.
- 4 Use the **Operator** softkey to select a transform function or filter.
- 5 Press the **Source 1** softkey and select **g(t)** as the source. Note that **g(t)** is only available when you select a transform function in the previous step.

To adjust the math waveform scale and offset

- 1 Make sure the multiplexed scale and position knobs to the right of the **[Math]** key are selected for the math waveform.

If the arrow to the left of the **[Math]** key is not illuminated, press the key.

- 2 Use the multiplexed scale and position knobs just to the right of the **[Math]** key to re-size and re-position the math waveform.

NOTE

Math Scale and Offset are Set Automatically

Any time the currently displayed math function definition is changed, the function is automatically scaled for optimum vertical scale and offset. If you manually set scale and offset for a function, select a new function, then select the original function, the original function will be automatically rescaled.

See Also • "Units for Math Waveforms" on page 76

Units for Math Waveforms

Units for each input channel can be set to Volts or Amps using the **Units** softkey in the channel's Probe Menu. Units for math function waveforms are:

Math function	Units
add or subtract	V or A
multiply	V^2 , A^2 , or W (Volt-Amp)
d/dt	V/s or A/s (V/second or A/second)
$\int dt$	Vs or As (V-seconds or A-seconds)
FFT	dB* (decibels). See also "FFT Units" on page 88.
$\sqrt{\text{square root}}$	$V^{1/2}$, $A^{1/2}$, or $W^{1/2}$ (Volt-Amp)
* When the FFT source is channel 1, 2, 3 or 4, FFT units will be displayed in dBV when channel units is set to Volts and channel impedance is set to 1 M Ω . FFT units will be displayed in dBm when channel units is set to Volts and channel impedance is set to 50 Ω . FFT units will be displayed as dB for all other FFT sources or when a source channel's units has been set to Amps.	

A scale unit of **U** (undefined) will be displayed for math functions when two source channels are used and they are set to dissimilar units and the combination of units cannot be resolved.

Math Operators

Math operators perform arithmetic operations (like add, subtract, or multiply) on analog input channels.

- "Add or Subtract" on page 77
- "Multiply or Divide" on page 77

Add or Subtract

When you select add or subtract, the **Source 1** and **Source 2** values are added or subtracted point by point, and the result is displayed.

You can use subtract to make a differential measurement or to compare two waveforms.

If your waveforms' DC offsets are larger than the dynamic range of the oscilloscope's input channels you will need to use a differential probe instead.

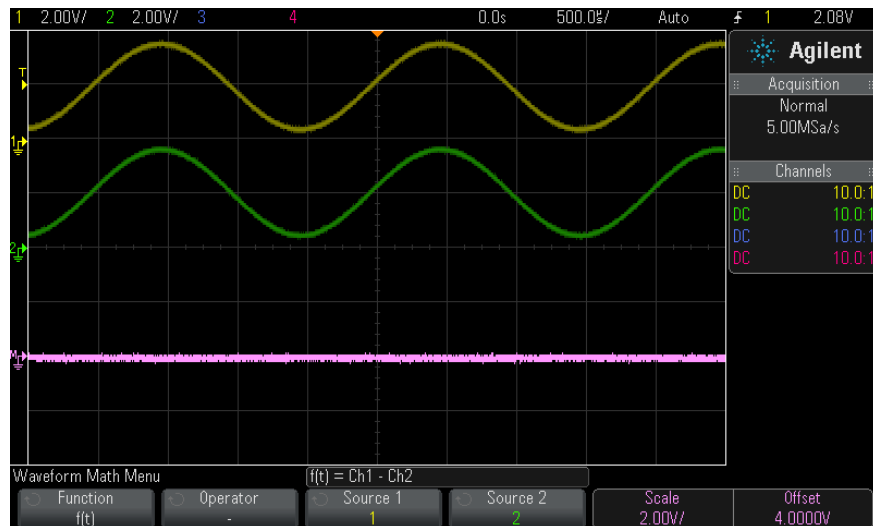

Figure 5 Example of Subtract Channel 2 from Channel 1

See Also • ["Units for Math Waveforms"](#) on page 76

Multiply or Divide

When you select the multiply or divide math function, the **Source 1** and **Source 2** values are multiplied or divided point by point, and the result is displayed.

4 Math Waveforms

The divide by zero case places holes (that is, zero values) in the output waveform.

Multiply is useful for seeing power relationships when one of the channels is proportional to the current.

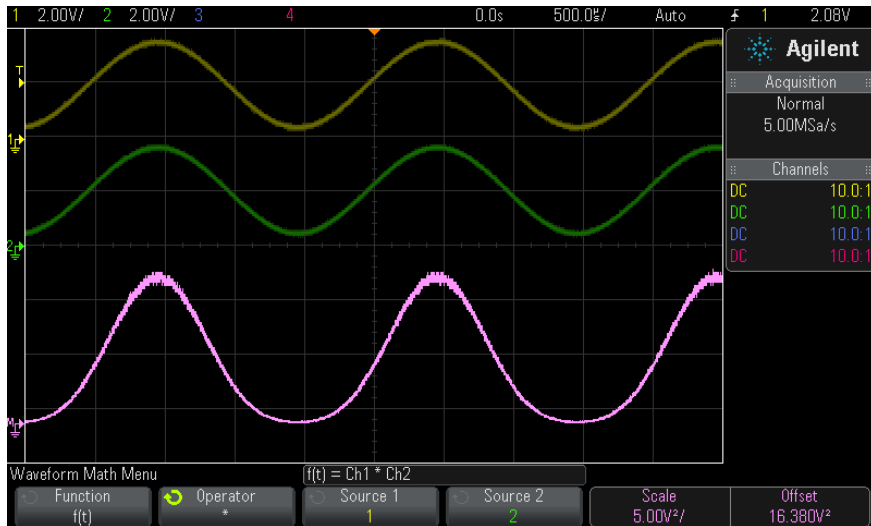

Figure 6 Example of Multiply Channel 1 by Channel 2

See Also • ["Units for Math Waveforms"](#) on page 76

Math Transforms

Math transforms perform a transform function (like differentiate, integrate, FFT, or square root) on an analog input channel or on the result of an arithmetic operation.

- ["Differentiate"](#) on page 79
- ["Integrate"](#) on page 80
- ["FFT Measurement"](#) on page 83
- ["Square Root"](#) on page 90

With the DSOX3ADVMATH advanced math measurements license, these additional transforms are available:

- "Ax + B" on page 90
- "Square" on page 91
- "Absolute Value" on page 92
- "Common Logarithm" on page 92
- "Natural Logarithm" on page 93
- "Exponential" on page 93
- "Base 10 Exponential" on page 94

Differentiate

d/dt (differentiate) calculates the discrete time derivative of the selected source.

You can use differentiate to measure the instantaneous slope of a waveform. For example, the slew rate of an operational amplifier may be measured using the differentiate function.

Because differentiation is very sensitive to noise, it is helpful to set acquisition mode to **Averaging** (see "Selecting the Acquisition Mode" on page 193).

d/dt plots the derivative of the selected source using the "average slope estimate at 4 points" formula. The equation is:

$$d_i = \frac{y_{i+4} + 2y_{i+2} - 2y_{i-2} - y_{i-4}}{8 \Delta t}$$

Where:

- d = differential waveform.
- y = channel 1, 2, 3, or 4, or g(t) (internal arithmetic operation) data points.
- i = data point index.
- Δt = point-to-point time difference.

4 Math Waveforms

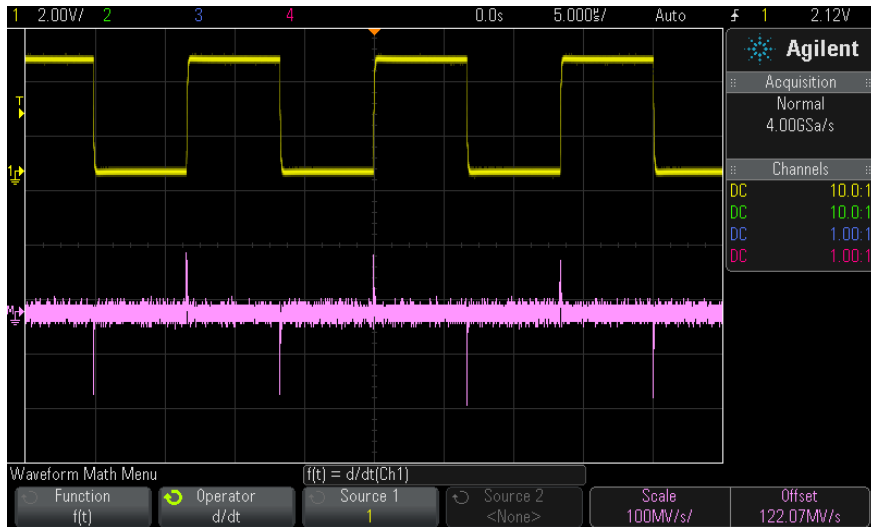

Figure 7 Example of Differentiate Function

- See Also**
- ["To perform transforms or filters on an arithmetic operation" on page 75](#)
 - ["Units for Math Waveforms" on page 76](#)

Integrate

$\int dt$ (integrate) calculates the integral of the selected source. You can use integrate to calculate the energy of a pulse in volt-seconds or measure the area under a waveform.

$\int dt$ plots the integral of the source using the "Trapezoidal Rule". The equation is:

$$I_n = c_o + \Delta t \sum_{i=0}^n y_i$$

Where:

- I = integrated waveform.

- Δt = point-to-point time difference.
- y = channel 1, 2, 3, or 4, or $g(t)$ (internal arithmetic operation).
- co = arbitrary constant.
- i = data point index.

The integrate operator provides an **Offset** softkey that lets you enter a DC offset correction factor for the input signal. Small DC offset in the integrate function input (or even small oscilloscope calibration errors) can cause the integrate function output to "ramp" up or down. This DC offset correction lets you level the integrate waveform.

4 Math Waveforms

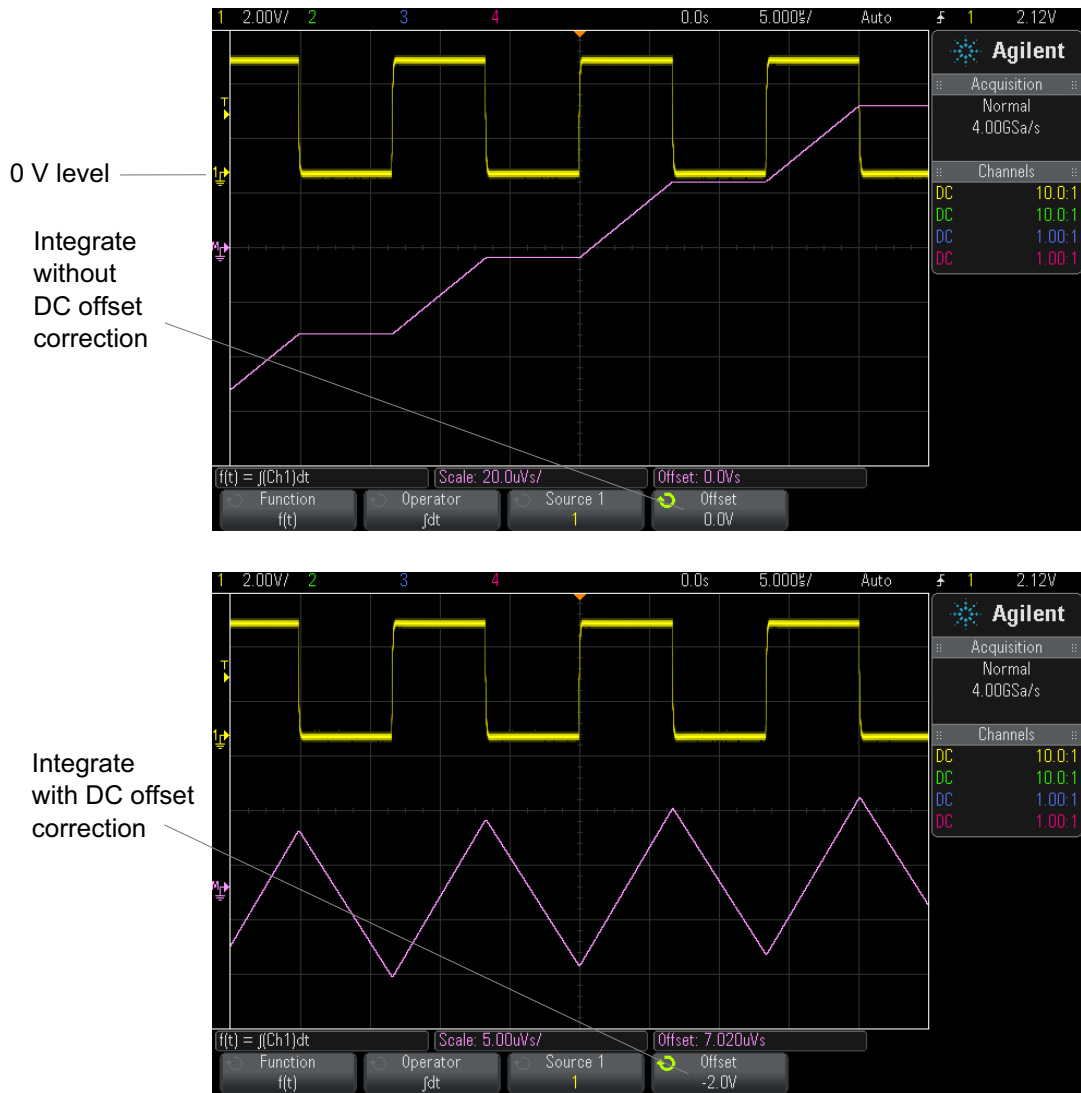

Figure 8 Integrate and Signal Offset

See Also • "To perform transforms or filters on an arithmetic operation" on page 75

- "Units for Math Waveforms" on page 76

FFT Measurement

FFT is used to compute the fast Fourier transform using analog input channels or an arithmetic operation $g(t)$. FFT takes the digitized time record of the specified source and transforms it to the frequency domain. When the FFT function is selected, the FFT spectrum is plotted on the oscilloscope display as magnitude in dBV versus frequency. The readout for the horizontal axis changes from time to frequency (Hertz) and the vertical readout changes from volts to dB.

Use the FFT function to find crosstalk problems, to find distortion problems in analog waveforms caused by amplifier non-linearity, or for adjusting analog filters.

To display a FFT waveform:

- 1 Press the **[Math]** key, press the **Function** softkey and select **f(t)**, press the **Operator** softkey and select **FFT**.



- **Source 1** – selects the source for the FFT. (See "To perform transforms or filters on an arithmetic operation" on page 75 for information about using $g(t)$ as the source.)
- **Span** – sets the overall width of the FFT spectrum that you see on the display (left to right). Divide span by 10 to calculate the number of Hertz per division. It is possible to set Span above the maximum available frequency, in which case the displayed spectrum will not take up the whole screen. Press the **Span** softkey, then turn the Entry knob to set the desired frequency span of the display.
- **Center** – sets the FFT spectrum frequency represented at the center vertical grid line of the display. It is possible to set the Center to values below half the span or above the maximum available frequency, in which case the displayed spectrum will not take up the whole screen. Press the **Center** softkey, then turn the Entry knob to set the desired center frequency of the display.

- **Scale** – lets you set your own vertical scale factors for FFT expressed in dB/div (decibels/division). See "To adjust the math waveform scale and offset" on page 75.
 - **Offset** – lets you set your own offset for the FFT. The offset value is in dB and is represented by the center horizontal grid line of the display. See "To adjust the math waveform scale and offset" on page 75.
 - **More FFT** – displays the More FFT Settings Menu.
- 2 Press the **More FFT** softkey to display additional FFT settings.



- **Window**– selects a window to apply to your FFT input signal:
 - **Hanning** – window for making accurate frequency measurements or for resolving two frequencies that are close together.
 - **Flat Top** – window for making accurate amplitude measurements of frequency peaks.
 - **Rectangular** – good frequency resolution and amplitude accuracy, but use only where there will be no leakage effects. Use on self-windowing waveforms such as pseudo-random noise, impulses, sine bursts, and decaying sinusoids.
 - **Blackman Harris** – window reduces time resolution compared to a rectangular window, but improves the capacity to detect smaller impulses due to lower secondary lobes.
- **Vertical Units** – lets you select Decibels or V RMS as the units for the FFT vertical scale.
- **Auto Setup** – sets the frequency Span and Center to values that will cause the entire available spectrum to be displayed. The maximum available frequency is half the FFT sample rate, which is a function of the time per division setting. The FFT resolution is the quotient of the sampling rate and the number of FFT points (f_s/N). The current FFT Resolution is displayed above the softkeys.

NOTE

Scale and offset considerations

If you do not manually change the FFT scale or offset settings, when you turn the horizontal scale knob, the span and center frequency settings will automatically change to allow optimum viewing of the full spectrum.

If you do manually set scale or offset, turning the horizontal scale knob will not change the span or center frequency settings, allowing you see better detail around a specific frequency.

Pressing the FFT **Auto Setup** softkey will automatically rescale the waveform and span and center will again automatically track the horizontal scale setting.

- 3** To make cursor measurements, press the [**Cursors**] key and set the **Source** softkey to **Math: f(t)**.

Use the X1 and X2 cursors to measure frequency values and difference between two frequency values (ΔX). Use the Y1 and Y2 cursors to measure amplitude in dB and difference in amplitude (ΔY).

- 4** To make other measurements, press the [**Meas**] key and set the **Source** softkey to **Math: f(t)**.

You can make peak-to-peak, maximum, minimum, and average dB measurements on the FFT waveform. You can also find the frequency value at the first occurrence of the waveform maximum by using the X at Max Y measurement.

The following FFT spectrum was obtained by connecting a 4 V, 75 kHz square wave to channel 1. Set the horizontal scale to 50 $\mu\text{s}/\text{div}$, vertical sensitivity to 1 V/div, Units/div to 20 dBV, Offset to -60.0 dBV, Center frequency to 250 kHz, frequency Span to 500 kHz, and window to Hanning.



- See Also**
- "To perform transforms or filters on an arithmetic operation" on page 75
 - "FFT Measurement Hints" on page 86
 - "FFT Units" on page 88
 - "FFT DC Value" on page 88
 - "FFT Aliasing" on page 88
 - "FFT Spectral Leakage" on page 89
 - "Units for Math Waveforms" on page 76

FFT Measurement Hints

The number of points acquired for the FFT record can be up to 65,536, and when frequency span is at maximum, all points are displayed. Once the FFT spectrum is displayed, the frequency span and center frequency controls are used much like the controls of a spectrum analyzer to examine the frequency of interest in greater detail. Place the desired part of the waveform at the center of the screen and decrease frequency span to increase the display resolution. As frequency span is decreased, the number of points shown is reduced, and the display is magnified.

While the FFT spectrum is displayed, use the **[Math]** and **[Cursors]** keys to switch between measurement functions and frequency domain controls in FFT Menu.

NOTE**FFT Resolution**

The FFT resolution is the quotient of the sampling rate and the number of FFT points (f_s/N). With a fixed number of FFT points (up to 65,536), the lower the sampling rate, the better the resolution.

Decreasing the effective sampling rate by selecting a greater time/div setting will increase the low frequency resolution of the FFT display and also increase the chance that an alias will be displayed. The resolution of the FFT is the effective sample rate divided by the number of points in the FFT. The actual resolution of the display will not be this fine as the shape of the window will be the actual limiting factor in the FFT's ability to resolve two closely spaced frequencies. A good way to test the ability of the FFT to resolve two closely spaced frequencies is to examine the sidebands of an amplitude modulated sine wave.

For the best vertical accuracy on peak measurements:

- Make sure the probe attenuation is set correctly. The probe attenuation is set from the Channel Menu if the operand is a channel.
- Set the source sensitivity so that the input signal is near full screen, but not clipped.
- Use the Flat Top window.
- Set the FFT sensitivity to a sensitive range, such as 2 dB/division.

For best frequency accuracy on peaks:

- Use the Hanning window.
- Use Cursors to place an X cursor on the frequency of interest.
- Adjust frequency span for better cursor placement.
- Return to the Cursors Menu to fine tune the X cursor.

For more information on the use of FFTs please refer to Agilent Application Note 243, *The Fundamentals of Signal Analysis* at "<http://cp.literature.agilent.com/litweb/pdf/5952-8898E.pdf>". Additional information can be obtained from Chapter 4 of the book *Spectrum and Network Measurements* by Robert A. Witte.

FFT Units

0 dBV is the amplitude of a 1 V_{rms} sinusoid. When the FFT source is channel 1 or channel 2 (or channel 3 or 4 on 4-channel models), FFT units will be displayed in dBV when channel units is set to Volts and channel impedance is set to 1 M Ω .

FFT units will be displayed in dBm when channel units is set to Volts and channel impedance is set to 50 Ω .

FFT units will be displayed as dB for all other FFT sources or when a source channel's units has been set to Amps.

FFT DC Value

The FFT computation produces a DC value that is incorrect. It does not take the offset at center screen into account. The DC value is not corrected in order to accurately represent frequency components near DC.

FFT Aliasing

When using FFTs, it is important to be aware of frequency aliasing. This requires that the operator have some knowledge as to what the frequency domain should contain, and also consider the sampling rate, frequency span, and oscilloscope vertical bandwidth when making FFT measurements. The FFT resolution (the quotient of the sampling rate and the number of FFT points) is displayed directly above the softkeys when the FFT Menu is displayed.

NOTE

Nyquist Frequency and Aliasing in the Frequency Domain

The Nyquist frequency is the highest frequency that any real-time digitizing oscilloscope can acquire without aliasing. This frequency is half of the sample rate. Frequencies above the Nyquist frequency will be under sampled, which causes aliasing. The Nyquist frequency is also called the folding frequency because aliased frequency components fold back from that frequency when viewing the frequency domain.

Aliasing happens when there are frequency components in the signal higher than half the sample rate. Because the FFT spectrum is limited by this frequency, any higher components are displayed at a lower (aliased) frequency.

The following figure illustrates aliasing. This is the spectrum of a 990 Hz square wave, which has many harmonics. The sample rate is set to 100 kSa/s, and the oscilloscope displays the spectrum. The displayed waveform shows the components of the input signal above the Nyquist frequency to be mirrored (aliased) on the display and reflected off the right edge.



Figure 9 Aliasing

Because the frequency span goes from ≈ 0 to the Nyquist frequency, the best way to prevent aliasing is to make sure that the frequency span is greater than the frequencies of significant energy present in the input signal.

FFT Spectral Leakage

The FFT operation assumes that the time record repeats. Unless there is an integral number of cycles of the sampled waveform in the record, a discontinuity is created at the end of the record. This is referred to as leakage. In order to minimize spectral leakage, windows that approach zero smoothly at the beginning and end of the signal are employed as filters to the FFT. The FFT Menu provides four windows: Hanning, Flat

4 Math Waveforms

Top, Rectangular, and Blackman-Harris. For more information on leakage, see Agilent Application Note 243, *The Fundamentals of Signal Analysis* at "<http://cp.literature.agilent.com/litweb/pdf/5952-8898E.pdf>."

Square Root

Square root ($\sqrt{\quad}$) calculates the square root of the selected source.

Where the transform is undefined for a particular input, holes (zero values) appear in the function output.

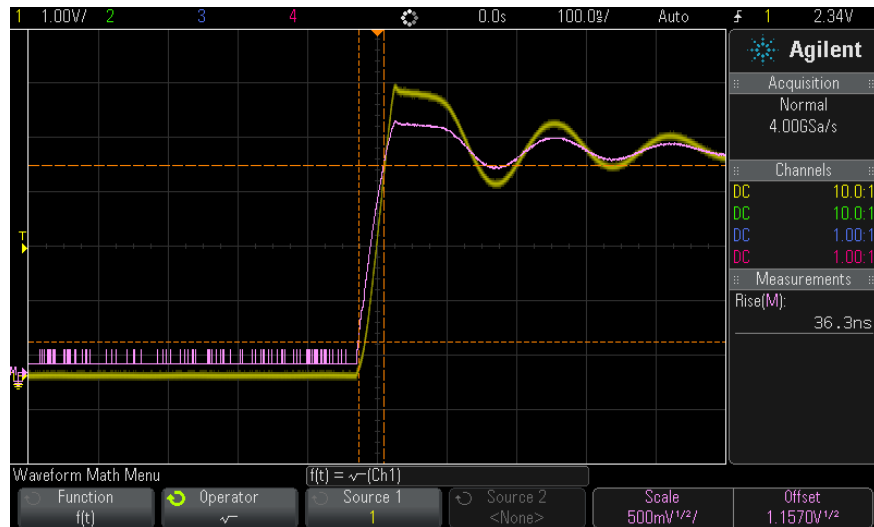

Figure 10 Example of $\sqrt{\quad}$ (Square Root)

- See Also**
- "[To perform transforms or filters on an arithmetic operation](#)" on page 75
 - "[Units for Math Waveforms](#)" on page 76

Ax + B

The Ax + B function (available with the DSOX3ADVMATH advanced math measurements license) lets you apply a gain and offset to an existing input source.

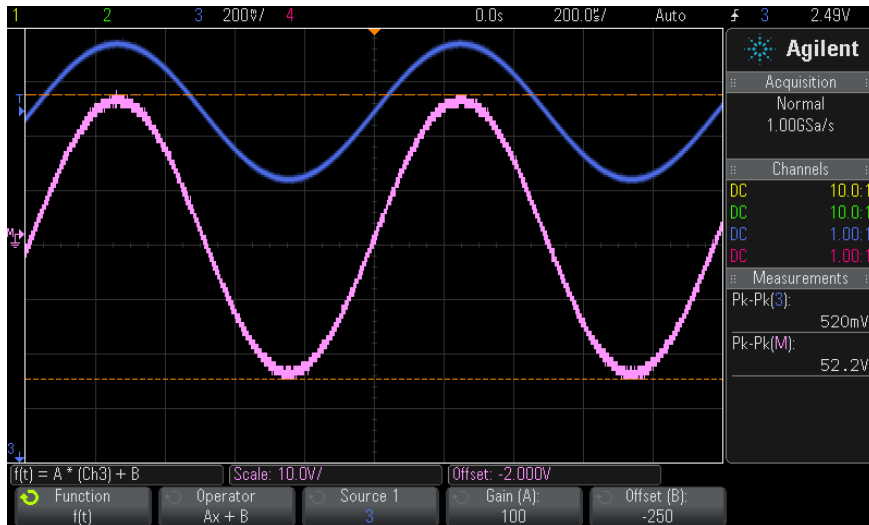

Figure 11 Example of $Ax + B$

Use the **Gain (A)** softkey to specify the gain.

Use the **Offset (B)** softkey to specify the offset.

The $Ax + B$ function differs from the Magnify math visualization function in that the output is likely different than the input.

See Also • ["Magnify"](#) on page 96

Square

The square function (available with the DSOX3ADVMATH advanced math measurements license) calculates the square of the selected source, point by point, and displays the result.

Press the **Source** softkey to select the signal source.

See Also • ["Square Root"](#) on page 90

Absolute Value

The absolute value function (available with the DSOX3ADVMATH advanced math measurements license) changes negative values in the input to positive values and displays the resulting waveform.

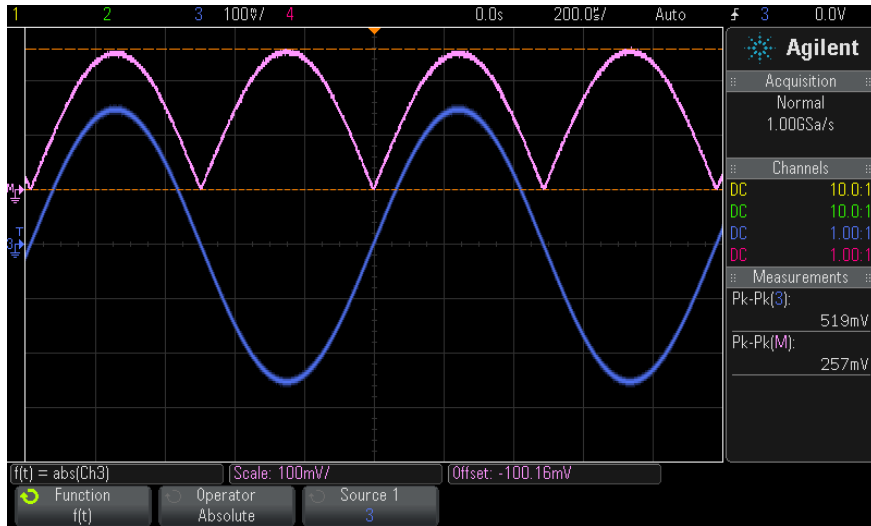

Figure 12 Example of Absolute Value

See Also • ["Square"](#) on page 91

Common Logarithm

The Common Logarithm (log) function (available with the DSOX3ADVMATH advanced math measurements license) performs a transform of the input source. Where the transform is undefined for a particular input, holes (zero values) appear in the function output.

See Also • ["Natural Logarithm"](#) on page 93

Natural Logarithm

The Natural Logarithm (\ln) function (available with the DSOX3ADVMATH advanced math measurements license) performs a transform of the input source. Where the transform is undefined for a particular input, holes (zero values) appear in the function output.

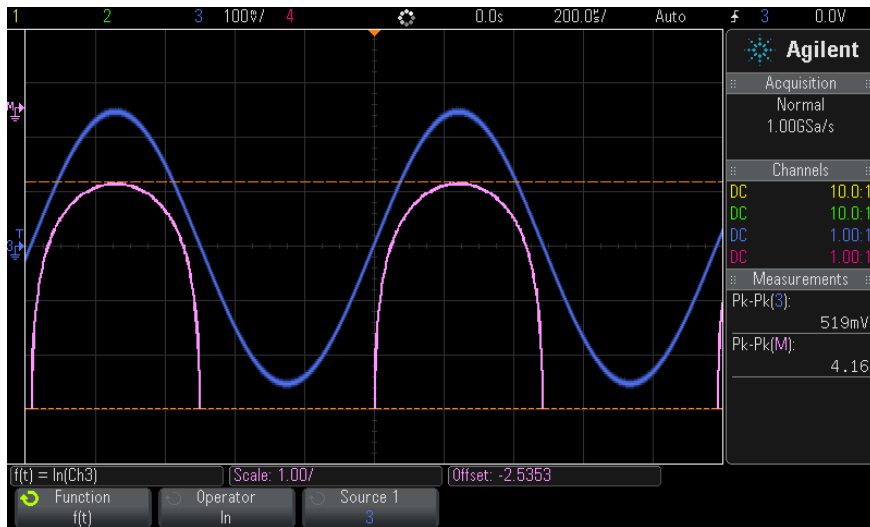

Figure 13 Example of Natural Logarithm

See Also • ["Common Logarithm"](#) on page 92

Exponential

The Exponential (e^x) function (available with the DSOX3ADVMATH advanced math measurements license) performs a transform of the input source.

See Also • ["Base 10 Exponential"](#) on page 94

Base 10 Exponential

The Base 10 Exponential (10^x) function (available with the DSOX3ADVMATH advanced math measurements license) performs a transform of the input source.

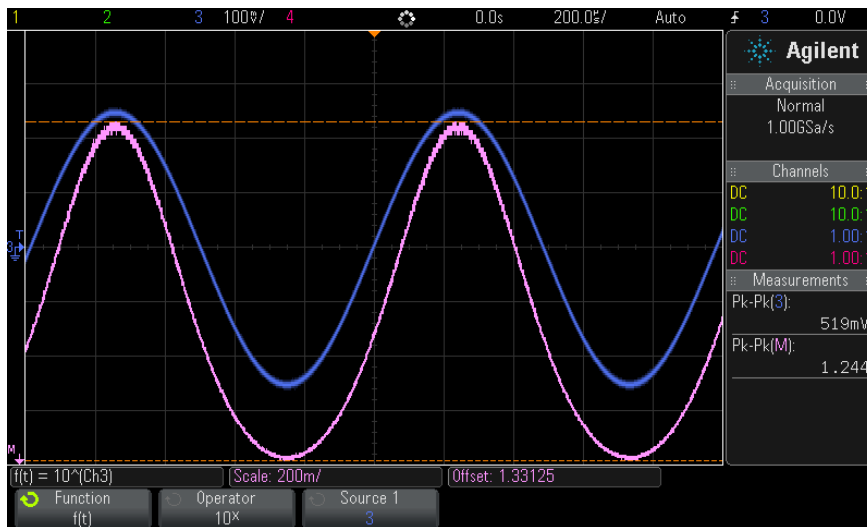

Figure 14 Example of Base 10 Exponential

See Also • ["Exponential"](#) on page 93

Math Filters

With the DSOX3ADVMATH advanced math measurements license, you can use math filters to create a waveform that is the result of a high- or low-pass filter on an analog input channel or on the result of an arithmetic operation.

• ["High Pass and Low Pass Filter"](#) on page 95

High Pass and Low Pass Filter

The high-pass or low-pass filter functions (available with the DSOX3ADVMATH advanced math measurements license) apply the filter to the selected source waveform and display the result in the math waveform.

The high-pass filter is a single-pole high-pass filter.

The low-pass filter is a 4th order Bessel-Thompson filter.

Use the **Bandwidth** softkey to select the filter's -3 dB cutoff frequency.

NOTE

The ratio of the input signal's Nyquist frequency and the selected -3 dB cutoff frequency affects how many points are available in the output, and under some circumstances, there are no points in the output waveform.



Figure 15 Example of Low Pass Filter

Math Visualizations

With the DSOX3ADVMATH advanced math measurements license, you can apply visualization math functions that give you different ways of viewing captured data and measurement values.

- "Magnify" on page 96
- "Measurement Trend" on page 97
- "Chart Logic Bus Timing" on page 98
- "Chart Logic Bus State" on page 99

Magnify

The magnify math function (available with the DSOX3ADVMATH advanced math measurements license) lets you display an existing input source at different vertical settings to provide more vertical detail.

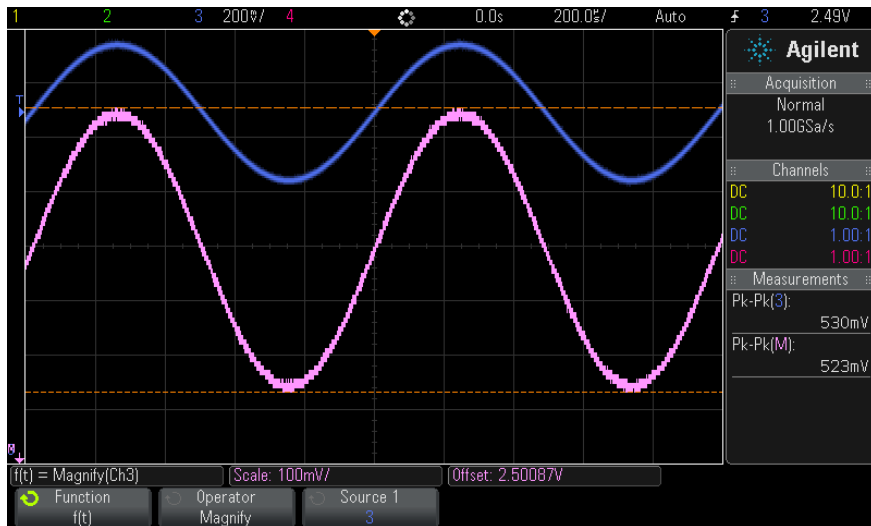

Figure 16 Example of Magnify

See Also • "Ax + B" on page 90

Measurement Trend

The measurement trend math function (available with the DSOX3ADVMATH advanced math measurements license) shows measurement values for a waveform (based on measurement threshold settings) as the waveform progresses across the screen. For every cycle, a measurement is made, and the value is displayed on the screen for the cycle.

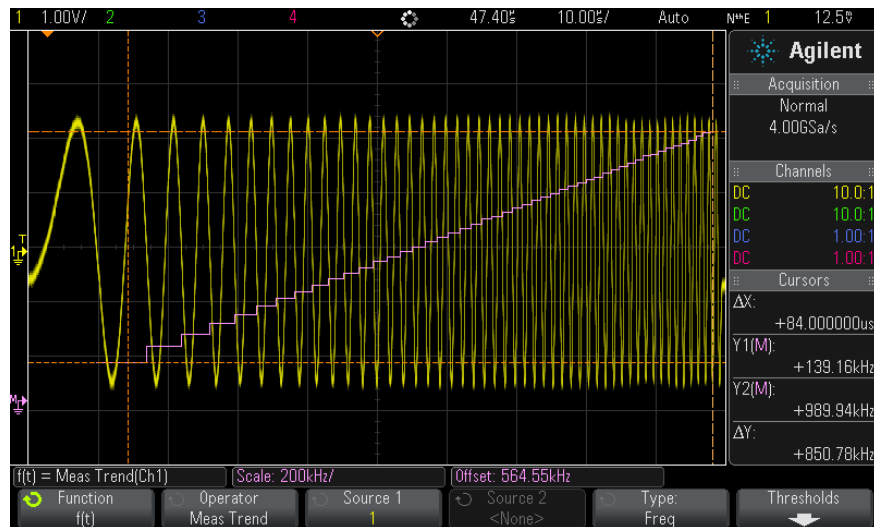

Figure 17 Example of Measurement Trend

Use the **Type:** softkey to select the measurement whose trend you want to look at. You can display trend values for these measurements:

- Average
- RMS - AC
- Ratio
- Period
- Frequency
- +Width
- -Width

4 Math Waveforms

- Duty Cycle
- Rise Time
- Fall Time

Use the **Thresholds** softkey to access the Measurement Threshold Menu. See "[Measurement Thresholds](#)" on page 236.

If a measurement cannot be made for part of a waveform, the trend function output is a hole (that is, no value) until a measurement can be made.

Chart Logic Bus Timing

The Chart Logic Bus Timing function (available with the DSOX3ADVMATH advanced math measurements license) displays bus data values as an analog waveform (like a D/A conversion). When the bus value is transitioning, the function output is the bus's last stable state.

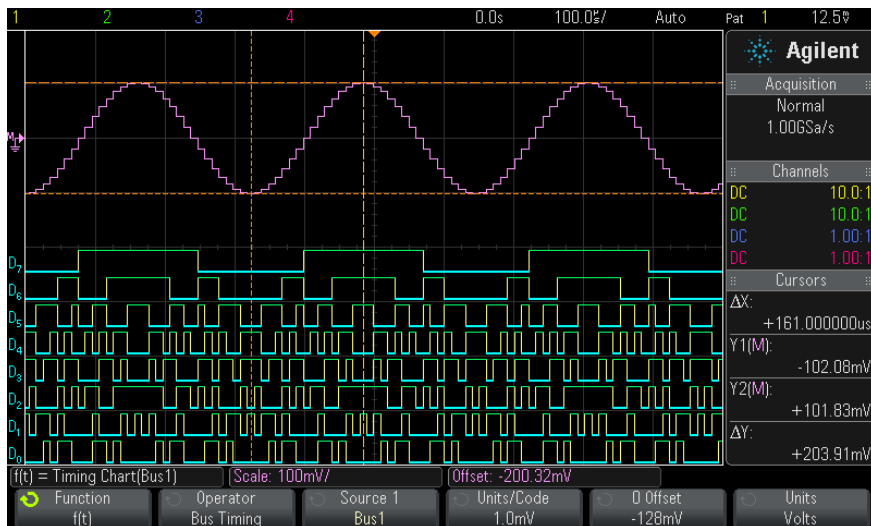

Figure 18 Example of Chart Logic Bus Timing

Use the **Units/Code** softkey to specify the analog value equivalent of each increment in the bus data value.

Use the **0 Offset** softkey to specify the analog value equivalent of a bus data value of zero.

Use the **Units** softkey to specify the type of values the bus data represents (volts, amps, etc.).

See Also • ["Chart Logic Bus State"](#) on page 99

Chart Logic Bus State

The Chart Logic Bus State function (available with the DSOX3ADVMATH advanced math measurements license) displays bus data values, sampled on a clock signal's edge, as an analog waveform (like a D/A conversion).

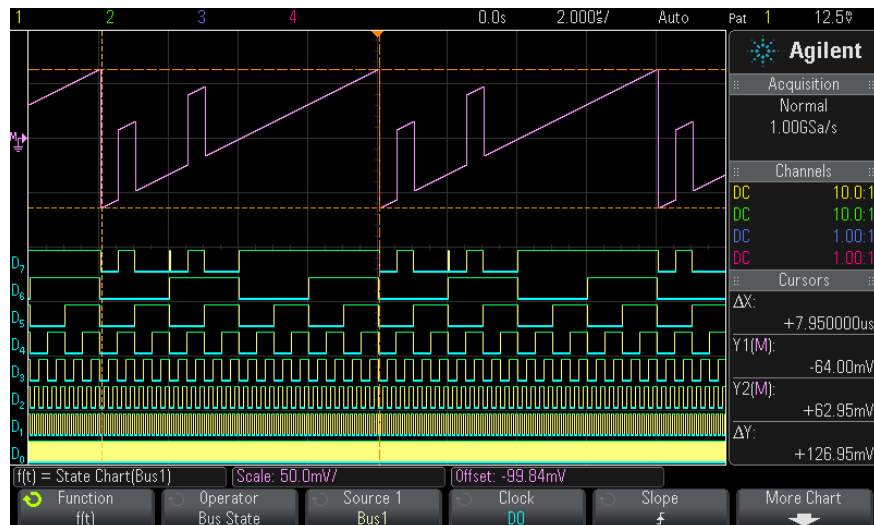

Figure 19 Example of Chart Logic Bus State

Use the **Clock** softkey to select the clock signal.

Use the **Slope** softkey to select the edge of the clock signal to be used.

Use the **More Chart** softkey to open a submenu for specifying the analog value equivalent of each bus value increment, the analog equivalent of a zero bus value, and the type of values the charted bus data represents (volts, amps, etc.).

4 Math Waveforms



Use the **Units/Code** softkey to specify the analog value equivalent of each increment in the bus data value.

Use the **0 Offset** softkey to specify the analog value equivalent of a bus data value of zero.

Use the **Units** softkey to specify the type of values the bus data represents (volts, amps, etc.).

See Also • ["Chart Logic Bus Timing"](#) on page 98



5 Reference Waveforms

- To save a waveform to a reference waveform location 101
- To display a reference waveform 102
- To scale and position reference waveforms 103
- To adjust reference waveform skew 103
- To display reference waveform information 104
- To save/recall reference waveform files to/from a USB storage device 104

Analog channel or math waveforms can be saved to one of two reference waveform locations in the oscilloscope. Then, a reference waveform can be displayed and compared against other waveforms. One reference waveform can be displayed at a time.

When the multiplexed knobs are assigned to reference waveforms (this happens when you press the **[Ref]** key and the LED to the left of it is lit), you can use the knobs to scale and position reference waveforms. There is also a skew adjustment for reference waveforms. Reference waveform scale, offset, and skew information can optionally be included on the oscilloscope display.

Analog channel, math, or reference waveforms can be saved to a reference waveform file on a USB storage device. You can recall a reference waveform file from a USB storage device into one of the reference waveform locations.

To save a waveform to a reference waveform location

- 1 Press the **[Ref]** key to turn on reference waveforms.



5 Reference Waveforms

- 2 In the Reference Waveform Menu, press the **Ref** softkey and turn the Entry knob to select the desired reference waveform location.
- 3 Press the **Source** softkey and turn the Entry knob to select the source waveform.
- 4 Press the **Save to R1/R2** softkey to save the waveform to the reference waveform location.

NOTE

Reference waveforms are non-volatile — they remain after power cycling or performing a default setup.

To clear a reference waveform location

- 1 Press the **[Ref]** key to turn on reference waveforms.
- 2 In the Reference Waveform Menu, press the **Ref** softkey and turn the Entry knob to select the desired reference waveform location.
- 3 Press the **Clear R1/R2** softkey to clear the reference waveform location.

Reference waveforms are also cleared by a Factory Default or Secure Erase (see [Chapter 18](#), “Save/Recall (Setups, Screens, Data),” starting on page 273).

To display a reference waveform

- 1 Press the **[Ref]** key to turn on reference waveforms.
- 2 In the Reference Waveform Menu, press the **Ref** softkey and turn the Entry knob to select the desired reference waveform location.
- 3 Then, press the **Ref** softkey again to enable/disable the reference waveform display.

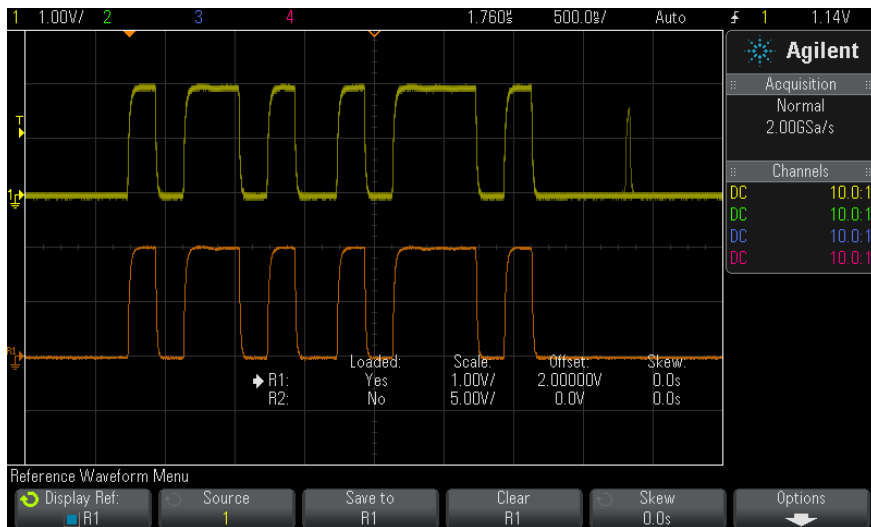

One reference waveform can be displayed at a time.

See Also • ["To display reference waveform information"](#) on page 104

To scale and position reference waveforms

- 1 Make sure the multiplexed scale and position knobs to the right of the **[Ref]** key are selected for the reference waveform.

If the arrow to the left of the **[Ref]** key is not illuminated, press the key.

- 2 Turn the upper multiplexed knob to adjust the reference waveform scale.
- 3 Turn the lower multiplexed knob to adjust the reference waveform position.

To adjust reference waveform skew

Once reference waveforms are displayed, you can adjust their skew.

- 1 Display the desired reference waveform (see ["To display a reference waveform"](#) on page 102).
- 2 Press the **Skew** softkey and turn the Entry knob to adjust the reference waveform skew.

To display reference waveform information

- 1 Press the **[Ref]** key to turn on reference waveforms.
- 2 In the Reference Waveform Menu, press the **Options** softkey.
- 3 In the Reference Waveform Options Menu, press the **Display Info** softkey to enable or disable reference waveform information on the oscilloscope display.
- 4 Press the **Transparent** softkey to enable or disable transparent information backgrounds.

This setting is also used for other oscilloscope information on the display, like mask test statistics, etc.

To save/recall reference waveform files to/from a USB storage device

Analog channel, math, or reference waveforms can be saved to a reference waveform file on a USB storage device. See ["To save reference waveform files to a USB storage device"](#) on page 281.

You can recall a reference waveform file from a USB storage device into one of the reference waveform locations. See ["To recall reference waveform files from a USB storage device"](#) on page 285.



6 Digital Channels

- To connect the digital probes to the device under test [105](#)
- Acquiring waveforms using the digital channels [109](#)
- To display digital channels using AutoScale [109](#)
- Interpreting the digital waveform display [110](#)
- To switch all digital channels on or off [112](#)
- To switch groups of channels on or off [112](#)
- To switch a single channel on or off [112](#)
- To change the displayed size of the digital channels [111](#)
- To reposition a digital channel [113](#)
- To change the logic threshold for digital channels [112](#)
- To display digital channels as a bus [114](#)
- Digital channel signal fidelity: Probe impedance and grounding [117](#)
- To replace digital probe leads [122](#)

This chapter describes how to use the digital channels of a Mixed-Signal Oscilloscope (MSO).

The digital channels are enabled on MSOX3000 X-Series models and DSOX3000 X-Series models that have the MSO upgrade license installed.

To connect the digital probes to the device under test

- 1 If necessary, turn off the power supply to the device under test.



Turning off power to the device under test would only prevent damage that might occur if you accidentally short two lines together while connecting probes. You can leave the oscilloscope powered on because no voltage appears at the probes.

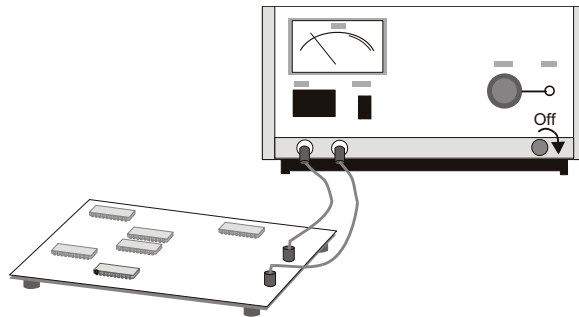

- 2 Connect the digital probe cable to the DIGITAL Dn - D0 connector on the front panel of the mixed-signal oscilloscope. The digital probe cable is keyed so you can connect it only one way. You do not need to power-off the oscilloscope.

CAUTION

Probe cable for digital channels

Use only the Agilent logic probe and accessory kit supplied with the mixed-signal oscilloscope (see "[Accessories Available](#)" on page 338).

- 3 Connect the ground lead on each set of channels (each pod), using a probe grabber. The ground lead improves signal fidelity to the oscilloscope, ensuring accurate measurements.

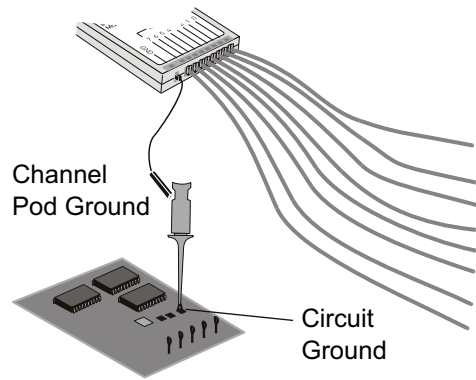

- 4** Connect a grabber to one of the probe leads. (Other probe leads are omitted from the figure for clarity.)

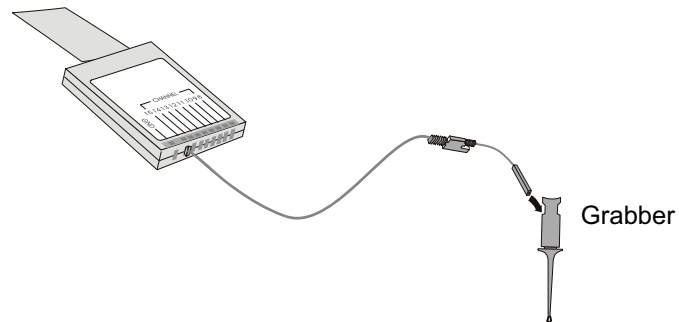

- 5** Connect the grabber to a node in the circuit you want to test.

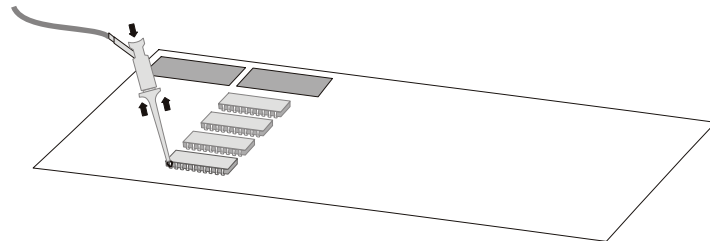

6 Digital Channels

- 6 For high-speed signals, connect a ground lead to the probe lead, connect a grabber to the ground lead, and attach the grabber to ground in the device under test.

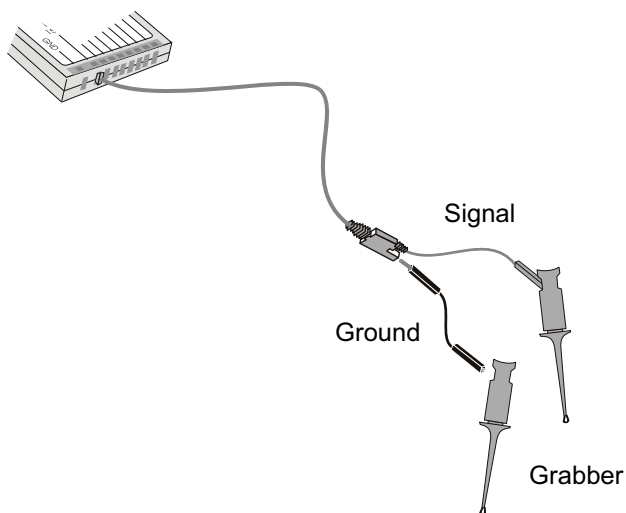

- 7 Repeat these steps until you have connected all points of interest.

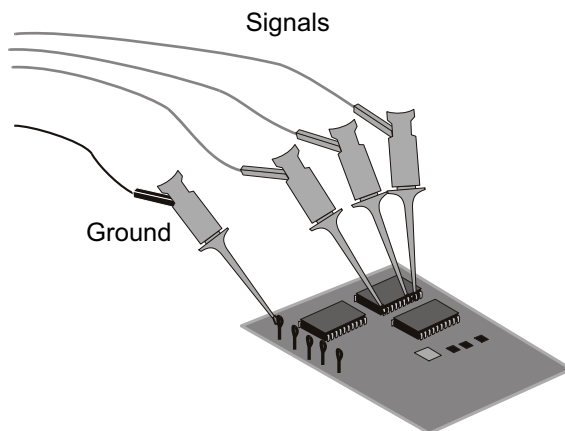

Acquiring waveforms using the digital channels

When you press **[Run/Stop]** or **[Single]** to run the oscilloscope, the oscilloscope examines the input voltage at each input probe. When the trigger conditions are met the oscilloscope triggers and displays the acquisition.

For digital channels, each time the oscilloscope takes a sample it compares the input voltage to the logic threshold. If the voltage is above the threshold, the oscilloscope stores a 1 in sample memory; otherwise, it stores a 0.

To display digital channels using AutoScale

When signals are connected to the digital channels – be sure to connect the ground leads – AutoScale quickly configures and displays the digital channels.

- To configure the instrument quickly, press the **[AutoScale]** key.

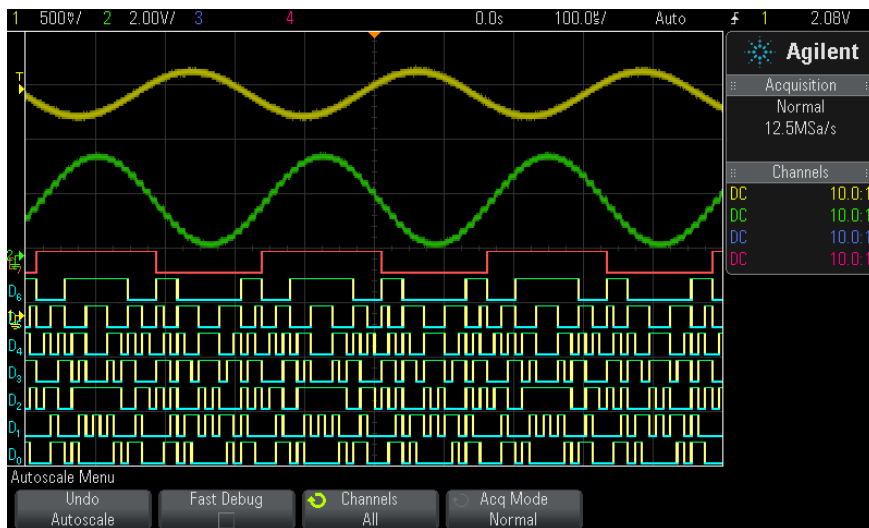

Figure 20 Example: AutoScale of digital channels (MSO models only)

Any digital channel with an active signal will be displayed. Any digital channels without active signals will be turned off.

- To undo the effects of AutoScale, press the **Undo AutoScale** softkey before pressing any other key.

This is useful if you have unintentionally pressed the **[AutoScale]** key or do not like the settings AutoScale has selected. This will return the oscilloscope to its previous settings. See also: "[How AutoScale Works](#)" on page 33.

To set the instrument to the factory-default configuration, press the **[Default Setup]** key.

Interpreting the digital waveform display

The following figure shows a typical display with digital channels.

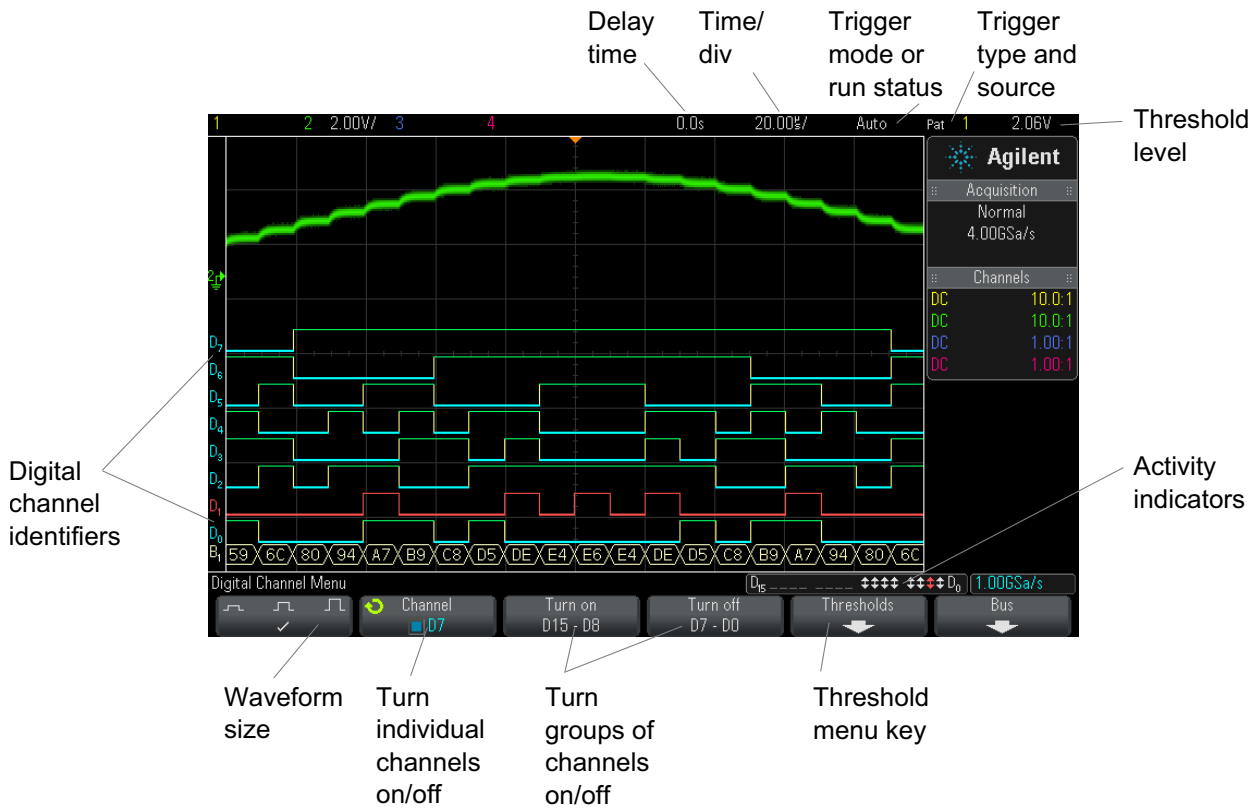

Activity indicator When any digital channels are turned on, an activity indicator is displayed in the status line at the bottom of the display. A digital channel can be always high (■), always low (■), or actively toggling logic states (↑). Any channel that is turned off will be grayed out in the activity indicator.

To change the displayed size of the digital channels

- 1 Press the **[Digital]** key.
- 2 Press the size (□ □ □) softkey to select how the digital channels are displayed.

The sizing control lets you spread out or compress the digital traces vertically on the display for more convenient viewing.

To switch a single channel on or off

- 1 With the Digital Channel Menu displayed, rotate the Entry knob to select the desired channel from the popup menu.
- 2 Push the Entry knob or press the softkey that is directly below the popup menu to switch the selected channel on or off.

To switch all digital channels on or off

- 1 Press the [**Digital**] key to toggle the display of digital channels. The Digital Channel Menu is displayed above the softkeys.

If you want to switch the digital channels off, and the Digital Channel Menu is not already displayed, you must push the [**Digital**] key twice to switch the digital channels off. The first push displays the Digital Channel Menu, and the second push switches the channels off.

To switch groups of channels on or off

- 1 Press the [**Digital**] key on the front panel if the Digital Channel Menu is not already displayed.
- 2 Press the **Turn off** (or **Turn on**) softkey for the **D15 - D8** group or the **D7 - D0** group.

Each time you press the softkey, the softkey's mode toggles between **Turn on** and **Turn off**.

To change the logic threshold for digital channels

- 1 Press the [**Digital**] key so that the Digital Channel Menu is displayed.
- 2 Press the **Thresholds** softkey

- 3 Press the **D15 - D8** or **D7 - D0** softkey, then select a logic family preset or select **User** to define your own threshold.

Logic family	Threshold Voltage
TTL	+1.4 V
CMOS	+2.5 V
ECL	-1.3 V
User	Variable from -8 V to +8 V

The threshold you set applies to all channels within the selected D15 - D8 or D7 - D0 group. Each of the two channel groups can be set to a different threshold if desired.

Values greater than the set threshold are high (1) and values less than the set threshold are low (0).

If the **Thresholds** softkey is set to **User**, press the **User** softkey for the channel group, then turn the Entry knob to set the logic threshold. There is one **User** softkey for each group of channels.

To reposition a digital channel

- 1 Make sure the multiplexed scale and position knobs to the right of the key are selected for digital channels.

If the arrow to the left of the **[Digital]** key is not illuminated, press the key.

- 2 Use the multiplexed Select knob to select the channel.

The selected waveform is highlighted in red.

- 3 Use the multiplexed Position knob to move the selected channel waveform.

If a channel waveform is repositioned over another channel waveform, the indicator at the left edge of the trace will change from **Dnn** designation (where nn is a one or two digit channel number) to **D***. The "*" indicates that two channels are overlaid.

To display digital channels as a bus

Digital channels may be grouped and displayed as a bus, with each bus value displayed at the bottom of the display in hex or binary. You can create up to two buses. To configure and display each bus, press the **[Digital]** key on the front panel. Then press the **Bus** softkey.



Next, select a bus. Rotate the Entry knob, then press the Entry knob or the **Bus1/Bus2** softkey to switch it on.

Use the **Channel** softkey and the Entry knob to select individual channels to be included in the bus. You can rotate the Entry knob and push it or push the softkey to select channels. You can also press the **Select/Deselect D15-D8** and **Select/Deselect D7-D0** softkeys to include or exclude groups of eight channels in each bus.



If the bus display is blank, completely white, or if the display includes "...", you need to expand the horizontal scale to allow space for the data to be shown, or use the cursors to display the values (see ["Using cursors to read bus values"](#) on page 115).

The **Base** softkey lets you choose to display the bus values in hex or binary.

The buses are shown at the bottom of the display.



Bus values can be shown in hex or binary.

Using cursors to read bus values

To read the digital bus value at any point using the cursors:

- 1 Turn on Cursors (by pressing the **[Cursors]** key on the front panel)
- 2 Press the cursor **Mode** softkey and change the mode to **Hex** or **Binary**.
- 3 Press the **Source** softkey and select **Bus1** or **Bus2**.
- 4 Use the Entry knob and the **X1** and **X2** softkeys to position the cursors where you want to read the bus values.

6 Digital Channels

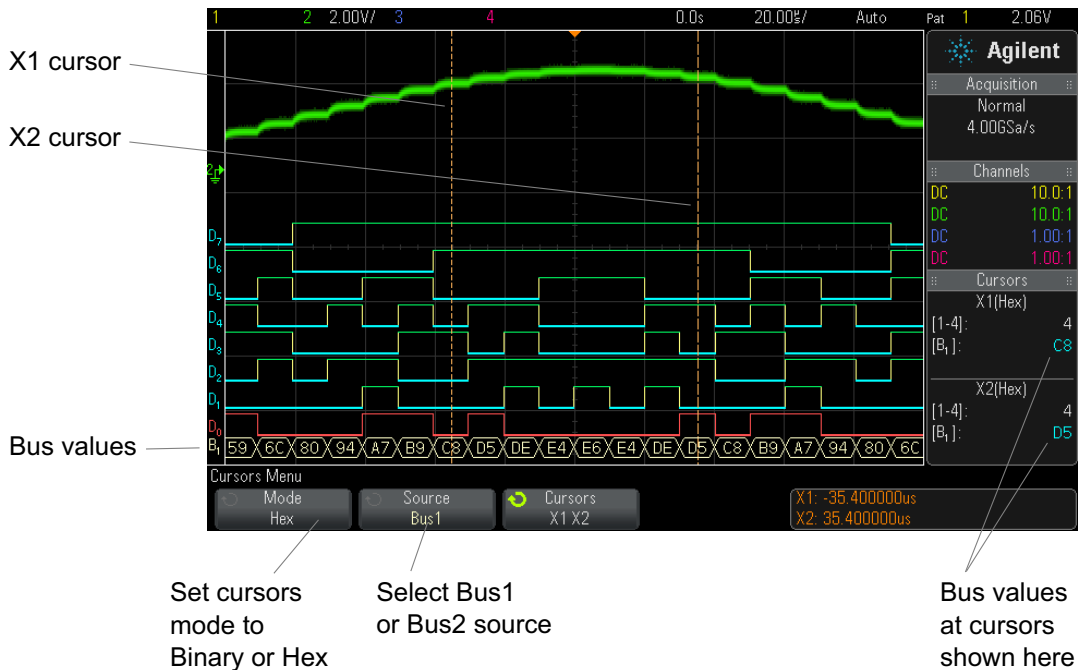

Bus values are displayed when using Pattern trigger

The bus values are also displayed when using the Pattern trigger function. Press the [Pattern] key on the front panel to display the Pattern Trigger Menu and the bus values will be displayed on the right, above the softkeys.

The dollar sign (\$) will be displayed in the bus value when the bus value cannot be displayed as a hex value. This occurs when one or more "don't cares" (X) are combined with low (0) and high (1) logic levels in the pattern specification, or when a transition indicator – rising edge (\uparrow) or falling edge (\downarrow) – are included in the pattern specification. A byte that consists of all don't cares (X) will be displayed in the bus as a don't care (X).

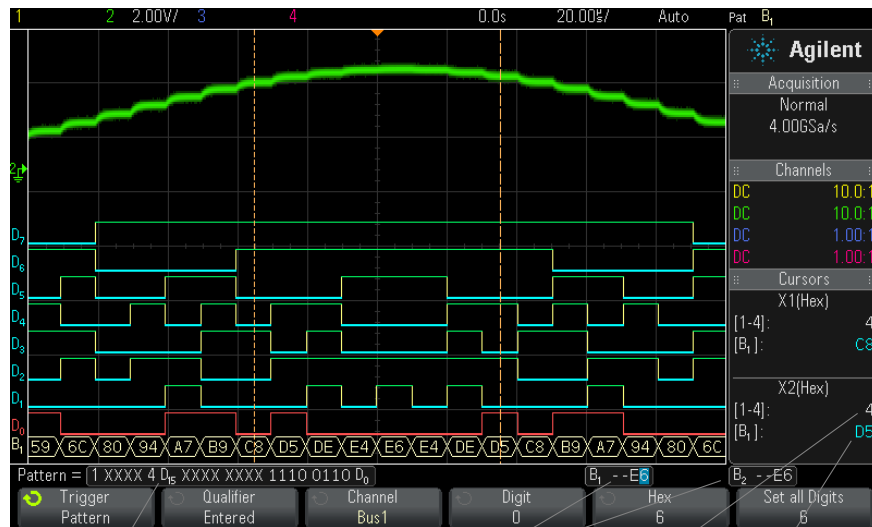

Trigger pattern definition

Bus values displayed

Analog channel values at cursor

Digital channel values at cursor

See "Pattern Trigger" on page 152 for more information on Pattern triggering.

Digital channel signal fidelity: Probe impedance and grounding

When using the mixed-signal oscilloscope you may encounter problems that are related to probing. These problems fall into two categories: probe loading and probe grounding. Probe loading problems generally affect the device under test, while probe grounding problems affect the accuracy of the data to the measurement instrument. The design of the probes minimizes the first problem, while the second is easily addressed by good probing practices.

Input Impedance

The logic probes are passive probes, which offer high input impedance and high bandwidths. They usually provide some attenuation of the signal to the oscilloscope, typically 20 dB.

Passive probe input impedance is generally specified in terms of a parallel capacitance and resistance. The resistance is the sum of the tip resistor value and the input resistance of the test instrument (see the following figure). The capacitance is the series combination of the tip compensating capacitor and the cable, plus instrument capacitance in parallel with the stray tip capacitance to ground. While this results in an input impedance specification that is an accurate model for DC and low frequencies, the high-frequency model of the probe input is more useful (see the following figure). This high-frequency model takes into account pure tip capacitance to ground as well as series tip resistance, and the cable's characteristic impedance (Z_0).

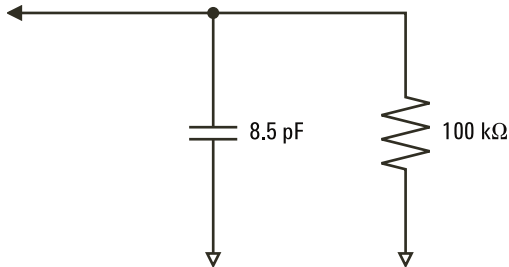

Figure 21 DC and Low-Frequency Probe Equivalent Circuit

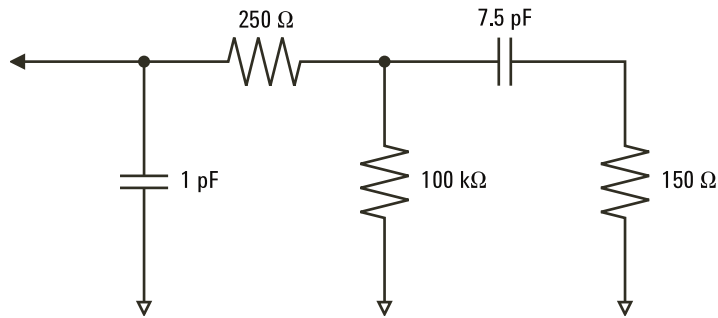

Figure 22 High-Frequency Probe Equivalent Circuit

The impedance plots for the two models are shown in these figures. By comparing the two plots, you can see that both the series tip resistor and the cable's characteristic impedance extend the input impedance significantly. The stray tip capacitance, which is generally small (1 pF), sets the final break point on the impedance chart.

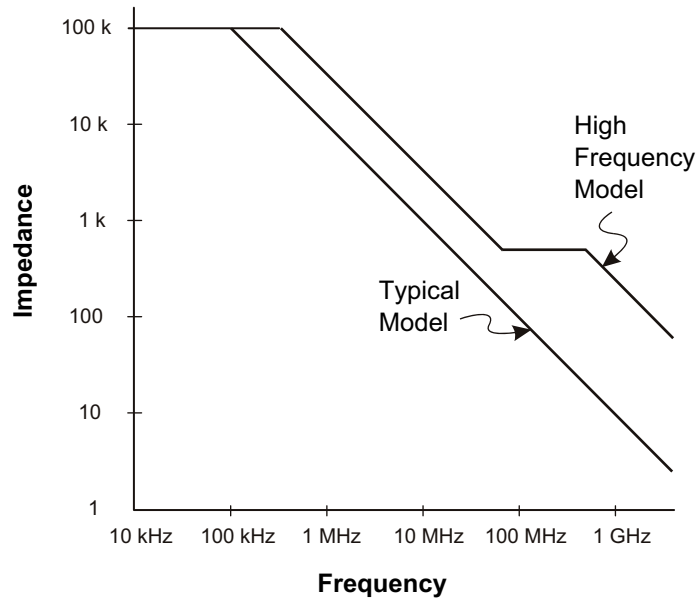

Figure 23 Impedance versus Frequency for Both Probe Circuit Models

The logic probes are represented by the high-frequency circuit model shown above. They are designed to provide as much series tip resistance as possible. Stray tip capacitance to ground is minimized by the proper mechanical design of the probe tip assembly. This provides the maximum input impedance at high frequencies.

Probe Grounding

A probe ground is the low-impedance path for current to return to the source from the probe. Increased length in this path will, at high frequencies, create large common mode voltages at the probe input. The voltage generated behaves as if this path were an inductor according to the equation:

$$V = L \frac{di}{dt}$$

Increasing the ground inductance (L), increasing the current (di) or decreasing the transition time (dt), will all result in increasing the voltage (V). When this voltage exceeds the threshold voltage defined in the oscilloscope, a false data measurement will occur.

Sharing one probe ground with many probes forces all the current that flows into each probe to return through the same common ground inductance of the probe whose ground return is used. The result is increased current (di) in the above equation, and, depending on the transition time (dt), the common mode voltage may increase to a level that causes false data generation.

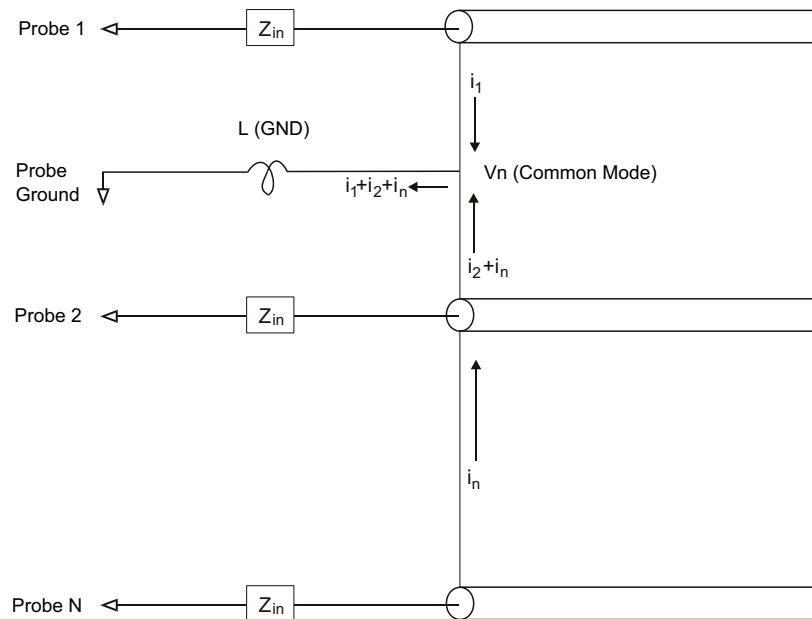

Figure 24 Common Mode Input Voltage Model

In addition to the common mode voltage, longer ground returns also degrade the pulse fidelity of the probe system. Rise time is increased, and ringing, due to the undamped LC circuit at the input of the probe, is also increased. Because the digital channels display reconstructed waveforms, they do not show ringing and perturbations. You will not find ground problems through examination of the waveform display. In fact, it is likely

you will discover the problem through random glitches or inconsistent data measurements. Use the analog channels to view ringing and perturbations.

Best Probing Practices

Because of the variables L , d_i , and d_t , you may be unsure how much margin is available in your measurement setup. The following are guidelines for good probing practices:

- The ground lead from each digital channel group (D15–D8 and D7–D0) should be attached to the ground of the device under test if any channel within the group is being used for data capture.
- When capturing data in a noisy environment, every third digital channel probe's ground should be used in addition to the channel group's ground.
- High-speed timing measurements (rise time < 3 ns) should make use of each digital channel probe's own ground.

When designing a high-speed digital system, you should consider designing dedicated test ports that interface directly to the instrument's probe system. This will ease measurement setup and ensure a repeatable method for obtaining test data. The 01650-61607 16-channel logic probe cable and the 01650-63203 termination adapter are designed to make it easy to connect to industry-standard, 20-pin board connectors. The cable is a 2 m logic analyzer probe cable, and the termination adapter provides the proper RC networks in a very convenient package. These parts, as well as the 1251-8106 20-pin, low-profile, straight board connector, can be ordered from Agilent Technologies.

To replace digital probe leads

If you need to remove a probe lead from the cable, insert a paper clip or other small pointed object into the side of the cable assembly, and push to release the latch while pulling out the probe lead.

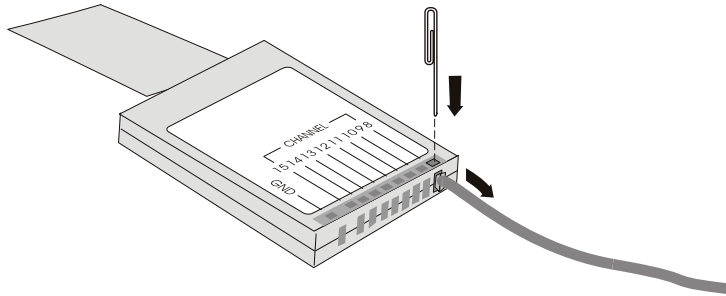
**Table 3** Digital Probe Replacement Parts

Part Number	Description
N6450-60001	Digital probe kit, contains: N6450-61601 16-channel cable, 01650-82103 2-inch probe grounds (qty 5), and 5090-4832 grabbers (qty 20)
N6450-61601	16-channel cable with 16 probe leads and 2 pod ground leads (qty 1)
5959-9333	Replacement probe leads (qty 5), also contains 01650-94309 probe labels
5959-9334	Replacement 2-inch probe grounds (qty 5)
5959-9335	Replacement pod ground leads (qty 5)
5090-4833	Grabbers (qty 20)
01650-94309	Package of probe labels

For other replacement parts, consult the *InfiniiVision 2000/3000 X-Series Oscilloscopes Service Guide*.



7 Serial Decode

Serial Decode Options 125

Lister 126

Searching Lister Data 128

Triggering on Serial Data

In some cases, such as when triggering on a slow serial signal (for example, I2C, SPI, CAN, LIN, etc.) it may be necessary to switch from the Auto trigger mode to the Normal trigger mode to prevent the oscilloscope from Auto-triggering and stabilize the display. You can select the trigger mode by pressing the **[Mode/Coupling]** key, then the **Mode** softkey.

Also, the threshold voltage level must be set appropriately for each source channel. The threshold level for each serial signal can be set in the Signals Menu. Press the **[Serial]** key, then the **Signals** softkey.

Serial Decode Options

Agilent's hardware-accelerated serial decode options can be installed when the oscilloscope is manufactured, or added later. The following serial decode licenses are available:

- With the DSOX3AUTO license, you can decode CAN (Controller Area Network) and LIN (Local Interconnect Network) serial buses. See:
 - ["CAN Serial Decode"](#) on page 355.
 - ["LIN Serial Decode"](#) on page 363.
- With the DSOX3FLEX license, you can decode FlexRay serial buses. See ["FlexRay Serial Decode"](#) on page 371.



- With the DSOX3EMBD license, you can decode I2C (Inter-IC) and SPI (Serial Peripheral Interface) serial buses. See:
 - ["I2C Serial Decode"](#) on page 382.
 - ["SPI Serial Decode"](#) on page 391.
- With the DSOX3AUDIO license, you can decode I2S (Inter-IC Sound or Integrated Interchip Sound) serial buses. See ["I2S Serial Decode"](#) on page 403.
- With the DSOX3COMP license, you can decode many UART (Universal Asynchronous Receiver/Transmitter) protocols including RS232 (Recommended Standard 232). See ["UART/RS232 Serial Decode"](#) on page 427.
- With the DSOX3AERO license, you can decode MIL-STD-1553 and ARINC 429 serial buses. See:
 - ["MIL-STD-1553 Serial Decode"](#) on page 410.
 - ["ARINC 429 Serial Decode"](#) on page 417.

To determine whether these licenses are installed on your oscilloscope, see ["To display oscilloscope information"](#) on page 309.

To order serial decode licenses, go to ["www.agilent.com"](http://www.agilent.com) and search for the product number (for example, DSOX3AUTO) or contact your local Agilent Technologies representative (see ["www.agilent.com/find/contactus"](http://www.agilent.com/find/contactus)).

Lister

Lister is a powerful tool for investigating protocol failures. You can use Lister to view large amounts of packet level serial data in a tabular format, including time tags and specific decoded values. After pressing the **[Single]** key, you can press the **Scroll Lister** softkey and then rotate the Entry knob to select an event and press the **Zoom to Selection** softkey to jump to the event.

To use the Lister:

- 1 Set up trigger and decode on the serial data signals to be analyzed.
- 2 Press **[Serial] > Lister**.
- 3 Press **Display**; then, turn the Entry knob to select the serial slot (**Serial 1** or **Serial 2**) on which the serial bus signals are being decoded. (If you

select **All**, the decode information for different buses is interleaved in time.)

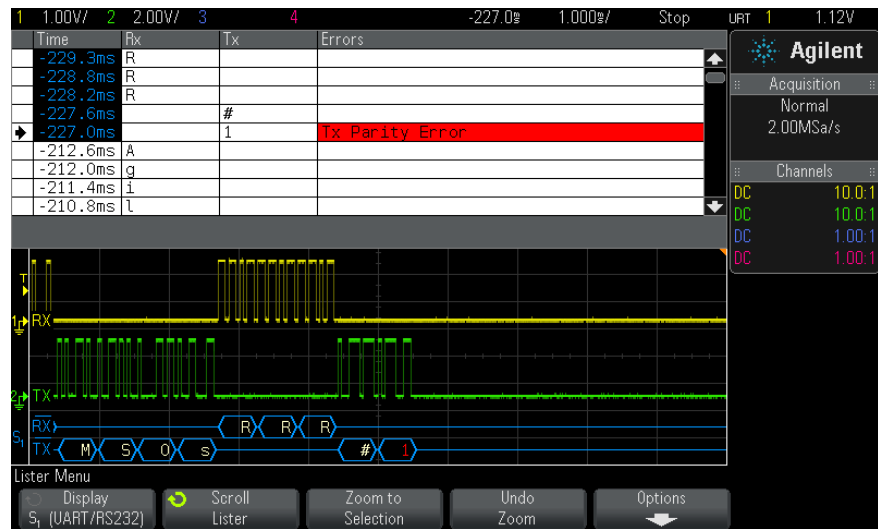

Before you can select a row or navigate through the Lister data, oscilloscope acquisitions must be stopped.

- 4 Press the **[Single]** key (in the Run Control group on the front panel) to stop the acquisition.

Pressing **[Single]** instead of **[Stop]** fills the maximum memory depth.

When zoomed out and viewing a large number of packets, the Lister may not be able to display information for all packets. However, when you press the **[Single]** key the Lister will contain all on-screen serial decode information.

- 5 Press the **Scroll Lister** softkey and use the Entry knob to scroll through the data.

Time tags in the Time column indicate the event time relative to the trigger point. The time tags of events that are shown in the waveform display area are displayed with a dark background.

- 6 Press the **Zoom to Selection** softkey (or push the Entry knob) to center the waveform display at the time associated with the selected Lister row and automatically set the horizontal scale setting.

- 7 Press the **Undo Zoom** softkey to return to the horizontal scale and delay settings before the last **Zoom to Selection**.
- 8 Press the **Options** softkey to open the Lister Options Menu. In this menu, you can:
 - Enable or disable the **Track Time** option. When enabled, as you select different Lister rows (using the Entry knob while acquisitions are stopped), the horizontal delay changes to the Time of the selected row. Also, changing the horizontal delay will scroll the Lister.
 - Press the **Scroll Lister** softkey and use the Entry knob to scroll through data rows in the Lister display.
 - Press the **Time Ref** softkey and use the Entry knob to select whether the Time column in the Lister display shows times relative to the trigger or relative to the previous packet row.

Searching Lister Data

When serial decode is enabled, you can use the [**Search**] key to find and place marks on rows in the Lister.

The **Search** softkey lets you specify events to find. It is similar to specifying protocol triggers.

Events found are marked in orange in the far left Lister column. The total number of events found is displayed above the softkeys.

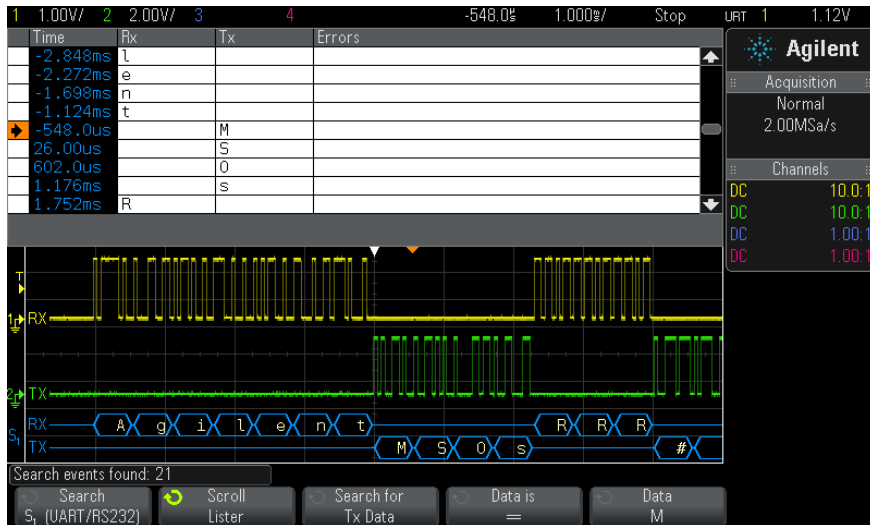

Each serial decode option lets you find protocol-specific headers, data, errors, etc. See:

- ["Searching for ARINC 429 Data in the Lister"](#) on page 421
- ["Searching for CAN Data in the Lister"](#) on page 359
- ["Searching for FlexRay Data in the Lister"](#) on page 374
- ["Searching for I2C Data in the Lister"](#) on page 385
- ["Searching for I2S Data in the Lister"](#) on page 405
- ["Searching for LIN Data in the Lister"](#) on page 366
- ["Searching for MIL-STD-1553 Data in the Lister"](#) on page 413
- ["Searching for SPI Data in the Lister"](#) on page 394
- ["Searching for UART/RS232 Data in the Lister"](#) on page 431



8 Display Settings

To adjust waveform intensity 131

To set or clear persistence 133

To clear the display 134

To select the grid type 134

To adjust the grid intensity 135

To freeze the display 135

To adjust waveform intensity

You can adjust the intensity of displayed waveforms to account for various signal characteristics, such as fast time/div settings and low trigger rates.

Increasing the intensity lets you see the maximum amount of noise and infrequently occurring events.

Reducing the intensity can expose more detail in complex signals as shown in the following figures.

1 Press the **[Intensity]** key to illuminate it.

This key is located just below the Entry knob.

2 Turn the Entry knob to adjust the waveform intensity.

Waveform intensity adjustment affects analog channel waveforms only (not math waveforms, reference waveforms, digital waveforms, etc.).



8 Display Settings

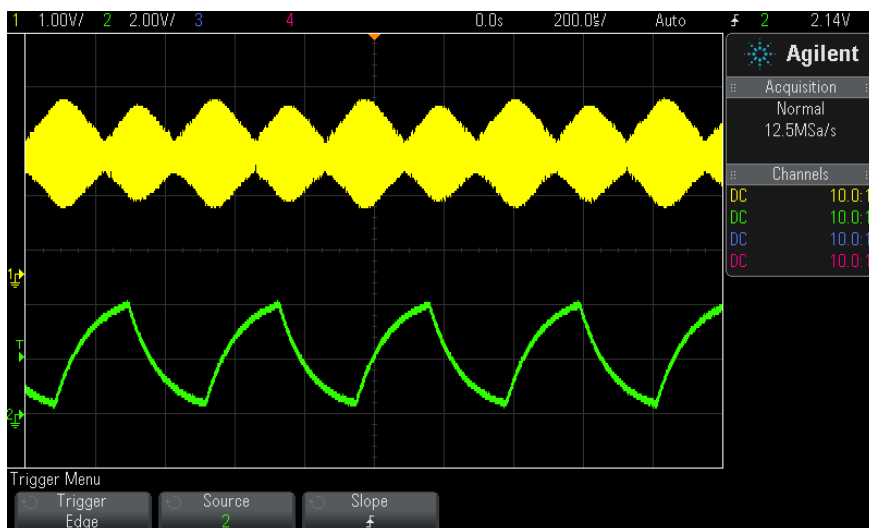

Figure 25 Amplitude Modulation Shown at 100% Intensity

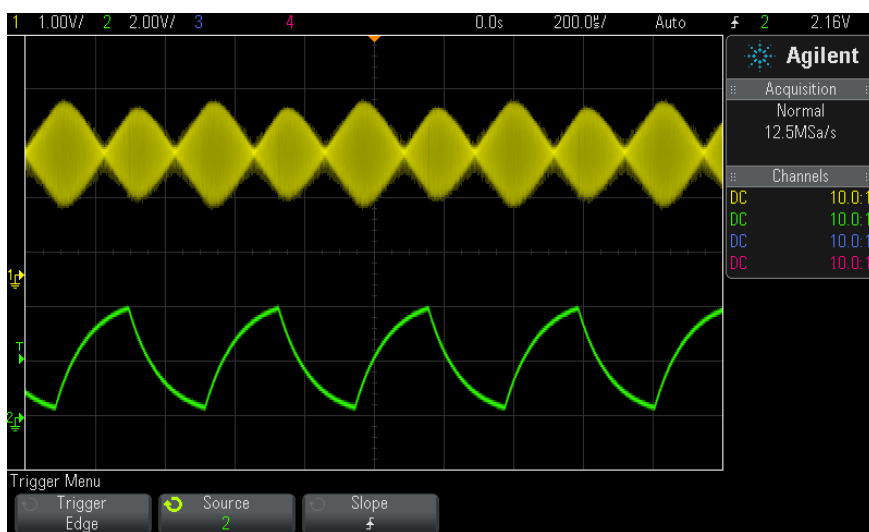

Figure 26 Amplitude Modulation Shown at 40% Intensity

To set or clear persistence

With persistence, the oscilloscope updates the display with new acquisitions, but does not immediately erase the results of previous acquisitions. All previous acquisitions are displayed with reduced intensity. New acquisitions are shown in their normal color with normal intensity.

Waveform persistence is kept only for the current display area; you cannot pan and zoom the persistence display.

To use persistence:

- 1 Press the **[Display]** key.



- 2 Press **Persistence**; then, turn the Entry knob to select between:

- **Off** – turns off persistence.

When persistence is off, you can press the **Capture Waveforms** softkey to perform a single-shot infinite persistence. A single acquisition's data is displayed with reduced intensity, and it remains on the display until you clear persistence or clear the display.

- ∞ Persistence – (infinite persistence) Results of previous acquisitions are never erased.

Use infinite persistence to measure noise and jitter, to see the worst-case extremes of varying waveforms, to look for timing violations, or to capture events that occur infrequently.

- **Variable Persistence** – Results of previous acquisitions are erased after a certain amount of time.

Variable persistence gives you a view of acquired data that is similar to analog oscilloscopes.

When variable persistence is selected, press the **Time** softkey and use the Entry knob to specify the amount of time that previous acquisitions are to be displayed.

The display will begin accumulating multiple acquisitions.

- 3 To erase the results of previous acquisitions from the display, press the **Clear Persistence** softkey.

The oscilloscope will start to accumulate acquisitions again.

- 4 To return the oscilloscope to the normal display mode, turn off persistence; then, press the **Clear Persistence** softkey.

Turning off persistence does not clear the display. The display is cleared if you press the **Clear Display** softkey or if you press the **[AutoScale]** key (which also turns off persistence).

For another method of seeing worst-case extremes of varying waveforms, see ["Glitch or Narrow Pulse Capture"](#) on page 195.

To clear the display

- 1 Press **[Display] > Clear Display**.

You can also configure the **[Quick Action]** key to clear the display. See ["Configuring the \[Quick Action\] Key"](#) on page 311.

To select the grid type

When the **Video** trigger type is selected (see ["Video Trigger"](#) on page 163), and the vertical scaling of at least one displayed channel is 140 mV/div, the **Grid** softkey lets you select from these grid types:

- **Full** – the normal oscilloscope grid.
- **mV** – shows vertical grids, labeled on the left, from -0.3 V to 0.8 V.
- **IRE** – (Institute of Radio Engineers) shows vertical grids in IRE units, labeled on the left, from -40 to 100 IRE. The 0.35 V and 0.7 V levels from the **mV** grid are also shown and labeled at the right. When the **IRE** grid is selected, cursor values are also shown in IRE units. (Cursor values via the remote interface are not in IRE units.)

The **mV** and **IRE** grid values are accurate (and match Y cursor values) when the vertical scaling is 140 mV/division and the vertical offset is 245 mV.

To select the grid type:

- 1 Press **[Display]**.
- 2 Press the **Grid** softkey; then, turn the Entry knob  to select the grid type.

To adjust the grid intensity

To adjust the display grid (graticule) intensity:

- 1 Press **[Display]**.
- 2 Press the **Intensity** softkey; then, turn the Entry knob  to change the intensity of the displayed grid.

The intensity level is shown in the **Intensity** softkey and is adjustable from 0 to 100%.

Each major vertical division in the grid corresponds to the vertical sensitivity shown in the status line at the top of the display.

Each major horizontal division in the grid corresponds to the time/div shown in the status line at the top of the display.

To freeze the display

To freeze the display without stopping running acquisitions, you must configure the **[Quick Action]** key. See "[Configuring the \[Quick Action\] Key](#)" on page 311.

- 1 Once the **[Quick Action]** key has been configured, press it to freeze the display.
- 2 To un-freeze the display, press **[Quick Action]** again.

Manual cursors can be used on the frozen display.

Many activities, such as adjusting the trigger level, adjusting vertical or horizontal settings, or saving data will un-freeze the display.



9 Labels

- To turn the label display on or off [137](#)
- To assign a predefined label to a channel [138](#)
- To define a new label [139](#)
- To load a list of labels from a text file you create [140](#)
- To reset the label library to the factory default [141](#)

You can define labels and assign them to each analog input channel, or you can turn labels off to increase the waveform display area. Labels can also be applied to digital channels on MSO models.

To turn the label display on or off

- 1 Press the **[Label]** key on the front panel.

This turns on labels for the displayed analog and digital channels. Labels are displayed at the left edge of the displayed traces.

The figure below shows an example of displayed labels.



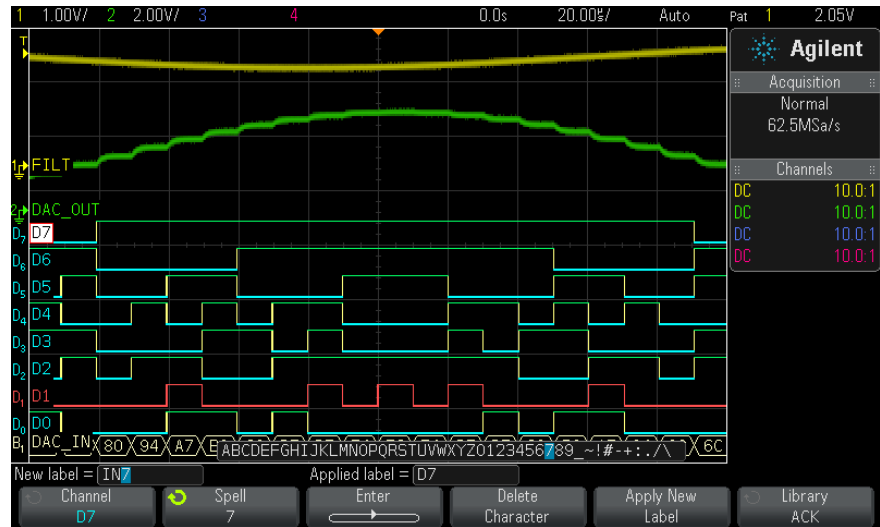

- 2 To turn the labels off, press the [Label] key again.

To assign a predefined label to a channel

- 1 Press the [Label] key.
- 2 Press the **Channel** softkey, then turn the Entry knob or successively press the **Channel** softkey to select a channel for label assignment.

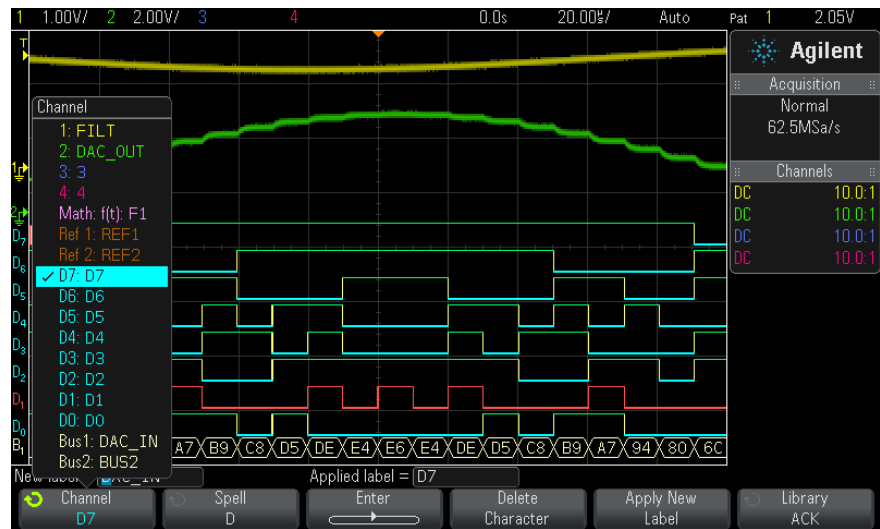

The figure above shows the list of channels and their default labels. The channel does not have to be turned on to have a label assigned to it.

- 3 Press the **Library** softkey, then turn the Entry knob or successively press the **Library** softkey to select a predefined label from the library.
- 4 Press the **Apply New Label** softkey to assign the label to your selected channel.
- 5 Repeat the above procedure for each predefined label you want to assign to a channel.

To define a new label

- 1 Press the **[Label]** key.
- 2 Press the **Channel** softkey; then, turn the Entry knob or successively press the softkey to select a channel for label assignment.

The channel does not have to be turned on to have a label assigned to it. If the channel is turned on, its current label will be highlighted.

- 3 Press the **Spell** softkey; then, turn the Entry knob to select the first character in the new label.

Turning the Entry knob selects a character to enter into the highlighted position shown in the "New label =" line above the softkeys and in the **Spell** softkey. Labels can be up to ten characters in length.

- 4 Press the **Enter** softkey to enter the selected character and to go to the next character position.
- 5 You may position the highlight on any character in the label name by successively pressing the **Enter** softkey.
- 6 To delete a character from the label, press the **Enter** softkey until the letter you want to delete is highlighted, then press the **Delete Character** softkey.

NOTE

You can use a connected USB keyboard instead of using the **Spell** (and other) character editing softkeys.

- 7 When you are done entering characters for the label, press the **Apply New Label** softkey to assign the label to the selected channel.

When you define a new label, it is added to the nonvolatile label list.

Label Assignment Auto-Increment

When you assign a label ending in a digit, such as ADDR0 or DATA0, the oscilloscope automatically increments the digit and displays the modified label in the "New label" field after you press the **Apply New Label** softkey. Therefore, you only need to select a new channel and press the **Apply New Label** softkey again to assign the label to the channel. Only the original label is saved in the label list. This feature makes it easier to assign successive labels to numbered control lines and data bus lines.

To load a list of labels from a text file you create

It may be convenient to create a list of labels using a text editor, then load the label list into the oscilloscope. This lets you type on a keyboard rather than edit the label list using the oscilloscope's controls.

You can create a list of up to 75 labels and load it into the oscilloscope. Labels are added to the beginning of the list. If more than 75 labels are loaded, only the first 75 are stored.

To load labels from a text file into the oscilloscope:

- 1 Use a text editor to create each label. Each label can be up to ten characters in length. Separate each label with a line feed.
- 2 Name the file `labellist.txt` and save it on a USB mass storage device such as a thumb drive.
- 3 Load the list into the oscilloscope using the File Explorer (press **[Utility]** > **File Explorer**).

NOTE**Label List Management**

When you press the **Library** softkey, you will see a list of the last 75 labels used. The list does not save duplicate labels. Labels can end in any number of trailing digits. As long as the base string is the same as an existing label in the library, the new label will not be put in the library. For example, if label A0 is in the library and you make a new label called A12345, the new label is not added to the library.

When you save a new user-defined label, the new label will replace the oldest label in the list. Oldest is defined as the longest time since the label was last assigned to a channel. Any time you assign any label to a channel, that label will move to the newest in the list. Thus, after you use the label list for a while, your labels will predominate, making it easier to customize the instrument display for your needs.

When you reset the label library list (see next topic), all of your custom labels will be deleted, and the label list will be returned to its factory configuration.

To reset the label library to the factory default

NOTE

Pressing the Default Library softkey will remove all user-defined labels from the library and set the labels back to the factory default. Once deleted, these user-defined labels cannot be recovered.

- 1 Press **[Utility]** > **Options** > **Preferences**.
- 2 Press the **Default Library** softkey.

This will delete all user-defined labels from the library and set the labels in the library back to the factory default. However, this does not default the labels currently assigned to the channels (those labels that appear in the waveform area).

NOTE

Defaulting labels without erasing the default library

Pressing [**Default Setup**] sets all channel labels back to the default labels but does not erase the list of user-defined labels in the library.



10 Triggers

Adjusting the Trigger Level	145
Forcing a Trigger	145
Edge Trigger	146
Edge then Edge Trigger	148
Pulse Width Trigger	149
Pattern Trigger	152
OR Trigger	155
Rise/Fall Time Trigger	157
Nth Edge Burst Trigger	158
Runt Trigger	160
Setup and Hold Trigger	162
Video Trigger	163
USB Trigger	175
Serial Trigger	177

A trigger setup tells the oscilloscope when to acquire and display data. For example, you can set up to trigger on the rising edge of the analog channel 1 input signal.

You can adjust the vertical level used for analog channel edge detection by turning the Trigger Level knob.

In addition to the edge trigger type, you can also set up triggers on rise/fall times, Nth edge bursts, patterns, pulse widths, runt pulses, setup and hold violations, TV signals, USB signals, and serial signals (if option licenses are installed).

You can use any input channel or the "[External Trigger Input](#)" on page 184 BNC as the source for most trigger types.



Changes to the trigger setup are applied immediately. If the oscilloscope is stopped when you change a trigger setup, the oscilloscope uses the new specification when you press **[Run/Stop]** or **[Single]**. If the oscilloscope is running when you change a trigger setup, it uses the new trigger definition when it starts the next acquisition.

You can use the **[Force Trigger]** key to acquire and display data when triggers are not occurring.

You can use the **[Mode/Coupling]** key to set options that affect all trigger types (see [Chapter 11](#), “Trigger Mode/Coupling,” starting on page 179).

You can save trigger setups along with the oscilloscope setup (see [Chapter 18](#), “Save/Recall (Setups, Screens, Data),” starting on page 273).

Triggers - General Information

A triggered waveform is one in which the oscilloscope begins tracing (displaying) the waveform, from the left side of the display to the right, each time a particular trigger condition is met. This provides stable display of periodic signals such as sine waves and square waves, as well as nonperiodic signals such as serial data streams.

The figure below shows the conceptual representation of acquisition memory. You can think of the trigger event as dividing acquisition memory into a pre-trigger and post-trigger buffer. The position of the trigger event in acquisition memory is defined by the time reference point and the delay (horizontal position) setting (see ["To adjust the horizontal delay \(position\)"](#) on page 51).

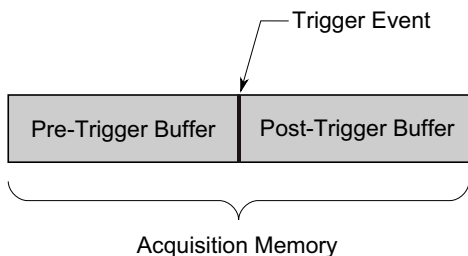

Adjusting the Trigger Level

You can adjust the trigger level for a selected analog channel by turning the Trigger Level knob.

You can push the Trigger Level knob to set the level to the waveform's 50% value. If AC coupling is used, pushing the Trigger Level knob sets the trigger level to about 0 V.

The position of the trigger level for the analog channel is indicated by the trigger level icon \uparrow (if the analog channel is on) at the far left side of the display. The value of the analog channel trigger level is displayed in the upper-right corner of the display.

The trigger level for a selected digital channel is set using the threshold menu in the Digital Channel Menu. Press the **[Digital]** key on the front panel, then press the **Thresholds** softkey to set the threshold level (TTL, CMOS, ECL, or user defined) for the selected digital channel group. The threshold value is displayed in the upper-right corner of the display.

The line trigger level is not adjustable. This trigger is synchronized with the power line supplied to the oscilloscope.

NOTE

You can also change the trigger level of all channels by pressing **[Analyze] > Features** and then selecting **Trigger Levels**.

Forcing a Trigger

The **[Force Trigger]** key causes a trigger (on anything) and displays the acquisition.

This key is useful in the Normal trigger mode where acquisitions are made only when the trigger condition is met. In this mode, if no triggers are occurring (that is, the "Trig'd?" indicator is displayed), you can press **[Force Trigger]** to force a trigger and see what the input signals look like.

In the Auto trigger mode, when the trigger condition is not met, triggers are forced and the "Auto?" indicator is displayed.

Edge Trigger

The Edge trigger type identifies a trigger by looking for a specified edge (slope) and voltage level on a waveform. You can define the trigger source and slope in this menu. The trigger type, source, and level are displayed in the upper-right corner of the display.

- 1 On the front panel, in the Trigger section, press the **[Trigger]** key.
- 2 In the Trigger Menu, press the **Trigger** softkey, and use the Entry knob to select **Edge**.
- 3 Select the trigger source:
 - Analog channel, **1** to the number of channels
 - Digital channel (on mixed-signal oscilloscopes), **D0** to the number of digital channels minus one.
 - **External** – triggers on the rear panel EXT TRIG IN signal.
 - **Line** – triggers at the 50% level of the rising or falling edge of the AC power source signal.
 - **WaveGen** – triggers at the 50% level of the rising edge of the waveform generator output signal. (Not available when the DC, Noise, or Cardiac waveforms are selected.)

You can choose a channel that is turned off (not displayed) as the source for the edge trigger.

The selected trigger source is indicated in the upper-right corner of the display next to the slope symbol:

- **1** through **4** = analog channels.
 - **D0** through **Dn** = digital channels.
 - **E** = External trigger input.
 - **L** = Line trigger.
 - **W** = Waveform generator.
- 4 Press the **Slope** softkey and select rising edge, falling edge, alternating edges, or either edge (depending on the selected source). The selected slope is displayed in the upper-right corner of the display.

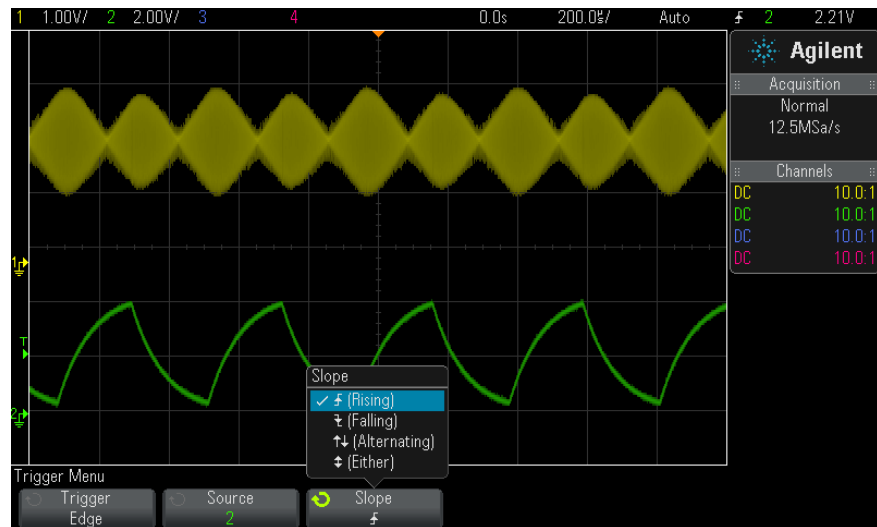
**NOTE**

Alternating edge mode is useful when you want to trigger on both edges of a clock (for example, DDR signals).

Either edge mode is useful when you want to trigger on any activity of a selected source.

All modes operate up to the bandwidth of the oscilloscope except Either edge mode, which has a limitation. Either edge mode will trigger on Constant Wave signals up to 100 MHz, but can trigger on isolated pulses down to $1/(2 * \text{oscilloscope's bandwidth})$.

Using AutoScale to Set Up Edge Triggers

The easiest way to set up an Edge trigger on a waveform is to use AutoScale. Simply press the [**AutoScale**] key and the oscilloscope will attempt to trigger on the waveform using a simple Edge trigger type. See "[Use Auto Scale](#)" on page 32.

NOTE**MegaZoom Technology Simplifies Triggering**

With the built-in MegaZoom technology, you can simply AutoScale the waveforms, then stop the oscilloscope to capture a waveform. You can then pan and zoom through the data using the Horizontal and Vertical knobs to find a stable trigger point. AutoScale often produces a triggered display.

Edge then Edge Trigger

The Edge then Edge trigger mode triggers when the Nth edge occurs after an arming edge and a delay period.

The arm and trigger edges can be specified as \uparrow (Rising) or \downarrow (Falling) edges on analog or digital channels.

- 1 Press the **[Trigger]** key.
- 2 In the Trigger Menu, press the **Trigger** softkey; then, turn the Entry knob to select **Edge then Edge**.

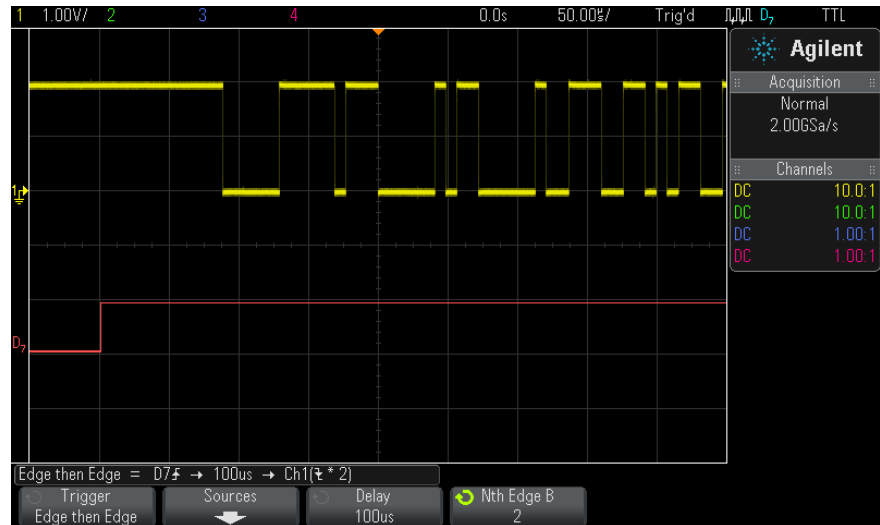

- 3 Press the **Sources** softkey.
- 4 In the Edge then edge Sources Menu:



- a Press the **Arm A** softkey, and turn the Entry knob to select the channel on which the arming edge will occur.
- b Press the **Slope A** softkey to specify which edge of the Arm A signal will arm the oscilloscope.
- c Press the **Trigger B** softkey, and turn the Entry knob to select the channel on which the trigger edge will occur.
- d Press the **Slope B** softkey to specify which edge of the Trigger B signal will trigger the oscilloscope.

Adjust the trigger level for the selected analog channel by turning the Trigger Level knob. Press the **[Digital]** key and select **Thresholds** to set the threshold level for digital channels. The value of the trigger level or digital threshold is displayed in the upper-right corner of the display.

- 5 Press the  Back/Up key to return to the Trigger Menu.
- 6 Press the **Delay** softkey; then, turn the Entry knob to enter the delay time between the Arm A edge and the Trigger B edge.
- 7 Press the **Nth Edge B** softkey; then, turn the Entry knob to select the Nth edge of the Trigger B signal to trigger on.

Pulse Width Trigger

Pulse Width (glitch) triggering sets the oscilloscope to trigger on a positive or negative pulse of a specified width. If you want to trigger on a specific timeout value, use **Pattern** trigger in the Trigger Menu (see "[Pattern Trigger](#)" on page 152).

- 1 Press the **[Trigger]** key.
- 2 In the Trigger Menu, press the **Trigger** softkey; then, turn the Entry knob to select **Pulse Width**.

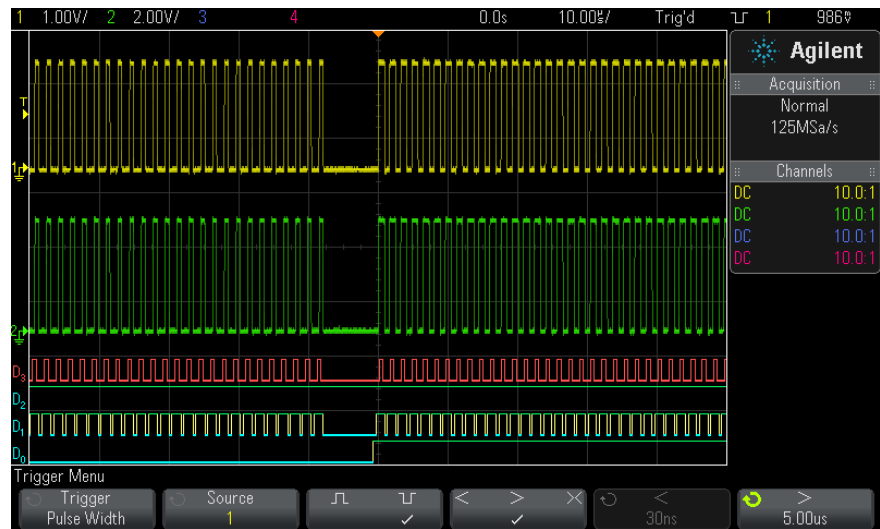

- 3 Press the **Source** softkey; then, rotate the Entry knob to select a channel source for the trigger.

The channel you select is shown in the upper-right corner of the display next to the polarity symbol.

The source can be any analog or digital channel available on your oscilloscope.

- 4 Adjust the trigger level:
 - For analog channels, turn the Trigger Level knob.
 - For digital channels, press the **[Digital]** key and select **Thresholds** to set the threshold level.

The value of the trigger level or digital threshold is displayed in the upper-right corner of the display.

- 5 Press the pulse polarity softkey to select positive (\lceil) or negative (\lfloor) polarity for the pulse width you want to capture.

The selected pulse polarity is displayed in the upper-right corner of the display. A positive pulse is higher than the current trigger level or threshold and a negative pulse is lower than the current trigger level or threshold.

When triggering on a positive pulse, the trigger will occur on the high to low transition of the pulse if the qualifying condition is true. When triggering on a negative pulse, the trigger will occur on the low to high transition of the pulse if the qualifying condition is true.

6 Press the qualifier softkey (< > ><) to select the time qualifier.

The Qualifier softkey can set the oscilloscope to trigger on a pulse width that is:

- Less than a time value (<).

For example, for a positive pulse, if you set $t < 10$ ns:

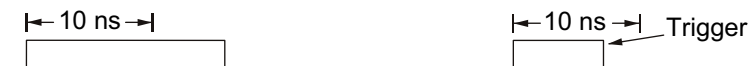

- Greater than a time value (>).

For example, for a positive pulse, if you set $t > 10$ ns:



- Within a range of time values (><).

For example, for a positive pulse, if you set $t > 10$ ns and $t < 15$ ns:

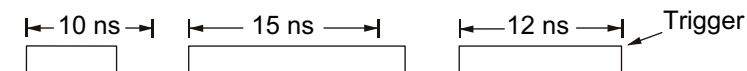

7 Select the qualifier time set softkey (< or >), then rotate the Entry knob to set the pulse width qualifier time.

The qualifiers can be set as follows:

- 2 ns to 10 s for > or < qualifier (5 ns to 10 s for 350 MHz bandwidth models).
- 10 ns to 10 s for >< qualifier, with minimum difference of 5 ns between upper and lower settings.

10 Triggers

Pulse width trigger < qualifier time set softkey

- When the less than (<) qualifier is selected, the Entry knob sets the oscilloscope to trigger on a pulse width less than the time value displayed on the softkey.
- When the time range (><) qualifier is selected, the Entry knob sets the upper time range value.

Pulse width trigger > qualifier time set softkey

- When the greater than (>) qualifier is selected, the Entry knob sets the oscilloscope to trigger on a pulse width greater than the time value displayed on the softkey.
- When the time range (><) qualifier is selected, the Entry knob sets the lower time range value.

Pattern Trigger

The Pattern trigger identifies a trigger condition by looking for a specified pattern. This pattern is a logical AND combination of the channels. Each channel can have a value of 0 (low), 1 (high), or don't care (X). A rising or falling edge can be specified for one channel included in the pattern. You can also trigger on a hex bus value as described on "[Hex Bus Pattern Trigger](#)" on page 155.

- 1 Press the **[Trigger]** key.
- 2 In the Trigger Menu, press the **Trigger** softkey; then, turn the Entry knob to select **Pattern**.
- 3 Press the **Qualifier** softkey; then, turn the Entry knob to select from the pattern duration qualifier options:
 - **Entered** – when the pattern is entered.
 - **< (Less Than)** – when the pattern is present for less than a time value.
 - **> (Greater Than)** – when the pattern is present for greater than a time value. The trigger occurs when the pattern exits (not when the > softkey time value is exceeded).
 - **Timeout** – when the pattern is present for greater than a time value. In this case, the trigger occurs when the > softkey time value is exceeded (not when the pattern exits).
 - **>< (In Range)** – when the pattern is present for a time within a range of values.

- **<> (Out of Range)** – when the pattern is present for a time outside of range of values.

Pattern durations are evaluated using a timer. The timer starts on the last edge that makes the pattern (logical AND) true. Except when the **Timeout** qualifier is selected, the trigger occurs on the first edge that makes the pattern false, provided the time qualifier criteria has been met.

The time values for the selected qualifier are set using the qualifier time set softkeys (< and >) and the Entry knob.

- 4 For each analog or digital channel you want to include in the desired pattern, press the **Channel** softkey to select the channel.

This is the channel source for the 0, 1, X, or edge condition. As you press the **Channel** softkey (or rotate the Entry knob), the channel you select is highlighted in the Pattern = line directly above the softkeys and in the upper-right corner of the display next to "Pat".

Adjust the trigger level for the selected analog channel by turning the Trigger Level knob. Press the **[Digital]** key and select **Thresholds** to set the threshold level for digital channels. The value of the trigger level or digital threshold is displayed in the upper-right corner of the display.

- 5 For each channel you select, press the **Pattern** softkey; then, turn the Entry knob to set the condition for that channel in the pattern.

10 Triggers

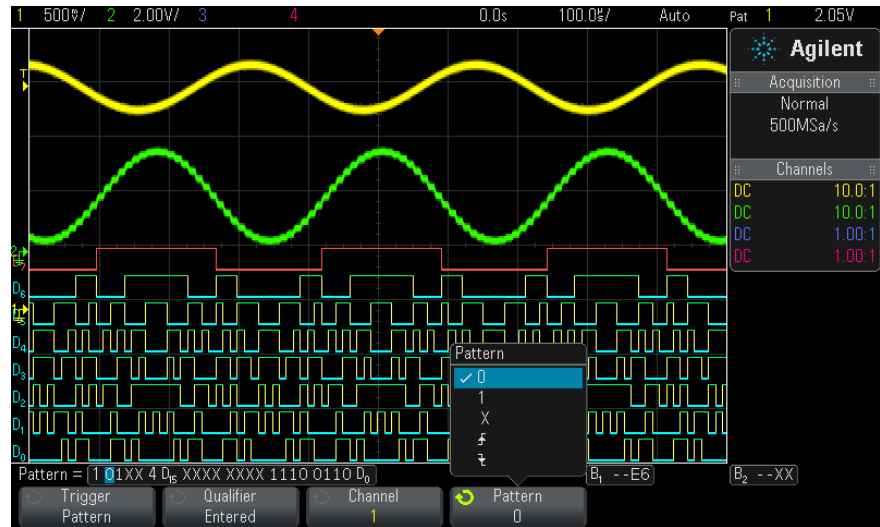

- **0** sets the pattern to zero (low) on the selected channel. A low is a voltage level that is less than the channel's trigger level or threshold level.
- **1** sets the pattern to 1 (high) on the selected channel. A high is a voltage level that is greater than the channel's trigger level or threshold level.
- **X** sets the pattern to don't care on the selected channel. Any channel set to don't care is ignored and is not used as part of the pattern. However, if all channels in the pattern are set to don't care, the oscilloscope will not trigger.
- The rising edge (\uparrow) or falling edge (\downarrow) softkey sets the pattern to an edge on the selected channel. Only one rising or falling edge can be specified in the pattern. When an edge is specified, the oscilloscope will trigger at the edge specified if the pattern set for the other channels is true.

If no edge is specified, the oscilloscope will trigger on the last edge that makes the pattern true.

NOTE**Specifying an Edge in a Pattern**

You are allowed to specify only one rising or falling edge term in the pattern. If you define an edge term, then select a different channel in the pattern and define another edge term, the previous edge definition is changed to a don't care.

Hex Bus Pattern Trigger

You can specify a bus value on which to trigger. To do this, first define the bus. See ["To display digital channels as a bus"](#) on page 114 for details. You can trigger on a bus value whether you are displaying the bus or not.

To trigger on a bus value:

- 1 Press the **[Pattern]** key on the front panel.
- 2 Press the **Channel** softkey and rotate the Entry knob to select **Bus1** or **Bus2**.
- 3 Press the **Digit** softkey and rotate the Entry knob to select a digit of the selected bus.
- 4 Press the **Hex** softkey and rotate the Entry knob to select a value for the digit.

NOTE

If a digit is made up of less than four bits, then the value of the digit will be limited to the value that can be created by the selected bits.

- 5 You can use the **Set all Digits** softkey to set all digits to a particular value.

When a hex bus digit contains one or more don't care (X) bits and one or more bit with a value or 0 or 1, the "\$" sign will be displayed for the digit.

For information regarding digital bus display when Pattern triggering see ["Bus values are displayed when using Pattern trigger"](#) on page 116.

OR Trigger

The OR trigger mode triggers when any one (or more) of the specified edges on analog or digital channels is found.

10 Triggers

- 1 On the front panel, in the Trigger section, press the **[Trigger]** key.
- 2 In the Trigger Menu, press the **Trigger** softkey, and use the Entry knob to select **OR**.
- 3 Press the **Slope** softkey and select rising edge, falling edge, either edge, or don't care. The selected slope is displayed in the upper-right corner of the display.
- 4 For each analog or digital channel you want to include in the OR trigger, press the **Channel** softkey to select the channel.

As you press the **Channel** softkey (or rotate the Entry knob), the channel you select is highlighted in the OR = line directly above the softkeys and in the upper-right corner of the display next to the OR gate symbol.

Adjust the trigger level for the selected analog channel by turning the Trigger Level knob. Press the **[Digital]** key and select **Thresholds** to set the threshold level for digital channels. The value of the trigger level or digital threshold is displayed in the upper-right corner of the display.

- 5 For each channel you select, press the **Slope** softkey and select \uparrow (Rising), \downarrow (Falling), \updownarrow (Either), or X (Don't Care). The selected slope is displayed above the softkeys.

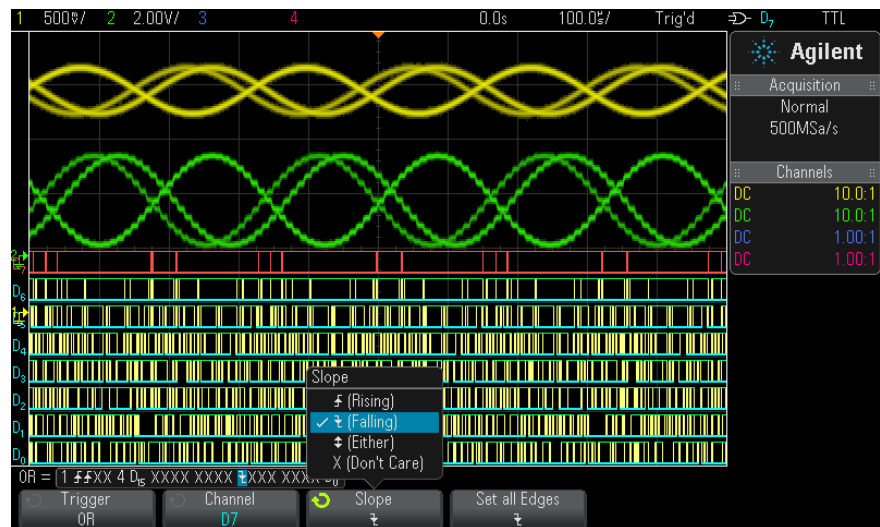

If all channels in the OR trigger are set to don't care, the oscilloscope will not trigger.

- 6 To set all analog and digital channels to the edge selected by the **Slope** softkey, press the **Set all Edges** softkey.

Rise/Fall Time Trigger

The Rise/Fall Time trigger looks for a rising or falling transition from one level to another level in greater than or less than a certain amount of time.

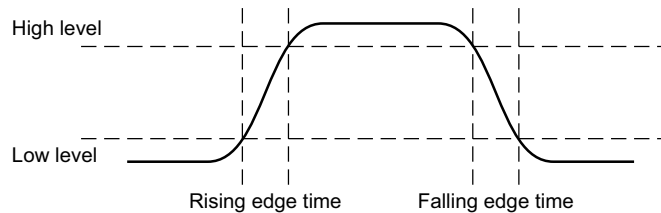

- 1 Press the **[Trigger]** key.
- 2 In the Trigger Menu, press the **Trigger** softkey; then, turn the Entry knob to select **Rise/Fall Time**.

10 Triggers

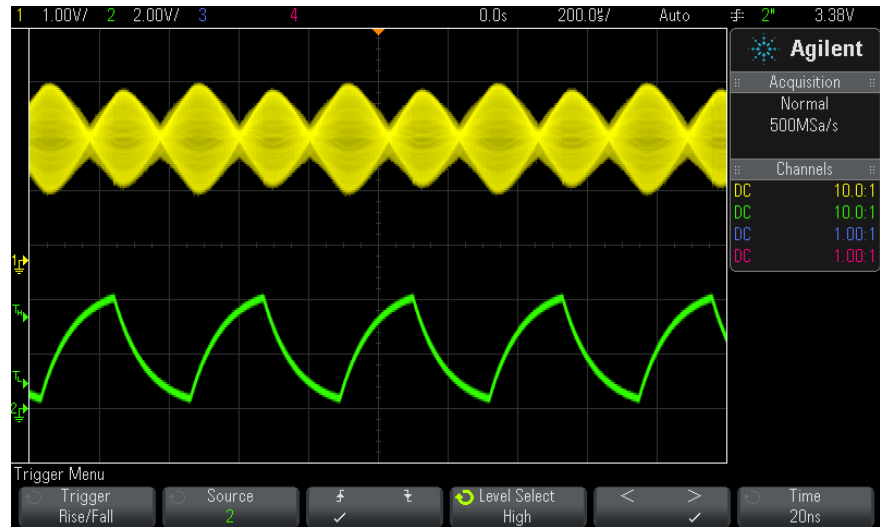

- 3 Press the **Source** softkey, and turn the Entry knob to select the input channel source.
- 4 Press the **Rising Edge or Falling Edge** softkey to toggle between edge types.
- 5 Press the **Level Select** softkey to select **High**; then, turn the Trigger Level knob to adjust the high level.
- 6 Press the **Level Select** softkey to select **Low**; then, turn the Trigger Level knob to adjust the low level.

You can also push the Trigger Level knob to toggle between **High** and **Low** selection.

- 7 Press the **Qualifier** softkey to toggle between "greater than" or "less than".
- 8 Press the **Time** softkey, and turn the Entry knob to select the time.

Nth Edge Burst Trigger

The Nth Edge Burst trigger lets you trigger on the Nth edge of a burst that occurs after an idle time.

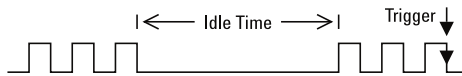

Nth Edge Burst trigger set up consists of selecting the source, the slope of the edge, the idle time, and the number of the edge:

- 1 Press the **[Trigger]** key.
- 2 In the Trigger Menu, press the **Trigger** softkey; then, turn the Entry knob to select **Nth Edge Burst**.

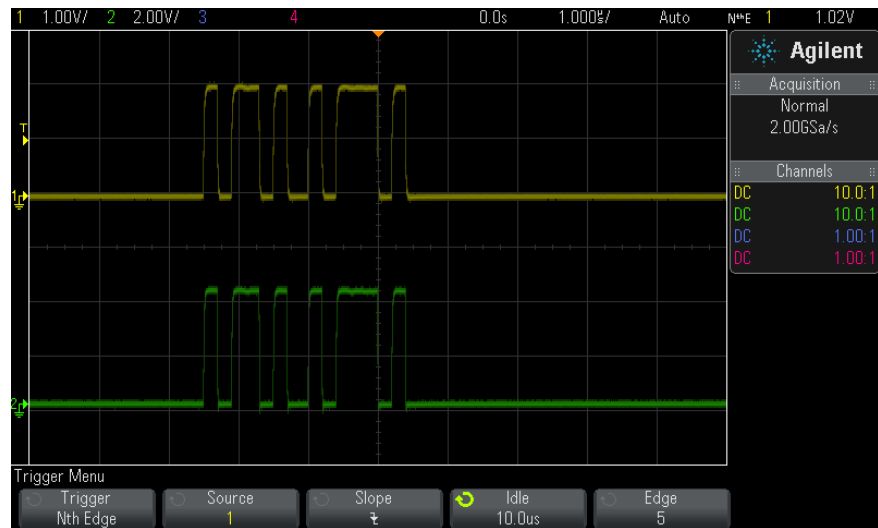

- 3 Press the **Source** softkey, and turn the Entry knob to select the input channel source.
- 4 Press the **Slope** softkey to specify the slope of the edge.
- 5 Press the **Idle** softkey; then, turn the Entry knob to specify the idle time.
- 6 Press the **Edge** softkey; then, turn the Entry knob to which edge number to trigger on.

Runt Trigger

The Runt trigger looks for pulses that cross one threshold but not another.

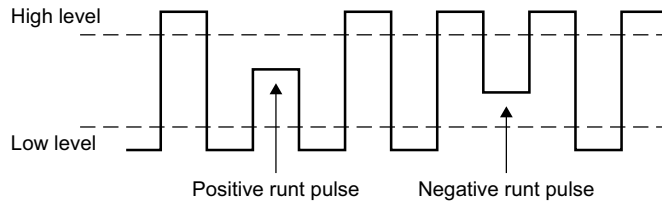

- A positive runt pulse crosses through a lower threshold but not an upper threshold.
- A negative runt pulse crosses through an upper threshold but not a lower threshold.

To trigger on runt pulses:

- 1 Press the **[Trigger]** key.
- 2 In the Trigger Menu, press the **Trigger** softkey; then, turn the Entry knob to select **Runt**.



- 3 Press the **Source** softkey, and turn the Entry knob to select the input channel source.
- 4 Press the **Positive, Negative, or Either Runt Pulse** softkey to toggle between pulse types.
- 5 Press the **Level Select** softkey to select **High**; then, turn the Trigger Level knob to adjust the high level.
- 6 Press the **Level Select** softkey to select **Low**; then, turn the Trigger Level knob to adjust the low level.

You can also push the Trigger Level knob to toggle between **High** and **Low** selection.

- 7 Press the **Qualifier** softkey to toggle between "less than", "greater than", or **None**.

This lets you specify that a runt pulse be less than or greater than a certain width.

- 8 If you selected the "less than" or "greater than" **Qualifier**, press the **Time** softkey; then, turn the Entry knob to select the time.

Setup and Hold Trigger

The Setup and Hold trigger looks for setup and hold violations.

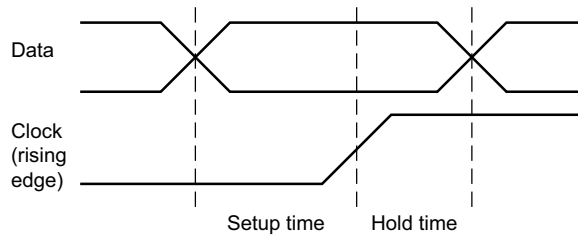

One oscilloscope channel probes the clock signal and another channel probes the data signal.

To trigger on setup & hold violations:

- 1 Press the **[Trigger]** key.
- 2 In the Trigger Menu, press the **Trigger** softkey; then, turn the Entry knob to select **Setup and Hold**.
- 3 Press the **Clock** softkey; then, turn the Entry knob to select the input channel with the clock signal.
- 4 Set the appropriate trigger level for the clock signal using the Trigger Level knob.
- 5 Press the **Rising Edge or Falling Edge** softkey to specify the clock edge being used.
- 6 Press the **Data** softkey; then, turn the Entry knob to select the input channel with the data signal.
- 7 Set the appropriate trigger level for the data signal using the Trigger Level knob.
- 8 Press the **< Setup** softkey, and turn the Entry knob to select the setup time.

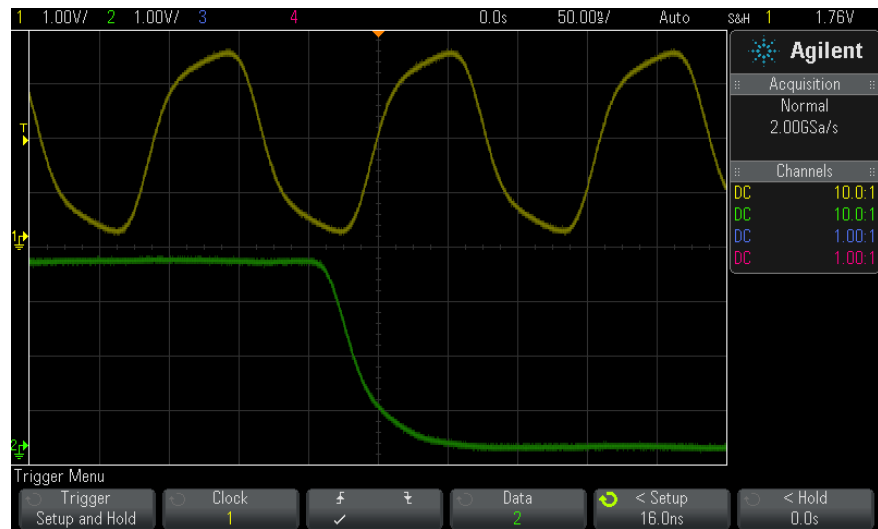

- 9 Press the **< Hold** softkey, and turn the Entry knob to select the hold time.

Video Trigger

Video triggering can be used to capture the complicated waveforms of most standard analog video signals. The trigger circuitry detects the vertical and horizontal interval of the waveform and produces triggers based on the video trigger settings you have selected.

The oscilloscope's MegaZoom IV technology gives you bright, easily viewed displays of any part of the video waveform. Analysis of video waveforms is simplified by the oscilloscope's ability to trigger on any selected line of the video signal.

NOTE

It is important, when using a 10:1 passive probe, that the probe is correctly compensated. The oscilloscope is sensitive to this and will not trigger if the probe is not properly compensated, especially for progressive formats.

- 1 Press the **[Trigger]** key.

10 Triggers

- 2 In the Trigger Menu, press the **Trigger** softkey; then, turn the Entry knob to select **Video**.

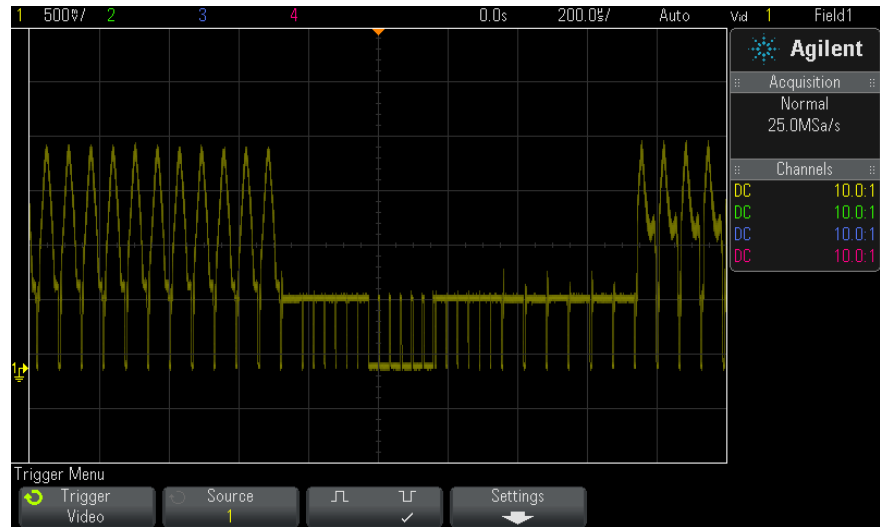

- 3 Press the **Source** softkey and select any analog channel as the video trigger source.

The selected trigger source is displayed in the upper-right corner of the display. Turning the Trigger **Level** knob does not change the trigger level because the trigger level is automatically set to the sync pulse. Trigger coupling is automatically set to **TV** in the Trigger Mode and Coupling Menu.

NOTE

Provide Correct Matching

Many video signals are produced from 75 Ω sources. To provide correct matching to these sources, a 75 Ω terminator (such as an Agilent 11094B) should be connected to the oscilloscope input.

- 4 Press the sync polarity softkey to set the Video trigger to either positive (\square) or negative (\sqcup) sync polarity.
- 5 Press the **Settings** softkey.



- 6 In the Video Trigger Menu, press the **Standard** softkey to set the video standard.

The oscilloscope supports triggering on the following television (TV) and video standards.

Standard	Type	Sync Pulse
NTSC	Interlaced	Bi-level
PAL	Interlaced	Bi-level
PAL-M	Interlaced	Bi-level
SECAM	Interlaced	Bi-level

With the DSOX3VID extended video triggering license, the oscilloscope additionally supports these standards:

Standard	Type	Sync Pulse
Generic	Interlaced/Progressive	Bi-level/Tri-level
EDTV 480p/60	Progressive	Bi-level
EDTV 567p/50	Progressive	Bi-level
HDTV 720p/50	Progressive	Tri-level
HDTV 720p/60	Progressive	Tri-level
HDTV 1080p/24	Progressive	Tri-level
HDTV 1080p/25	Progressive	Tri-level
HDTV 1080p/30	Progressive	Tri-level
HDTV 1080p/50	Progressive	Tri-level
HDTV 1080p/60	Progressive	Tri-level
HDTV 1080i/50	Interlaced	Tri-level
HDTV 1080i/60	Interlaced	Tri-level

The **Generic** selection lets you trigger on custom bi-level and tri-level sync video standards. See "[To set up Generic video triggers](#)" on page 168.

- 7 Press the **Auto Setup** softkey to automatically set up the oscilloscope for the selected **Source** and **Standard**:
 - Source channel vertical scaling is set to 140 mV/div.
 - Source channel offset is set to 245 mV.
 - Source channel is turned on.
 - Trigger type is set to **Video**.
 - Video trigger mode is set to **All Lines** (but left unchanged if **Standard** is **Generic**).
 - Display **Grid** type is set to **IRE** (when **Standard** is **NTSC**) or **mV** (see "[To select the grid type](#)" on page 134).
 - Horizontal time/division is set to 10 μ s/div for NTSC/PAL/SECAM standards or 4 μ s/div for EDTV or HDTV standards (unchanged for **Generic**).
 - Horizontal delay is set so that trigger is at first horizontal division from the left (unchanged for **Generic**).

You can also press **[Analyze]> Features** and then select **Video** to quickly access the video triggering automatic set up and display options.

- 8 Press the **Mode** softkey to select the portion of the video signal that you would like to trigger on.

The Video trigger modes available are:

- **Field1** and **Field2** – Trigger on the rising edge of the first serration pulse of field 1 or field 2 (interlaced standards only).
- **All Fields** – Trigger on the rising edge of the first pulse in the vertical sync interval.
- **All Lines** – Trigger on all horizontal sync pulses.
- **Line** – Trigger on the selected line number (EDTV and HDTV standards only).
- **Line:Field1** and **Line:Field2** – Trigger on the selected line # in field 1 or field 2 (interlaced standards only).
- **Line:Alternate** – Alternately trigger on the selected line # in field 1 and field 2 (NTSC, PAL, PAL-M, and SECAM only).

- 9 If you select a line # mode, press the **Line #** softkey, then rotate the Entry knob to select the line number on which you want to trigger.

The following table lists the line (or count) numbers per field for each video standard.

Video standard	Field 1	Field 2	Alt Field
NTSC	1 to 263	1 to 262	1 to 262
PAL	1 to 313	314 to 625	1 to 312
PAL-M	1 to 263	264 to 525	1 to 262
SECAM	1 to 313	314 to 625	1 to 312

The following table lists the line numbers for each EDTV/HDTV video standard (available with the DSOX3VID extended video triggering license).

EDTV 480p/60	1 to 525
EDTV 567p/50	1 to 625
HDTV 720p/50, 720p/60	1 to 750
HDTV 1080p/24, 1080p/25, 1080p/30, 1080p/50, 1080p/60	1 to 1125
HDTV 1080i/50, 1080i/60	1 to 1125

Video Triggering Examples

The following are exercises to familiarize you with video triggering. These exercises use the NTSC video standard.

- ["To trigger on a specific line of video"](#) on page 168
- ["To trigger on all sync pulses"](#) on page 170
- ["To trigger on a specific field of the video signal"](#) on page 170
- ["To trigger on all fields of the video signal"](#) on page 171
- ["To trigger on odd or even fields"](#) on page 172

To set up Generic video triggers

When **Generic** (available with the DSOX3VID extended video triggering license) is selected as the Video trigger **Standard**, you can trigger on custom bi-level and tri-level sync video standards. The Video Trigger Menu changes as follows.



- 1 Press the **Time >** softkey; then, turn the Entry knob to set the time to greater-than the sync-pulse width so that the oscilloscope synchronizes to the vertical sync.
- 2 Press the **Edge #** softkey; then, turn the Entry knob to select the Nth edge after after vertical sync to trigger on.
- 3 To enable or disable the horizontal sync control, press the first **Horiz Sync** softkey.
 - For interleaved video, enabling the **Horiz Sync** control and setting the **Horiz Sync** adjustment to the sync time of the probed video signal allows the **Edge #** function to count only lines and not double count during equalization. Additionally, the **Field Holdoff** can be adjusted so that the oscilloscope triggers once per frame.
 - Similarly, for progressive video with a tri-level sync, enabling the **Horiz Sync** control and setting the **Horiz Sync** adjustment to the sync time of the probed video signal allows the **Edge #** function to count only lines and not double count during vertical sync.

When the horizontal sync control is enabled, press the second **Horiz Sync** softkey; then, turn the Entry knob to set the minimum time the horizontal sync pulse must be present to be considered valid.

To trigger on a specific line of video

Video triggering requires greater than 1/2 division of sync amplitude with any analog channel as the trigger source. Turning the trigger **Level** knob in Video trigger does not change the trigger level because the trigger level is automatically set to the sync pulse tips.

One example of triggering on a specific line of video is looking at the vertical interval test signals (VITS), which are typically in line 18. Another example is closed captioning, which is typically in line 21.

- 1 Press the **[Trigger]** key.
- 2 In the Trigger Menu, press the **Trigger** softkey; then, turn the Entry knob to select **Video**.
- 3 Press the **Settings** softkey, then press the **Standard** softkey to select the appropriate TV standard (NTSC).
- 4 Press the **Mode** softkey and select the TV field of the line you want to trigger on. You can choose **Line:Field1**, **Line:Field2**, or **Line:Alternate**.
- 5 Press the **Line #** softkey and select the number of the line you want to examine.

NOTE

Alternate Triggering

If Line:Alternate is selected, the oscilloscope will alternately trigger on the selected line number in Field 1 and Field 2. This is a quick way to compare the Field 1 VITS and Field 2 VITS or to check for the correct insertion of the half line at the end of Field 1.



Figure 27 Example: Triggering on Line 136

To trigger on all sync pulses

To quickly find maximum video levels, you could trigger on all sync pulses. When **All Lines** is selected as the Video trigger mode, the oscilloscope will trigger on all horizontal sync pulses.

- 1 Press the **[Trigger]** key.
- 2 In the Trigger Menu, press the **Trigger** softkey; then, turn the Entry knob to select **Video**.
- 3 Press the **Settings** softkey, then press the **Standard** softkey to select the appropriate TV standard.
- 4 Press the **Mode** softkey and select **All Lines**.



Figure 28 Triggering on All Lines

To trigger on a specific field of the video signal

To examine the components of a video signal, trigger on either Field 1 or Field 2 (available for interleaved standards). When a specific field is selected, the oscilloscope triggers on the rising edge of the first serration pulse in the vertical sync interval in the specified field (1 or 2).

- 1 Press the **[Trigger]** key.
- 2 In the Trigger Menu, press the **Trigger** softkey; then, turn the Entry knob to select **Video**.
- 3 Press the **Settings** softkey, then press the **Standard** softkey to select the appropriate TV standard.
- 4 Press the **Mode** softkey and select **Field1** or **Field2**.

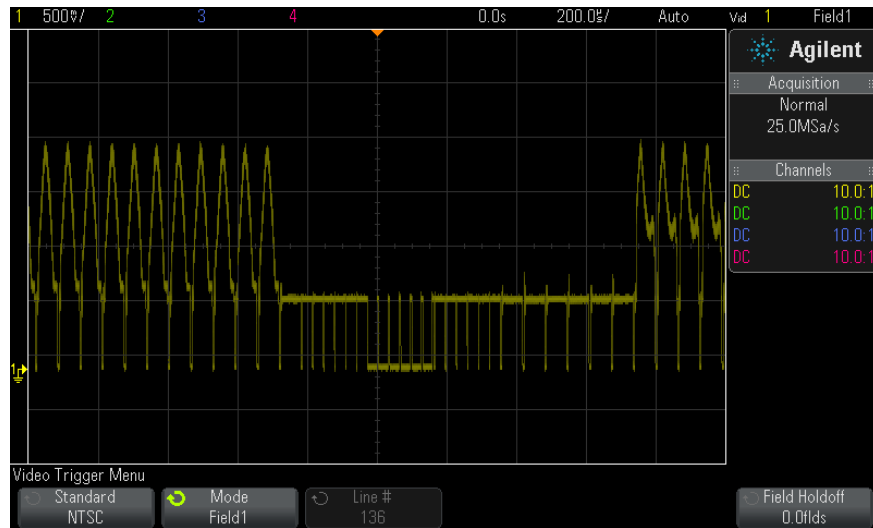

Figure 29 Triggering on Field 1

To trigger on all fields of the video signal

To quickly and easily view transitions between fields, or to find the amplitude differences between the fields, use the All Fields trigger mode.

- 1 Press the **[Trigger]** key.
- 2 In the Trigger Menu, press the **Trigger** softkey; then, turn the Entry knob to select **Video**.
- 3 Press the **Settings** softkey, then press the **Standard** softkey to select the appropriate TV standard.
- 4 Press the **Mode** softkey and select **All Fields**.

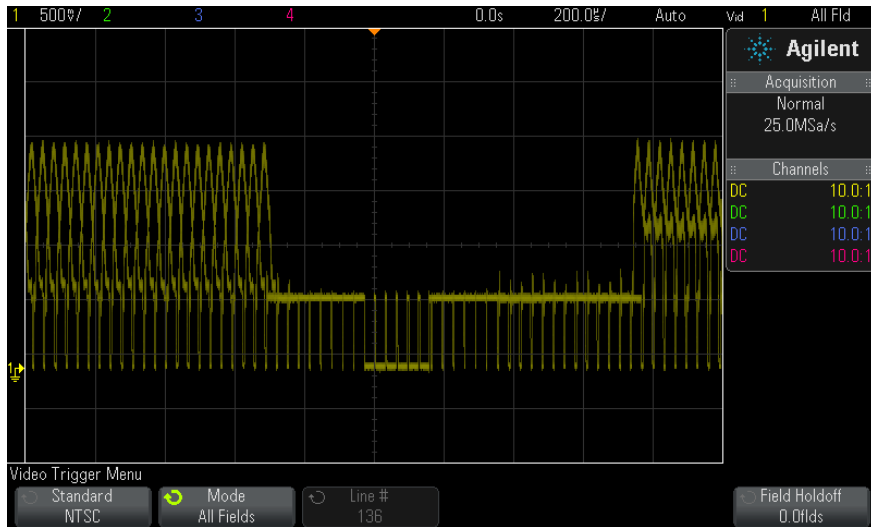

Figure 30 Triggering on All Fields

To trigger on odd or even fields

To check the envelope of your video signals, or to measure worst case distortion, trigger on the odd or even fields. When Field 1 is selected, the oscilloscope triggers on color fields 1 or 3. When Field 2 is selected, the oscilloscope triggers on color fields 2 or 4.

- 1 Press the **[Trigger]** key.
- 2 In the Trigger Menu, press the **Trigger** softkey; then, turn the Entry knob to select **Video**.
- 3 Press the **Settings** softkey, then press the **Standard** softkey to select the appropriate TV standard.
- 4 Press the **Mode** softkey and select **Field1** or **Field2**.

The trigger circuits look for the position of the start of Vertical Sync to determine the field. But this definition of field does not take into consideration the phase of the reference subcarrier. When Field 1 is selected, the trigger system will find any field where the vertical sync

starts on Line 4. In the case of NTSC video, the oscilloscope will trigger on color field 1 alternating with color field 3 (see the following figure). This setup can be used to measure the envelope of the reference burst.



Figure 31 Triggering on Color Field 1 Alternating with Color Field 3

If a more detailed analysis is required, then only one color field should be selected to be the trigger. You can do this by using the **Field Holdoff** softkey in the Video Trigger Menu. Press the **Field Holdoff** softkey and use the Entry knob to adjust the holdoff in half-field increments until the oscilloscope triggers on only one phase of the color burst.

A quick way to synchronize to the other phase is to briefly disconnect the signal and then reconnect it. Repeat until the correct phase is displayed.

When holdoff is adjusted using the **Field Holdoff** softkey and the Entry knob, the corresponding holdoff time will be displayed in the Trigger Mode and Coupling Menu.

Table 4 Half-field holdoff time

Standard	Time
NTSC	8.35 ms
PAL	10 ms
PAL-M	10 ms
SECAM	10 ms
Generic	8.35 ms
EDTV 480p/60	8.35 ms
EDTV 567p/50	10 ms
HDTV 720p/50	10 ms
HDTV 720p/60	8.35 ms
HDTV 1080p/24	20.835 ms
HDTV 1080p/25	20 ms
HDTV 1080p/30	20 ms
HDTV 1080p/50	16.67 ms
HDTV 1080p/60	8.36 ms
HDTV 1080i/50	10 ms
HDTV 1080i/60	8.35 ms

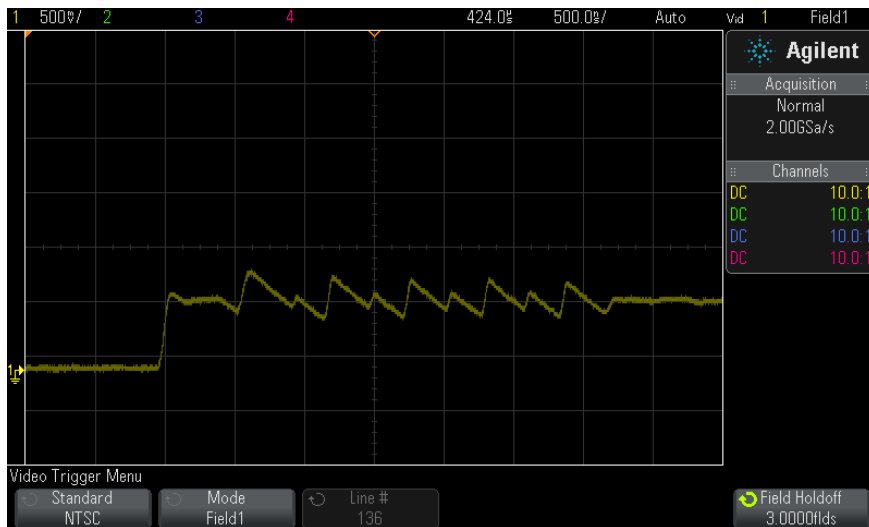
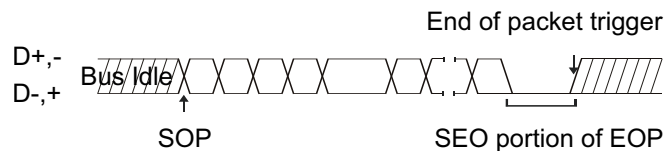

Figure 32 Using Field Holdoff to Synchronize to Color Field 1 or 3 (Field 1 mode)

USB Trigger

USB trigger will trigger on a Start of Packet (SOP), End of Packet (EOP), Reset Complete (RC), Enter Suspend (Suspend), or Exit Suspend (Exit Sus) on the differential USB data lines (D+ and D-). USB Low Speed and Full Speed are supported by this trigger.



- 1 Press **[Default Setup]**.
- 2 Press the **[Label]** key to switch labels on.
- 3 Turn on any analog or digital channels that you will be using for the USB signals.
- 4 Press the **[Trigger]** key.

10 Triggers

- 5 In the Trigger Menu, press the **Trigger** softkey; then, turn the Entry knob to select **USB**.

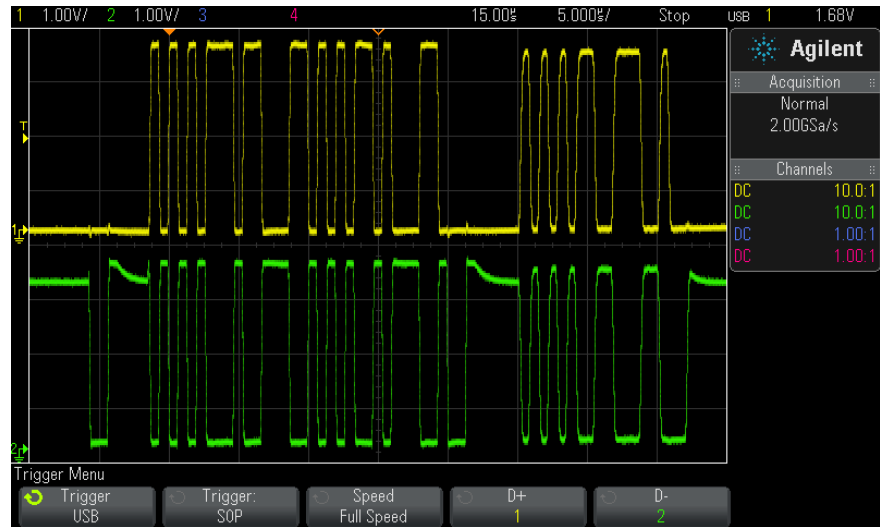

- 6 Press the **Trigger:** softkey to select where the USB trigger will occur:
 - **SOP** (Start of Packet) – triggers at the Sync bit at the beginning of the packet.
 - **EOP** (End of Packet) – triggers at the end of the SE0 portion of the EOP.
 - **RC** (Reset Complete) – triggers when SE0 is > 10 ms.
 - **Suspend** (Enter Suspend) – triggers when the bus is idle > 3 ms.
 - **Exit Sus** (Exit Suspend) – triggers when exiting an idle state > 10 ms. This is used to see the suspend/resume transition.
- 7 Press the **Speed** softkey to select the speed of the transaction being probed.

You may select Low Speed (1.5 Mb/s) or Full Speed (12 Mb/s).

- 8 Press the **D+** and **D-** softkeys to select the channel connected to the USB signal D+ and D- lines. The D+ and D- labels for the source channels are automatically set.

As you press the **D+** or **D-** softkey (or rotate the Entry knob), the D+ and D- label for the source channel is automatically set and the channel you select is shown in the upper-right corner of the display next to "USB".

If you have connected the oscilloscope's analog source channels to the D+ and D- signals: Adjust the trigger level for each connected analog channel to the middle of the waveform by pressing the **D+** or **D-** softkey, then turning the Trigger Level knob.

If you have connected the oscilloscope's digital source channels to the D+ and D- signals (this applies to MSO model oscilloscopes only): Press the **[Digital]** key and select **Thresholds** to set an appropriate threshold level for the digital channels.

The value of the trigger level or digital threshold is displayed in the upper-right corner of the display.

Serial Trigger

With serial decode option licenses (see ["Serial Decode Options"](#) on page 125), you can enable serial trigger types. To set up these triggers, see:

- ["ARINC 429 Triggering"](#) on page 415
- ["CAN Triggering"](#) on page 353
- ["FlexRay Triggering"](#) on page 368
- ["I2C Triggering"](#) on page 378
- ["I2S Triggering"](#) on page 400
- ["LIN Triggering"](#) on page 361
- ["MIL-STD-1553 Triggering"](#) on page 409
- ["SPI Triggering"](#) on page 389
- ["UART/RS232 Triggering"](#) on page 425



11 Trigger Mode/Coupling

- To select the Auto or Normal trigger mode [180](#)
- To select the trigger coupling [182](#)
- To enable or disable trigger noise rejection [183](#)
- To enable or disable trigger HF Reject [183](#)
- To set the trigger holdoff [184](#)
- External Trigger Input [184](#)

To access the Trigger Mode and Coupling Menu:

- In the Trigger section of the front panel, press the **[Mode/Coupling]** key.



Noisy Signals

If the signal you are probing is noisy, you can set up the oscilloscope to reduce the noise in the trigger path and on the displayed waveform. First, stabilize the displayed waveform by removing the noise from the trigger path. Second, reduce the noise on the displayed waveform.

- 1 Connect a signal to the oscilloscope and obtain a stable display.
- 2 Remove the noise from the trigger path by turning on high-frequency rejection ("[To enable or disable trigger HF Reject](#)" on page 183), low-frequency rejection ("[To select the trigger coupling](#)" on page 182), or "[To enable or disable trigger noise rejection](#)" on page 183.
- 3 Use "[Averaging Acquisition Mode](#)" on page 197 to reduce noise on the displayed waveform.



To select the Auto or Normal trigger mode

When the oscilloscope is running, the trigger mode tells the oscilloscope what to do when triggers are not occurring.

In the **Auto** trigger mode (the default setting), if the specified trigger conditions are not found, triggers are forced and acquisitions are made so that signal activity is displayed on the oscilloscope.

In the **Normal** trigger mode, triggers and acquisitions only occur when the specified trigger conditions are found.

To select the trigger mode:

- 1 Press the **[Mode/Coupling]** key.
- 2 In the Trigger Mode and Coupling Menu, press the **Mode** softkey; then select either **Auto** or **Normal**.

See the following "[When to Use Auto Trigger Mode](#)" on page 181 and "[When to Use Normal Trigger Mode](#)" on page 181 descriptions.

You can also configure the **[Quick Action]** key to toggle between the Auto and Normal trigger modes. See "[Configuring the \[Quick Action\] Key](#)" on page 311.

Triggering and the Pre- and Post-Trigger Buffers

After the oscilloscope starts running (after pressing **[Run]** or **[Single]** or changing the trigger condition), the oscilloscope first fills the pre-trigger buffer. Then, after the pre-trigger buffer is filled, the oscilloscope starts searching for a trigger, and sampled data continues to flow data through the pre-trigger buffer in a first-in first-out (FIFO) manner.

When a trigger is found, the pre-trigger buffer contains the events that occurred just before the trigger. Then, the oscilloscope fills the post-trigger buffer and displays the acquisition memory. If the acquisition was initiated by **[Run/Stop]**, the process repeats. If the acquisition was initiated by pressing **[Single]**, the acquisition stops (and you can Pan and Zoom the waveform).

In either Auto or Normal trigger mode, a trigger may be missed if the event occurs while the pre-trigger buffer is being filled. This may be more likely, for example, when the horizontal scale knob is set to a slow time/div setting, such as 500 ms/div.

Trigger Indicator The trigger indicator at the top right of the display shows whether triggers are occurring.

In the **Auto** trigger mode, the trigger indicator can show:

- **Auto?** (flashing) – the trigger condition is not found (after the pre-trigger buffer has filled), and forced triggers and acquisitions are occurring.
- **Auto** (not flashing) – the trigger condition is found (or the pre-trigger buffer is being filled).

In the **Normal** trigger mode, the trigger indicator can show:

- **Trig'd?** (flashing) – the trigger condition is not found (after the pre-trigger buffer has filled), and no acquisitions are occurring.
- **Trig'd** (not flashing) – trigger condition is found (or pre-trigger buffer is being filled).

When the oscilloscope is not running, the trigger indicator area shows **Stop**.

When to Use Auto Trigger Mode

The **Auto** trigger mode is appropriate when:

- Checking DC signals or signals with unknown levels or activity.
- When trigger conditions occur often enough that forced triggers are unnecessary.

When to Use Normal Trigger Mode

The **Normal** trigger mode is appropriate when:

- You only want to acquire specific events specified by the trigger settings.
- Triggering on an infrequent signal from a serial bus (for example, I2C, SPI, CAN, LIN, etc.) or another signal that arrives in bursts. The **Normal** trigger mode lets you stabilize the display by preventing the oscilloscope from auto-triggering.
- Making single-shot acquisitions with the [**Single**] key.

Often with single-shot acquisitions, you must initiate some action in the device under test, and you don't want the oscilloscope to auto-trigger before that happens. Before initiating the action in the circuit, wait for the trigger condition indicator **Trig'd?** to flash (this tells you the pre-trigger buffer is filled).

- See Also**
- "[Forcing a Trigger](#)" on page 145
 - "[To set the trigger holdoff](#)" on page 184

11 Trigger Mode/Coupling

- "To position the time reference (left, center, right)" on page 58

To select the trigger coupling

- 1 Press the [**Mode/Coupling**] key.
- 2 In the Trigger Mode and Coupling Menu, press the **Coupling** softkey; then, turn the Entry knob to select:

- **DC** coupling – allows DC and AC signals into the trigger path.
- **AC** coupling – places a 10 Hz high-pass filter in the trigger path removing any DC offset voltage from the trigger waveform.

The high-pass filter in the External Trigger input path is 50 Hz for all models.

Use AC coupling to get a stable edge trigger when your waveform has a large DC offset.

- **LF** (low frequency) **Reject** coupling – adds a high-pass filter with the 3-dB point at 50 kHz in series with the trigger waveform.

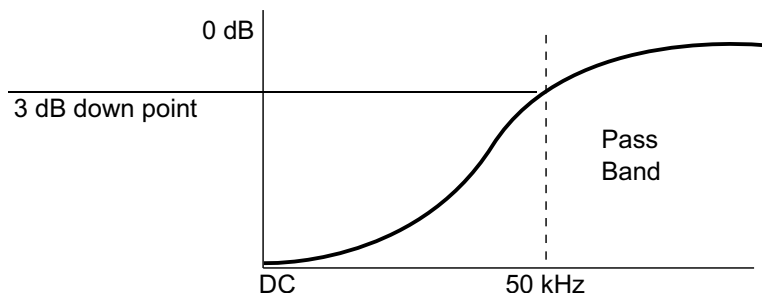

Low frequency reject removes any unwanted low frequency components from a trigger waveform, such as power line frequencies, etc., that can interfere with proper triggering.

Use **LF Reject** coupling to get a stable edge trigger when your waveform has low frequency noise.

- **TV** coupling – is normally grayed-out, but is automatically selected when TV trigger is enabled in the Trigger Menu.

Note that Trigger Coupling is independent of Channel Coupling (see "To specify channel coupling" on page 65).

To enable or disable trigger noise rejection

Noise Rej adds additional hysteresis to the trigger circuitry. By increasing the trigger hysteresis band, you reduce the possibility of triggering on noise. However, this also decreases the trigger sensitivity so that a slightly larger signal is required to trigger the oscilloscope.

- 1 Press the **[Mode/Coupling]** key.
- 2 In the Trigger Mode and Coupling Menu, press the **Noise Rej** softkey to enable or disable.

To enable or disable trigger HF Reject

HF Reject adds a 50 kHz low-pass filter in the trigger path to remove high frequency components from the trigger waveform.

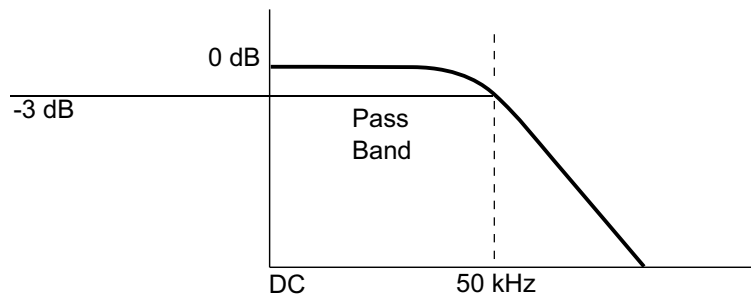

You can use HF Reject to remove high-frequency noise, such as AM or FM broadcast stations or noise from fast system clocks, from the trigger path.

- 1 Press the **[Mode/Coupling]** key.
- 2 In the Trigger Mode and Coupling Menu, press the **HF Reject** softkey to enable or disable.

To set the trigger holdoff

Trigger holdoff sets the amount of time the oscilloscope waits after a trigger before re-arming the trigger circuitry.

Use the holdoff to trigger on repetitive waveforms that have multiple edges (or other events) between waveform repetitions. You can also use holdoff to trigger on the first edge of a burst when you know the minimum time between bursts.

For example, to get a stable trigger on the repetitive pulse burst shown below, set the holdoff time to be >200 ns but <600 ns.

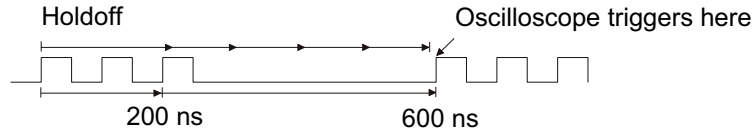

To set the trigger holdoff:

- 1 Press the **[Mode/Coupling]** key.
- 2 In the Trigger Mode and Coupling Menu, press the **Holdoff** softkey; then, turn the Entry knob to increase or decrease the trigger holdoff time.

Trigger Holdoff Operating Hints

The correct holdoff setting is typically slightly less than one repetition of the waveform. Set the holdoff to this time to generate a unique trigger point for a repetitive waveform.

Changing the time base settings does not affect the trigger holdoff time.

With Agilent's MegaZoom technology, you can press **[Stop]**, then pan and zoom through the data to find where the waveform repeats. Measure this time using cursors; then, set the holdoff.

External Trigger Input

The external trigger input can be used as a source in several of the trigger types. The external trigger BNC input is on the rear panel and is labeled **EXT TRIG IN**.

CAUTION**⚠ Maximum voltage at oscilloscope external trigger input**

CAT I 300 Vrms, 400 Vpk; transient overvoltage 1.6 kVpk

1 M ohm input: For steady-state sinusoidal waveforms derate at 20 dB/decade above 57 kHz to a minimum of 5 Vpk

With N2863A 10:1 probe: CAT I 600 V, CAT II 300 V (DC + peak AC)

With 10073C or 10074C 10:1 probe: CAT I 500 Vpk, CAT II 400 Vpk

The external trigger input impedance is 1M Ohm. This lets you use passive probes for general-purpose measurements. The higher impedance minimizes the loading effect of the oscilloscope on the device under test.

To set the EXT TRIG IN units and probe attenuation:

- 1 Press the **[Mode/Coupling]** key in the Trigger section of the front panel.



- 2 In the Trigger Mode and Coupling Menu, press the **External** softkey.



- 3 In the External Trigger Menu, press the **Units** softkey to select between:
 - **Volts** – for a voltage probe.
 - **Amps** – for a current probe.

Measurement results, channel sensitivity, and the trigger level will reflect the measurement units you have selected.

- 4 Press the **Probe** softkey; then, turn the entry knob to specify the probe attenuation.

The attenuation factor can be set from 0.1:1 to 1000:1 in a 1-2-5 sequence.

The probe attenuation factor must be set properly for measurements to be made correctly.

11 Trigger Mode/Coupling



12 Acquisition Control

Running, Stopping, and Making Single Acquisitions (Run Control)	187
Overview of Sampling	189
Selecting the Acquisition Mode	193
Acquiring to Segmented Memory	199

This chapter shows how to use the oscilloscope's acquisition and run controls.

Running, Stopping, and Making Single Acquisitions (Run Control)

There are two front panel keys for starting and stopping the oscilloscope's acquisition system: **[Run/Stop]** and **[Single]**.

- When the **[Run/Stop]** key is green, the oscilloscope is running, that is, acquiring data when trigger conditions are met.

To stop acquiring data, press **[Run/Stop]**. When stopped, the last acquired waveform is displayed.

- When the **[Run/Stop]** key is red, data acquisition is stopped.

"Stop" is displayed next to the trigger type in the status line at the top of the display.

To start acquiring data, press **[Run/Stop]**.

- To capture and display a single acquisition (whether the oscilloscope is running or stopped), press **[Single]**.

The **[Single]** run control lets you view single-shot events without subsequent waveform data overwriting the display. Use **[Single]** when you want maximum memory depth for pan and zoom.



12 Acquisition Control

When you press **[Single]**, the display is cleared, the trigger mode is temporarily set to Normal (to keep the oscilloscope from auto-triggering immediately), the trigger circuitry is armed, the **[Single]** key is illuminated, and the oscilloscope waits until a trigger condition occurs before it displays a waveform.

When the oscilloscope triggers, the single acquisition is displayed and the oscilloscope is stopped (the **[Run/Stop]** key is illuminated in red). Press **[Single]** again to acquire another waveform.

If the oscilloscope doesn't trigger, you can press the **[Force Trigger]** key to trigger on anything and make a single acquisition.

To display the results of multiple acquisitions, use persistence. See "[To set or clear persistence](#)" on page 133.

Single vs. Running and Record Length

The maximum data record length is greater for a single acquisition than when the oscilloscope is running (or when the oscilloscope is stopped after running):

- **Single** – Single acquisitions always use the maximum memory available – at least twice as much memory as acquisitions captured when running – and the oscilloscope stores at least twice as many samples. At slower time/div settings, because there is more memory available for a single acquisition, the acquisition has a higher effective sample rate.
- **Running** – When running (versus taking a single acquisition), the memory is divided in half. This lets the acquisition system acquire one record while processing the previous acquisition, dramatically improving the number of waveforms per second processed by the oscilloscope. When running, a high waveform update rate provides the best representation of your input signal.

To acquire data with the longest possible record length, press the **[Single]** key.

For more information on settings that affect record length, see "[Length Control](#)" on page 279.

Overview of Sampling

To understand the oscilloscope's sampling and acquisition modes, it is helpful to understand sampling theory, aliasing, oscilloscope bandwidth and sample rate, oscilloscope rise time, oscilloscope bandwidth required, and how memory depth affects sample rate.

Sampling Theory

The Nyquist sampling theorem states that for a limited bandwidth (band-limited) signal with maximum frequency f_{MAX} , the equally spaced sampling frequency f_{S} must be greater than twice the maximum frequency f_{MAX} , in order to have the signal be uniquely reconstructed without aliasing.

$$f_{\text{MAX}} = f_{\text{S}}/2 = \text{Nyquist frequency } (f_{\text{N}}) = \text{folding frequency}$$

Aliasing

Aliasing occurs when signals are under-sampled ($f_{\text{S}} < 2f_{\text{MAX}}$). Aliasing is the signal distortion caused by low frequencies falsely reconstructed from an insufficient number of sample points.

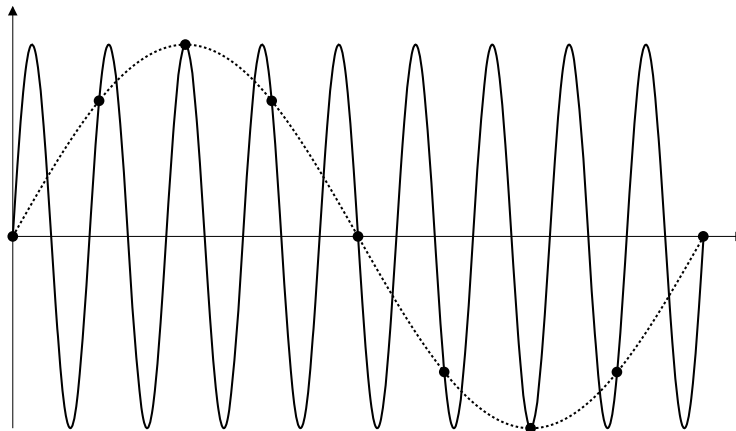

Figure 33 Aliasing

Oscilloscope Bandwidth and Sample Rate

An oscilloscope's bandwidth is typically described as the lowest frequency at which input signal sine waves are attenuated by 3 dB (-30% amplitude error).

At the oscilloscope bandwidth, sampling theory says the required sample rate is $f_S = 2f_{BW}$. However, the theory assumes there are no frequency components above f_{MAX} (f_{BW} in this case) and it requires a system with an ideal brick-wall frequency response.

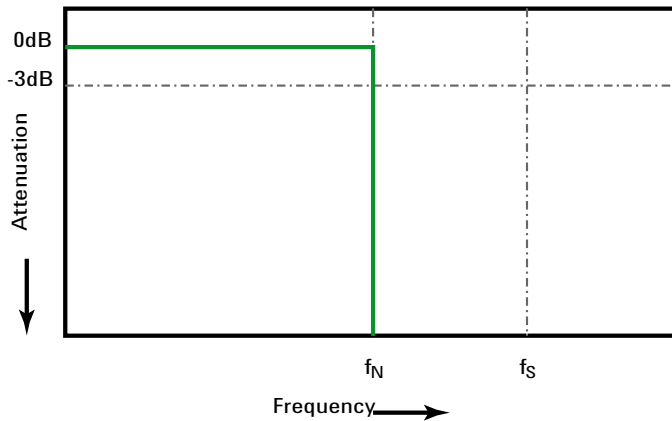
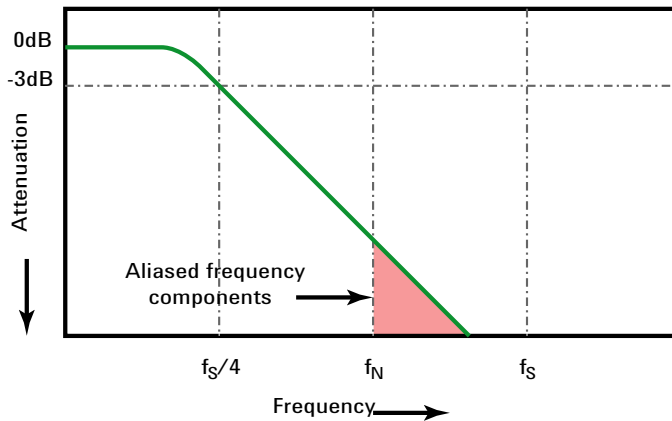

Figure 34 Theoretical Brick-Wall Frequency Response

However, digital signals have frequency components above the fundamental frequency (square waves are made up of sine waves at the fundamental frequency and an infinite number of odd harmonics), and typically, for 500 MHz bandwidths and below, oscilloscopes have a Gaussian frequency response.



Limiting oscilloscope bandwidth (fbw) to 1/4 the sample rate ($f_s/4$) reduces frequency components above the Nyquist frequency (f_N).

Figure 35 Sample Rate and Oscilloscope Bandwidth

So, in practice, an oscilloscope's sample rate should be four or more times its bandwidth: $f_s = 4f_{BW}$. This way, there is less aliasing, and aliased frequency components have a greater amount of attenuation.

Note that 1 GHz bandwidth 3000 X-Series oscilloscope models have more of a brick-wall type frequency response (also known as a flat response) than the Gaussian response of lower bandwidth 3000 X-Series oscilloscope models. To understand the characteristics of each type of oscilloscope frequency response, see *Understanding Oscilloscope Frequency Response and Its Effect on Rise-Time Accuracy*, Agilent Application Note 1420 ("<http://cp.literature.agilent.com/litweb/pdf/5988-8008EN.pdf>").

See Also *Evaluating Oscilloscope Sample Rates vs. Sampling Fidelity: How to Make the Most Accurate Digital Measurements*, Agilent Application Note 1587 ("<http://cp.literature.agilent.com/litweb/pdf/5989-5732EN.pdf>")

Oscilloscope Rise Time

Closely related to an oscilloscope's bandwidth specification is its rise time specification. Oscilloscopes with a Gaussian-type frequency response have an approximate rise time of $0.35/f_{BW}$ based on a 10% to 90% criterion.

An oscilloscope's rise time is not the fastest edge speed that the oscilloscope can accurately measure. It is the fastest edge speed the oscilloscope can possibly produce.

Oscilloscope Bandwidth Required

The oscilloscope bandwidth required to accurately measure a signal is primarily determined by the signal's rise time, not the signal's frequency. You can use these steps to calculate the oscilloscope bandwidth required:

- 1 Determine the fastest edge speeds.

You can usually obtain rise time information from published specifications for devices used in your designs.

- 2 Compute the maximum "practical" frequency component.

From Dr. Howard W. Johnson's book, *High-Speed Digital Design - A Handbook of Black Magic*, all fast edges have an infinite spectrum of frequency components. However, there is an inflection (or "knee") in the frequency spectrum of fast edges where frequency components higher than f_{knee} are insignificant in determining the shape of the signal.

$$f_{knee} = 0.5 / \text{signal rise time (based on 10\% - 90\% thresholds)}$$

$$f_{knee} = 0.4 / \text{signal rise time (based on 20\% - 80\% thresholds)}$$

- 3 Use a multiplication factor for the required accuracy to determine the oscilloscope bandwidth required.

Required accuracy	Oscilloscope bandwidth required
20%	$f_{BW} = 1.0 \times f_{knee}$
10%	$f_{BW} = 1.3 \times f_{knee}$
3%	$f_{BW} = 1.9 \times f_{knee}$

See Also *Choosing an Oscilloscope with the Right Bandwidth for your Application*, Agilent Application Note 1588 (<http://cp.literature.agilent.com/litweb/pdf/5989-5733EN.pdf>)

Memory Depth and Sample Rate

The number of points of oscilloscope memory is fixed, and there is a maximum sample rate associated with oscilloscope's analog-to-digital converter; however, the actual sample rate is determined by the time of the acquisition (which is set according to the oscilloscope's horizontal time/div scale).

$$\text{sample rate} = \text{number of samples} / \text{time of acquisition}$$

For example, when storing 50 μs of data in 50,000 points of memory, the actual sample rate is 1 GSa/s.

Likewise, when storing 50 ms of data in 50,000 points of memory, the actual sample rate is 1 MSa/s.

The actual sample rate is displayed in the right-side information area.

The oscilloscope achieves the actual sample rate by throwing away (decimating) unneeded samples.

Selecting the Acquisition Mode

When selecting the oscilloscope acquisition mode, keep in mind that samples are normally decimated at slower time/div settings.

At slower time/div settings, the effective sample rate drops (and the effective sample period increases) because the acquisition time increases and the oscilloscope's digitizer is sampling faster than is required to fill memory.

For example, suppose an oscilloscope's digitizer has a sample period of 1 ns (maximum sample rate of 1 GSa/s) and a 1 M memory depth. At that rate, memory is filled in 1 ms. If the acquisition time is 100 ms (10 ms/div), only 1 of every 100 samples is needed to fill memory.

To select the acquisition mode:

- 1 Press the **[Acquire]** key on the front panel.
- 2 In the Acquire Menu, press the **Acq Mode** softkey; then, turn the Entry knob to select the acquisition mode.

The InfiniiVision oscilloscopes have the following acquisition modes:

- **Normal** – at slower time/div settings, normal decimation occurs, and there is no averaging. Use this mode for most waveforms. See "[Normal Acquisition Mode](#)" on page 194.
- **Peak Detect** – at slower time/div settings, the maximum and minimum samples in the effective sample period are stored. Use this mode for displaying narrow pulses that occur infrequently. See "[Peak Detect Acquisition Mode](#)" on page 194.
- **Averaging** – at all time/div settings, the specified number of triggers are averaged together. Use this mode for reducing noise and increasing resolution of periodic signals without bandwidth or rise time degradation. See "[Averaging Acquisition Mode](#)" on page 197.
- **High Resolution** – at slower time/div settings, all samples in the effective sample period are averaged and the average value is stored. Use this mode for reducing random noise. See "[High Resolution Acquisition Mode](#)" on page 199.

Normal Acquisition Mode

In Normal mode at slower time/div settings, extra samples are decimated (in other words, some are thrown away). This mode yields the best display for most waveforms.

Peak Detect Acquisition Mode

In Peak Detect mode at slower time/div settings, minimum and maximum samples are kept in order to capture infrequent and narrow events (at the expense of exaggerating any noise). This mode displays all pulses that are at least as wide as the sample period.

For InfiniiVision 3000 X-Series oscilloscopes, which have a maximum sample rate of 4 GSa/s, a sample is taken every 250 ps (sample period).

- See Also**
- "[Glitch or Narrow Pulse Capture](#)" on page 195
 - "[Using Peak Detect Mode to Find a Glitch](#)" on page 196

Glitch or Narrow Pulse Capture

A glitch is a rapid change in the waveform that is usually narrow as compared to the waveform. Peak detect mode can be used to more easily view glitches or narrow pulses. In peak detect mode, narrow glitches and sharp edges are displayed more brightly than when in Normal acquire mode, making them easier to see.

To characterize the glitch, use the cursors or the automatic measurement capabilities of the oscilloscope.

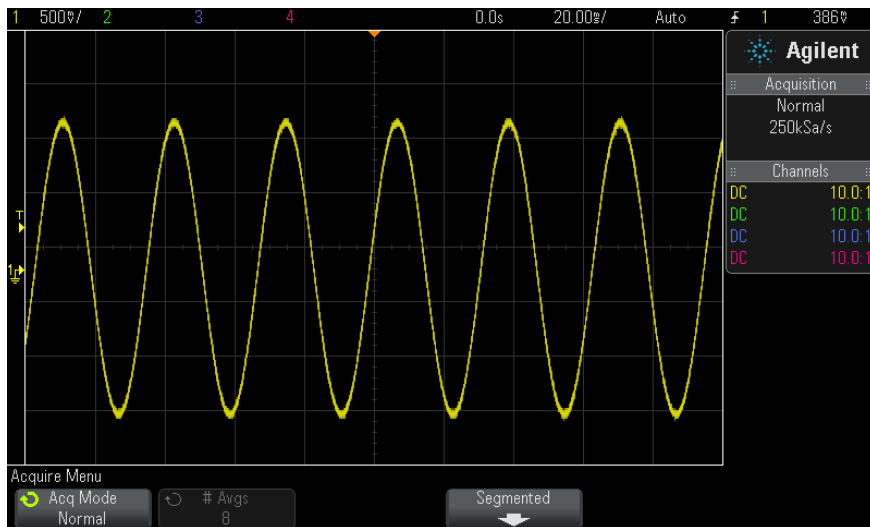

Figure 36 Sine With Glitch, Normal Mode

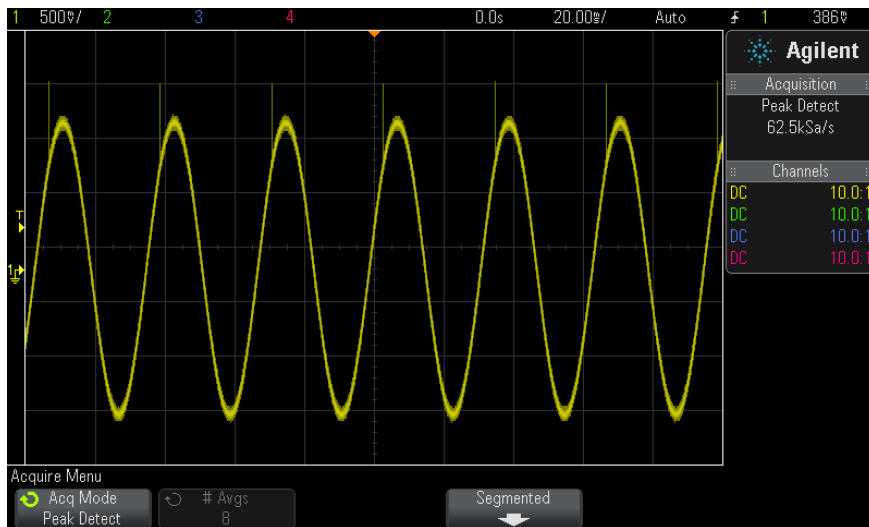

Figure 37 Sine With Glitch, Peak Detect Mode

Using Peak Detect Mode to Find a Glitch

- 1 Connect a signal to the oscilloscope and obtain a stable display.
- 2 To find the glitch, press the **[Acquire]** key; then, press the **Acq Mode** softkey until **Peak Detect** is selected.
- 3 Press the **[Display]** key then press the ∞ **Persistence** (infinite persistence) softkey.

Infinite persistence updates the display with new acquisitions but does not erase previous acquisitions. New sample points are shown at normal intensity while previous acquisitions are displayed at reduced intensity. Waveform persistence is not kept beyond the display area boundary.

Press the **Clear Display** softkey to erase previously acquired points. The display will accumulate points until ∞ **Persistence** is turned off.

- 4 Characterize the glitch with Zoom mode:
 - a Press the \textcircled{C} zoom key (or press the **[Horiz]** key and then the **Zoom** softkey).
 - b To obtain a better resolution of the glitch, expand the time base.

Use the horizontal position knob (◀▶) to pan through the waveform to set the expanded portion of the normal window around the glitch.

Averaging Acquisition Mode

The Averaging mode lets you average multiple acquisitions together to reduce noise and increase vertical resolution (at all time/div settings). Averaging requires a stable trigger.

The number of averages can be set from 2 to 65536 in power-of-2 increments.

A higher number of averages reduces noise more and increases vertical resolution.

# Avgs	Bits of resolution
2	8
4	9
16	10
64	11
≥ 256	12

The higher the number of averages, the slower the displayed waveform responds to waveform changes. You must compromise between how quickly the waveform responds to changes and how much you want to reduce the displayed noise on the signal.

To use the Averaging mode:

- 1 Press the **[Acquire]** key, then press the **Acq Mode** softkey until the Averaging mode is selected.
- 2 Press the **#Avgs** softkey and turn the Entry knob to set the number of averages that best eliminates the noise from the displayed waveform. The number of acquisitions being averaged is displayed in the **# Avgs** softkey.

12 Acquisition Control

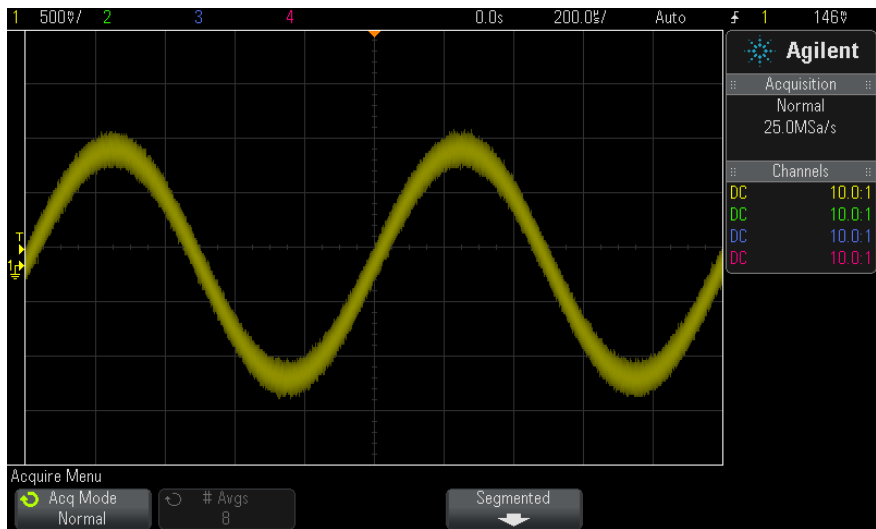

Figure 38 Random noise on the displayed waveform

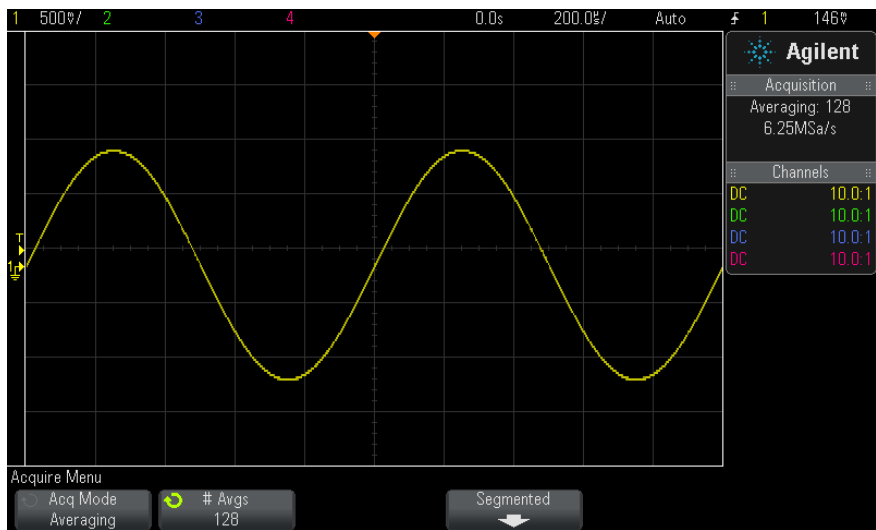

Figure 39 128 Averages used to reduce random noise

See Also • [Chapter 11](#), “Trigger Mode/Coupling,” starting on page 179

High Resolution Acquisition Mode

In High Resolution mode, at slower time/div settings extra samples are averaged in order to reduce random noise, produce a smoother trace on the screen, and effectively increase vertical resolution.

High Resolution mode averages sequential sample points within the same acquisition. An extra bit of vertical resolution is produced for every factor of 4 averages. The number of extra bits of vertical resolution is dependent on the time per division setting (sweep speed) of the oscilloscope.

The slower the time/div setting, the greater the number of samples that are averaged together for each display point.

High Resolution mode can be used on both single-shot and repetitive signals and it does not slow waveform update because the computation is done in the MegaZoom custom ASIC. High Resolution mode limits the oscilloscope's real-time bandwidth because it effectively acts like a low-pass filter.

Displayed Sample Rate (sr, per channel, 2 Gsa/s max)	Displayed Sample Rate (sr, interleaved, 4 Gsa/s max)	Bits of resolution
500 MSa/s < sr ≤ 2 Gsa/s	1 GSa/s < sr ≤ 4 Gsa/s	8
100 MSa/s < sr ≤ 500 MSa/s	200 MSa/s < sr ≤ 1 GSa/s	9
20 MSa/s < sr ≤ 100 MSa/s	40 MSa/s < sr ≤ 200 MSa/s	10
5 MSa/s < sr ≤ 20 MSa/s	10 MSa/s < sr ≤ 40 MSa/s	11
sr ≤ 5 MSa/s	sr ≤ 10 MSa/s	12

Acquiring to Segmented Memory

You can purchase the oscilloscope with the segmented memory option factory-installed (Option SGM) or you can install a license to enable it (order model number DSOX3SGM "Segmented Memory").

12 Acquisition Control

When capturing multiple infrequent trigger events it is advantageous to divide the oscilloscope's memory into segments. This lets you capture signal activity without capturing long periods of signal inactivity.

Each segment is complete with all analog channel, digital channel (on MSO models), and serial decode data.

When using segmented memory, use the Analyze Segments feature (see ["Measurements, Statistics, and Infinite Persistence with Segmented Memory"](#) on page 201) to show infinite persistence across all acquired segments. See also ["To set or clear persistence"](#) on page 133 for details.

To acquire to segmented memory

- 1 Set up a trigger condition. (See [Chapter 10](#), "Triggers," starting on page 143 for details.)
- 2 Press the **[Acquire]** key in the Waveform section of the front panel.
- 3 Press the **Segmented** softkey.
- 4 In the Segmented Memory Menu, press the **Segmented** softkey to enable segmented memory acquisitions.
- 5 Press the **# of Segs** softkey and turn the Entry knob to select the number of segments into which you would like to divide the oscilloscope's memory.

Memory can be divided into as few as two segments and as many as 1000 segments, depending on the oscilloscope model.

- 6 Press the **[Run]** or **[Single]** key.

The oscilloscope runs and fills a memory segment for each trigger event. When the oscilloscope is busy acquiring multiple segments, the progress is displayed in the upper right area of the display. The oscilloscope continues to trigger until memory is filled, then the oscilloscope stops.

If the signal you are measuring has more than about 1 s of inactivity, consider selecting the **Normal** trigger mode to prevent AutoTriggering. See ["To select the Auto or Normal trigger mode"](#) on page 180.

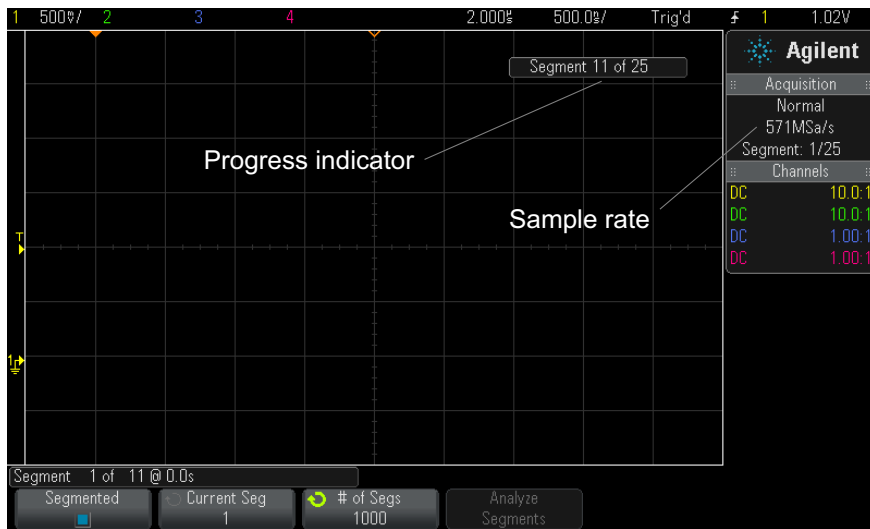

- See Also**
- ["Navigating Segments"](#) on page 201
 - ["Measurements, Statistics, and Infinite Persistence with Segmented Memory"](#) on page 201
 - ["Segmented Memory Re-Arm Time"](#) on page 202
 - ["Saving Data from Segmented Memory"](#) on page 202

Navigating Segments

- 1 Press the **Current Seg** softkey and turn the Entry knob to display the desired segment along with a time tag indicating the time from the first trigger event.

You can also navigate segments using the **[Navigate]** key and controls. See ["To navigate segments"](#) on page 62.

Measurements, Statistics, and Infinite Persistence with Segmented Memory

To perform measurements and view statistical information, press **[Meas]** and set up your desired measurements (see [Chapter 14](#), "Measurements," starting on page 215). Then, press **Analyze Segments**. Statistical data will be accumulated for the measurements you have chosen.

12 Acquisition Control

The **Analyze Segments** softkey appears when the acquisition is stopped and the segmented memory feature is on or when the serial Lister is enabled.

You can also turn on infinite persistence (in the Display Menu) and press the **Analyze Segments** softkey to create an infinite persistence display.

Segmented Memory Re-Arm Time

After each segment fills, the oscilloscope re-arms and is ready to trigger in about 1 μ s.

Remember though, for example: if the horizontal time per division control is set to 5 μ s/div, and the Time Reference is set to **Center**, it will take at least 50 μ s to fill all ten divisions and re-arm. (That is 25 μ s to capture pre-trigger data and 25 μ s to capture post-trigger data.)

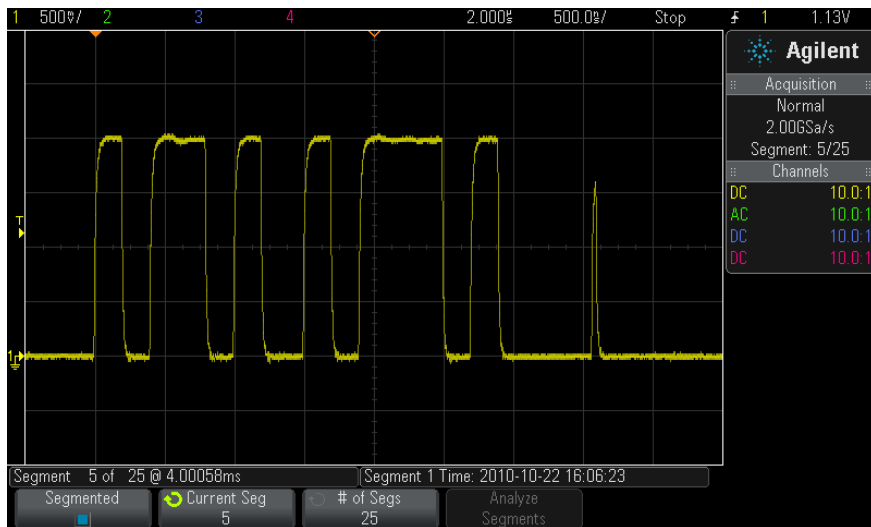

Saving Data from Segmented Memory

You can save either the currently displayed segment (**Save Segment - Current**), or all segments (**Save Segment - All**) in the following data formats: CSV, ASCII XY, and BIN.

Be sure to set the Length control to capture enough points to accurately represent the captured data. When the oscilloscope is busy saving multiple segments, progress is displayed in the upper right area of the display.

For more information, see "[To save CSV, ASCII XY, or BIN data files](#)" on page 277.

12 Acquisition Control



13 Cursors

To make cursor measurements 206

Cursor Examples 209

Cursors are horizontal and vertical markers that indicate X-axis values and Y-axis values on a selected waveform source. You can use cursors to make custom voltage, time, phase, or ratio measurements on oscilloscope signals.

Cursor information is displayed in the right-side information area.

Cursors are not always limited to the visible display. If you set a cursor, then pan and zoom the waveform until the cursor is off screen, its value will not be changed. It will still be there when you return to its original location.

X Cursors X cursors are vertical dashed lines that adjust horizontally and can be used to measure time (s), frequency (1/s), phase ($^{\circ}$), and ratio (%).

The X1 cursor is the short-dashed vertical line, and the X2 cursor is the long-dashed vertical line.

When used with the FFT math function as a source, the X cursors indicate frequency.

In XY horizontal mode, the X cursors display channel 1 values (Volts or Amps).

The X1 and X2 cursor values for the selected waveform source are displayed in the softkey menu area.

The difference between X1 and X2 (ΔX) and $1/\Delta X$ are displayed in the Cursors box in the right-side information area.



13 Cursors

Y Cursors Y cursors are horizontal dashed lines that adjust vertically and can be used to measure Volts or Amps, dependent on the channel **Probe Units** setting, or they can measure ratios (%). When math functions are used as a source, the measurement units correspond to that math function.

The Y1 cursor is the short-dashed horizontal line and the Y2 cursor is the long-dashed horizontal line.

The Y cursors adjust vertically and typically indicate values relative to the waveform's ground point, except math FFT where the values are relative to 0 dB.

In XY horizontal mode, the Y cursors display channel 2 values (Volts or Amps).

When active, the Y1 and Y2 cursor values for the selected waveform source are displayed in the softkey menu area.

The difference between Y1 and Y2 (ΔY) is displayed in the Cursors box in the right-side information area.

To make cursor measurements

- 1 Connect a signal to the oscilloscope and obtain a stable display.
- 2 Press the [**Cursors**] key.

The Cursors box in the right-side information area appears, indicating that cursors are "on". (Press the [**Cursors**] key again when you want to turn cursors off.)

- 3 In the Cursors Menu, press **Mode**; then, select the desired mode:
 - **Manual** – ΔX , $1/\Delta X$, and ΔY values are displayed. ΔX is the difference between the X1 and X2 cursors and ΔY is the difference between the Y1 and Y2 cursors.



- **Track Waveform** – As you move a marker horizontally, the vertical amplitude of the waveform is tracked and measured. The time and voltage positions are shown for the markers. The vertical (Y) and horizontal (X) differences between the markers are shown as ΔX and ΔY values.
- **Binary** – Logic levels of displayed waveforms at the current X1 and X2 cursor positions are displayed above the softkeys in binary. The display is color coded to match the color of the related channel's waveform.



- **Hex** – Logic levels of displayed waveforms at the current X1 and X2 cursor positions are displayed above the softkeys in hexadecimal.



Manual and **Track Waveform** modes can be used on waveforms that are displayed on the analog input channels (including math functions).

Binary and **Hex** modes apply to digital signals (of MSO oscilloscope models).

In **Hex** and **Binary** modes, a level can be displayed as 1 (higher than trigger level), 0 (lower than trigger level), indeterminate state (\updownarrow), or X (don't care).

In **Binary** mode, X is displayed if the channel is turned off.

In **Hex** mode, the channel is interpreted as 0 if turned off.

- 4 Press **Source** (or **X1 Source**, **X2 Source** in the **Track Waveform** mode); then, select the input source for cursor values.
- 5 Select the cursor(s) to be adjusted:
 - Push the Cursors knob; then, turn the Cursors knob. To finalize your selection, either push the Cursors knob again or wait about five seconds for the popup menu to disappear.

Or:

13 Cursors

- Press the **Cursors** softkey; then, turn the Entry knob.

The **X1 X2 linked** and **Y1 Y2 linked** selections let you adjust both cursors at the same time, while the delta value remains the same. This can be useful, for example, for checking pulse width variations in a pulse train.

The currently selected cursor(s) display brighter than the other cursors.

- 6 To change the cursor units, press the **Units** softkey.

In the Cursor Units Menu:



You can press the **X Units** softkey to select:

- **Seconds (s)**.
- **Hz (1/s)**.
- **Phase (°)** – when selected, use the **Use X Cursors** softkey to set the current X1 location as 0 degrees and the current X2 location as 360 degrees.
- **Ratio (%)** – when selected, use the **Use X Cursors** softkey to set the current X1 location as 0% and the current X2 location as 100%.

You can press the **Y Units** softkey to select:

- **Base** – the same units used for the source waveform.
- **Ratio (%)** – when selected, use the **Use Y Cursors** softkey to set the current Y1 location as 0% and the current Y2 location as 100%.

For phase or ratio units, once the 0 and 360 degree or 0 and 100% locations are set, adjusting cursors will display measurements relative to the set locations.

- 7 Adjust the selected cursor(s) by turning the Cursors knob.

Cursor Examples

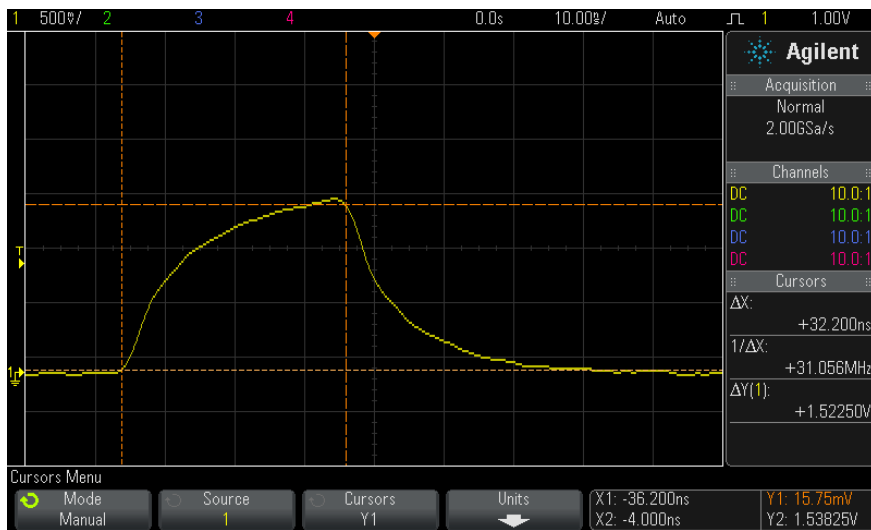

Figure 40 Cursors used to measure pulse widths other than middle threshold points

13 Cursors

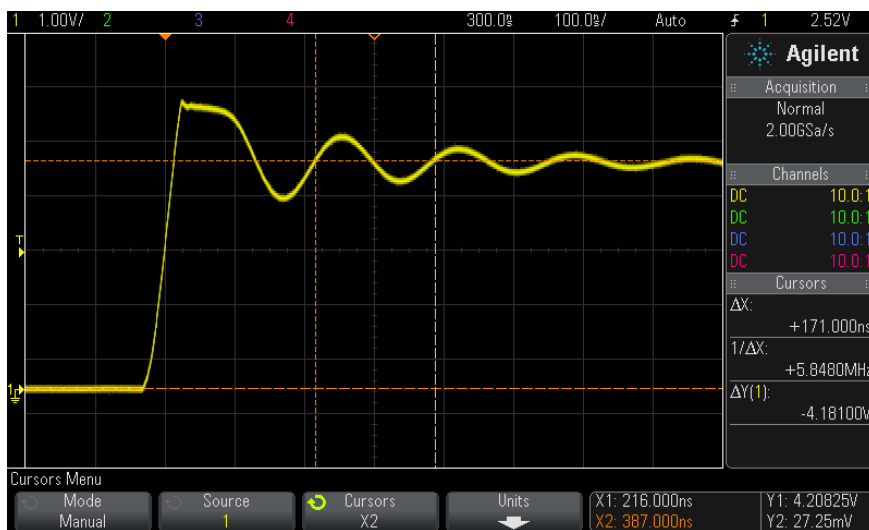

Figure 41 Cursors measure frequency of pulse ringing

Expand the display with Zoom mode, then characterize the event of interest with the cursors.

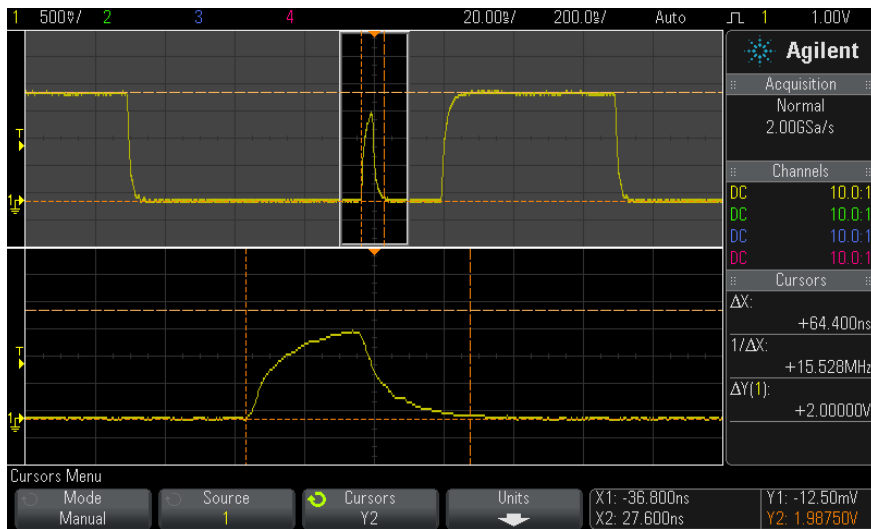

Figure 42 Cursors track Zoom window

Put the **X1** cursor on one side of a pulse and the **X2** cursor on the other side of the pulse.

13 Cursors

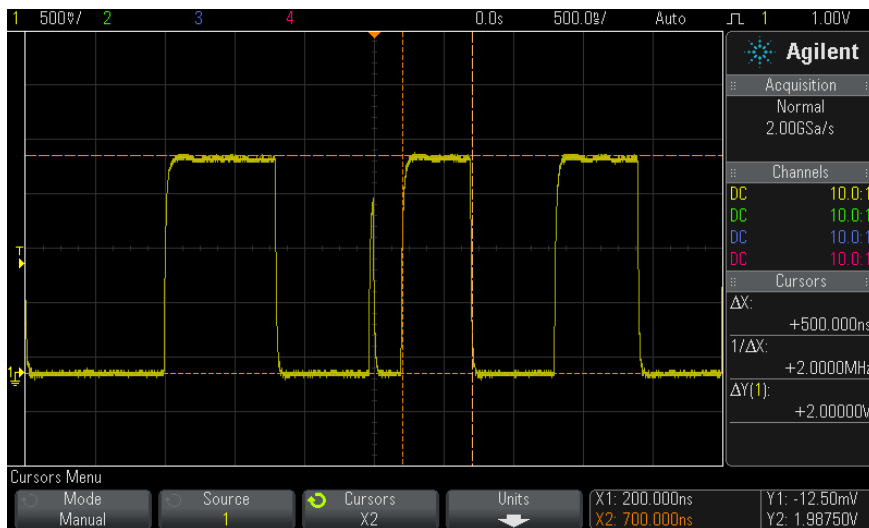

Figure 43 Measuring pulse width with cursors

Press the **X1 X2 linked** softkey and move the cursors together to check for pulse width variations in a pulse train.

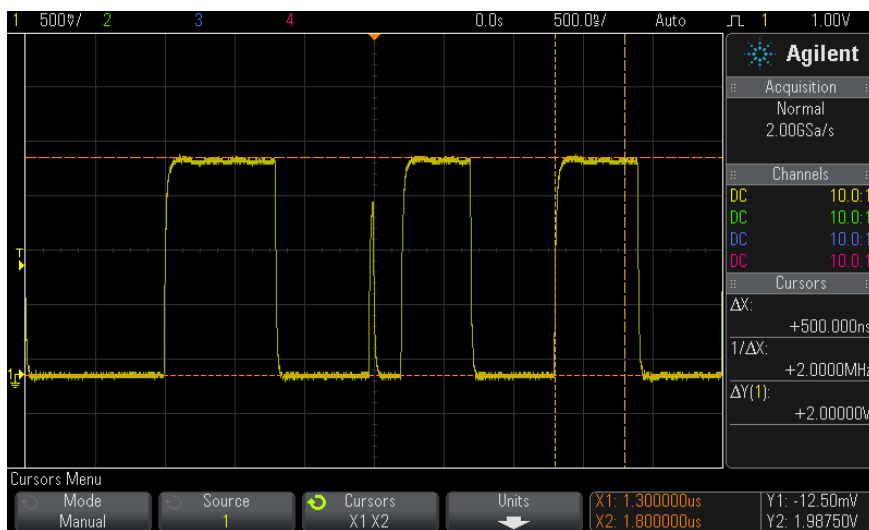
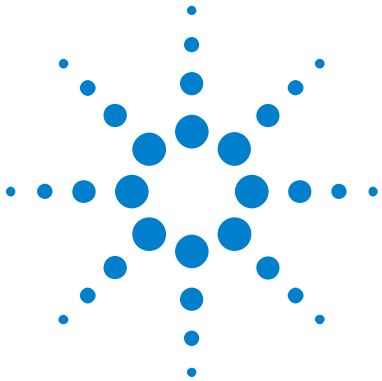

Figure 44 Moving the cursors together to check pulse width variations



14 Measurements

To make automatic measurements	216
Measurements Summary	217
Voltage Measurements	220
Time Measurements	227
Count Measurements	234
Mixed Measurements	235
Measurement Thresholds	236
Measurement Window with Zoom Display	238
Measurement Statistics	238

The **[Meas]** key lets you make automatic measurements on waveforms. Some measurements can only be made on analog input channels.

The results of the last four selected measurements are displayed in the Measurements information area on the right-hand side of the screen.

Cursors are turned on to show the portion of the waveform being measured for the most recently selected measurement (bottom-most on the right-side measurement area).

NOTE

Post Acquisition Processing

In addition to changing display parameters after the acquisition, you can perform all of the measurements and math functions after the acquisition. Measurements and math functions will be recalculated as you pan and zoom and turn channels on and off. As you zoom in and out on a signal using the horizontal scale knob and vertical volts/division knob, you affect the resolution of the display. Because measurements and math functions are performed on displayed data, you affect the resolution of functions and measurements.



To make automatic measurements

- 1 Press the **[Meas]** key to display the Measurement Menu.



- 2 Press the **Source** softkey to select the channel, running math function, or reference waveform to be measured.

Only channels, math functions, or reference waveforms that are displayed are available for measurements.

If a portion of the waveform required for a measurement is not displayed or does not display enough resolution to make the measurement, the result will display "No Edges", "Clipped", "Low Signal", "< value", or "> value", or a similar message to indicate that the measurement may not be reliable.

- 3 Press the **Type:** softkey; then, rotate the Entry knob to select a measurement to be made.

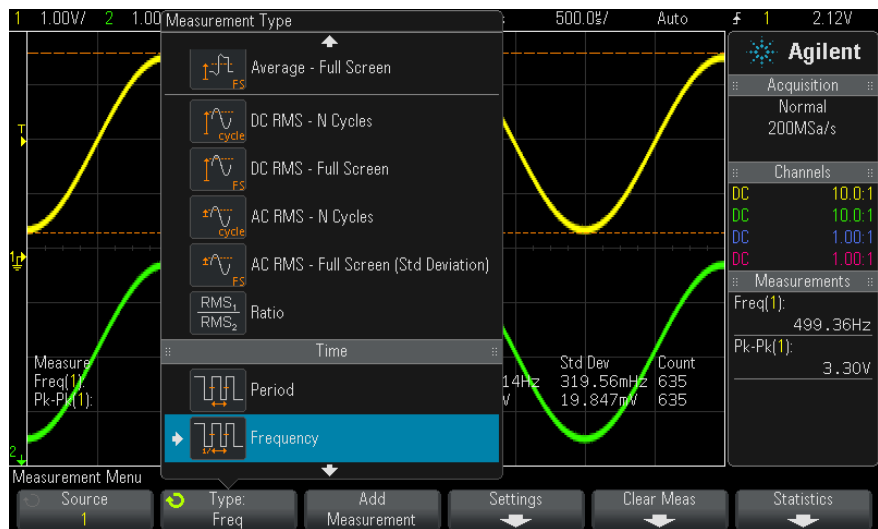

For more information on the types of measurements, see "[Measurements Summary](#)" on page 217.

- 4 The **Settings** softkey will be available to make additional measurement settings on some measurements.
- 5 Press the **Add Measurement** softkey or push the Entry knob to display the measurement.

Cursors are turned on to show the portion of the waveform being measured for the most recently added measurement (bottom-most on the display). To view the cursors for a previously added measurement (but not the last one), add the measurement again.

By default, measurement statistics are displayed. See "[Measurement Statistics](#)" on page 238.

- 6 To turn off measurements, press the [**Meas**] key again.

Measurements are erased from the display.

- 7 To stop making one or more measurements, press the **Clear Meas** softkey and choose the measurement to clear, or press **Clear All**.

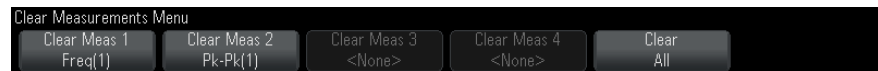

After all measurements have been cleared, when [**Meas**] is pressed again, the default measurements will be Frequency and Peak-Peak.

Measurements Summary

The automatic measurements provided by the oscilloscope are listed in the following table. All measurements are available for analog channel waveforms. All measurements except Counter are available for reference waveforms and math waveforms other than FFT. A limited set of measurements is available for math FFT waveforms and for digital channel waveforms (as described in the following table).

14 Measurements

Measurement	Valid for Math FFT	Valid for Digital Channels	Notes
"Snapshot All" on page 219			
"Amplitude" on page 221			
"Area" on page 235			
"Average" on page 224	Yes, Full Screen		
"Base" on page 222			
"Burst Width" on page 230			
"Counter" on page 229		Yes	Not valid for math waveforms.
"Delay" on page 231			Measures between two sources. Press Settings to specify the second source.
"Duty Cycle" on page 230		Yes	
"Fall Time" on page 231			
"Frequency" on page 228		Yes	
"Maximum" on page 221	Yes		
"Minimum" on page 221	Yes		
"Rising Edge Count" on page 235			
"Falling Edges Count" on page 235			
"Positive Pulse Count" on page 234			
"Negative Pulse Count" on page 235			
"Overshoot" on page 223			
"Peak-Peak" on page 221	Yes		
"Period" on page 228		Yes	

Measurement	Valid for Math FFT*	Valid for Digital Channels	Notes
"Phase" on page 232			Measures between two sources. Press Settings to specify the second source.
"Preshoot" on page 224			
"Ratio" on page 227			Measures between two sources. Press Settings to specify the second source.
"Rise Time" on page 231			
"DC RMS" on page 225			
"AC RMS" on page 225			
"Top" on page 221			
"+ Width" on page 230		Yes	
"- Width" on page 230		Yes	
"X at Max Y" on page 234	Yes		The resultant units are in Hertz.
"X at Min Y" on page 233	Yes		The resultant units are in Hertz.
* Use the cursors to make other measurements on FFT.			

Note that additional Power App measurements are available when the DSOX3PWR power measurement and analysis license is installed and the Power Application is enabled. For more information, see the *DSOX3PWR Power Measurement Application User's Guide* at ["www.agilent.com/find/3000X-Series-manual"](http://www.agilent.com/find/3000X-Series-manual) or on the Documentation CD.

Snapshot All

The Snapshot All measurement type displays a popup containing a snapshot of all the single waveform measurements.



You can also configure the **[Quick Action]** key to display the Snapshot All popup. See ["Configuring the \[Quick Action\] Key"](#) on page 311.

Voltage Measurements

The following figure shows the voltage measurement points.

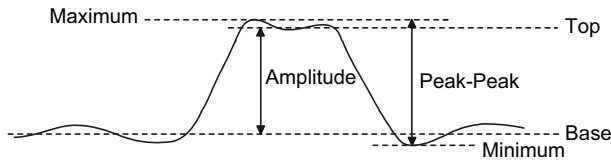

Measurement units for each input channel can be set to Volts or Amps using the channel **Probe Units** softkey. See ["To specify the channel units"](#) on page 69.

The units of math waveforms are described in ["Units for Math Waveforms"](#) on page 76.

- ["Peak-Peak"](#) on page 221

- "Maximum" on page 221
- "Minimum" on page 221
- "Amplitude" on page 221
- "Top" on page 221
- "Base" on page 222
- "Overshoot" on page 223
- "Preshoot" on page 224
- "Average" on page 224
- "DC RMS" on page 225
- "AC RMS" on page 225
- "Ratio" on page 227

Peak-Peak

The peak-to-peak value is the difference between Maximum and Minimum values. The Y cursors show the values being measured.

Maximum

Maximum is the highest value in the waveform display. The Y cursor shows the value being measured.

Minimum

Minimum is the lowest value in the waveform display. The Y cursor shows the value being measured.

Amplitude

The Amplitude of a waveform is the difference between its Top and Base values. The Y cursors show the values being measured.

Top

The Top of a waveform is the mode (most common value) of the upper part of the waveform, or if the mode is not well defined, the top is the same as Maximum. The Y cursor shows the value being measured.

14 Measurements

See Also • ["To isolate a pulse for Top measurement"](#) on page 222

To isolate a pulse for Top measurement

The following figure shows how to use Zoom mode to isolate a pulse for a **Top** measurement.

You may need to change the measurement window setting so that the measurement is made in the lower, Zoom window. See ["Measurement Window with Zoom Display"](#) on page 238.



Figure 45 Isolating area for Top measurement

Base

The Base of a waveform is the mode (most common value) of the lower part of the waveform, or if the mode is not well defined, the base is the same as Minimum. The Y cursor shows the value being measured.

Overshoot

Overshoot is distortion that follows a major edge transition expressed as a percentage of Amplitude. The X cursors show which edge is being measured (edge closest to the trigger reference point).

$$\text{Rising edge overshoot} = \frac{\text{local Maximum} - \text{D Top}}{\text{Amplitude}} \times 100$$

$$\text{Falling edge overshoot} = \frac{\text{Base} - \text{D local Minimum}}{\text{Amplitude}} \times 100$$

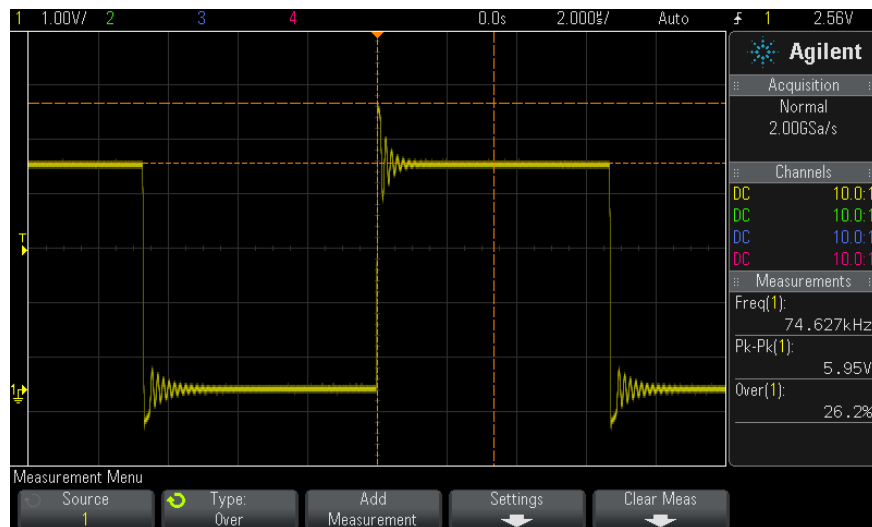
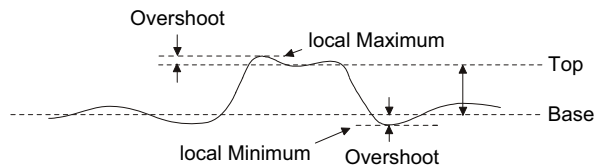

Figure 46 Automatic Overshoot measurement

Preshoot

Preshoot is distortion that precedes a major edge transition expressed as a percentage of Amplitude. The X cursors show which edge is being measured (edge closest to the trigger reference point).

$$\text{Rising edge preshoot} = \frac{\text{local Maximum} - \text{D Top}}{\text{Amplitude}} \times 100$$

$$\text{Falling edge preshoot} = \frac{\text{Base} - \text{D local Minimum}}{\text{Amplitude}} \times 100$$

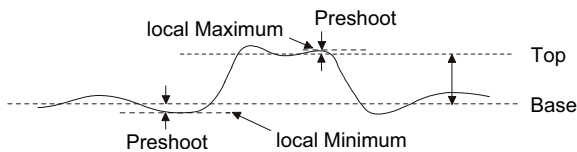

Average

Average is the sum of the levels of the waveform samples divided by the number of samples.

$$\text{Average} = \frac{\sum x_i}{n}$$

Where x_i = value at i th point being measured, n = number of points in measurement interval.

The Full Screen measurement interval variation measures the value on all displayed data points.

The N Cycles measurement interval variation measures the value on an integral number of periods of the displayed signal. If less than three edges are present, the measurement shows "No edges".

The X cursors show what interval of the waveform is being measured.

DC RMS

DC RMS is the root-mean-square value of the waveform over one or more full periods.

$$\text{RMS (dc)} = \sqrt{\frac{\sum_{i=1}^n x_i^2}{n}}$$

Where x_i = value at i th point being measured, n = number of points in measurement interval.

The Full Screen measurement interval variation measures the value on all displayed data points.

The N Cycles measurement interval variation measures the value on an integral number of periods of the displayed signal. If less than three edges are present, the measurement shows "No edges".

The X cursors show the interval of the waveform being measured.

AC RMS

AC RMS is the root-mean-square value of the waveform, with the DC component removed. It is useful, for example, for measuring power supply noise.

The N Cycles measurement interval measures the value on an integral number of periods of the displayed signal. If less than three edges are present, the measurement shows "No edges".

The X cursors show the interval of the waveform being measured.

The Full Screen (Std Deviation) measurement interval variation is an RMS measurement across the full screen with the DC component removed. It shows the standard deviation of the displayed voltage values.

The standard deviation of a measurement is the amount that a measurement varies from the mean value. The Mean value of a measurement is the statistical average of the measurement.

14 Measurements

The following figure graphically shows the mean and standard deviation. Standard deviation is represented by the Greek letter sigma: σ . For a Gaussian distribution, two sigma ($\pm 1\sigma$) from the mean, is where 68.3 percent of the measurement results reside. Six sigma ($\pm 3\sigma$) from is where 99.7 percent of the measurement results reside.

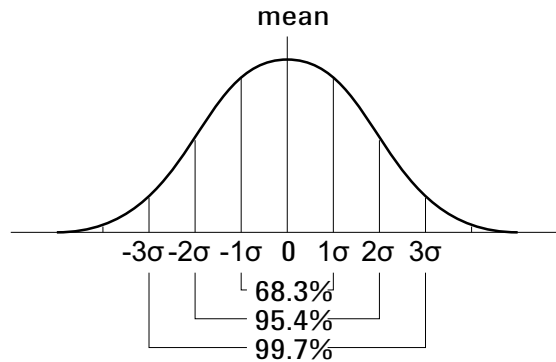

The mean is calculated as follows:

$$\bar{x} = \frac{\sum_{i=1}^N x_i}{N}$$

where:

- \bar{x} = the mean.
- N = the number of measurements taken.
- x_i = the i th measurement result.

The standard deviation is calculated as follows:

$$\sigma = \sqrt{\frac{\sum_{i=1}^N (x_i - \bar{x})^2}{N}}$$

where:

- σ = the standard deviation.
- N = the number of measurements taken.

- x_i = the i th measurement result.
- \bar{x} = the mean.

Ratio

The Ratio measurement displays the ratio of the AC RMS voltages of two sources, expressed in dB. Press the **Settings** softkey to select the source channels for the measurement.

Time Measurements

The following figure shows time measurement points.

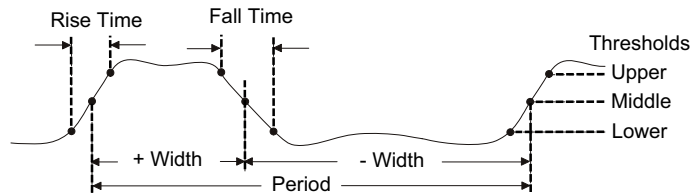

The default lower, middle, and upper measurement thresholds are 10%, 50%, and 90% between Top and Base values. See ["Measurement Thresholds"](#) on page 236 for other percentage threshold and absolute value threshold settings.

- ["Period"](#) on page 228
- ["Frequency"](#) on page 228
- ["Counter"](#) on page 229
- ["+ Width"](#) on page 230
- ["- Width"](#) on page 230
- ["Burst Width"](#) on page 230
- ["Duty Cycle"](#) on page 230
- ["Rise Time"](#) on page 231
- ["Fall Time"](#) on page 231
- ["Delay"](#) on page 231

- ["Phase"](#) on page 232
- ["X at Min Y"](#) on page 233
- ["X at Max Y"](#) on page 234

Period

Period is the time period of the complete waveform cycle. The time is measured between the middle threshold points of two consecutive, like-polarity edges. A middle threshold crossing must also travel through the lower and upper threshold levels which eliminates runt pulses. The X cursors show what portion of the waveform is being measured. The Y cursor shows the middle threshold point.

Frequency

Frequency is defined as $1/\text{Period}$. Period is defined as the time between the middle threshold crossings of two consecutive, like-polarity edges. A middle threshold crossing must also travel through the lower and upper threshold levels which eliminates runt pulses. The X cursors show what portion of the waveform is being measured. The Y cursor shows the middle threshold point.

See Also • ["To isolate an event for frequency measurement"](#) on page 228

To isolate an event for frequency measurement

The following figure shows how to use Zoom mode to isolate an event for a frequency measurement.

You may need to change the measurement window setting so that the measurement is made in the lower, Zoom window. See ["Measurement Window with Zoom Display"](#) on page 238.

If the waveform is clipped, it may not be possible to make the measurement.

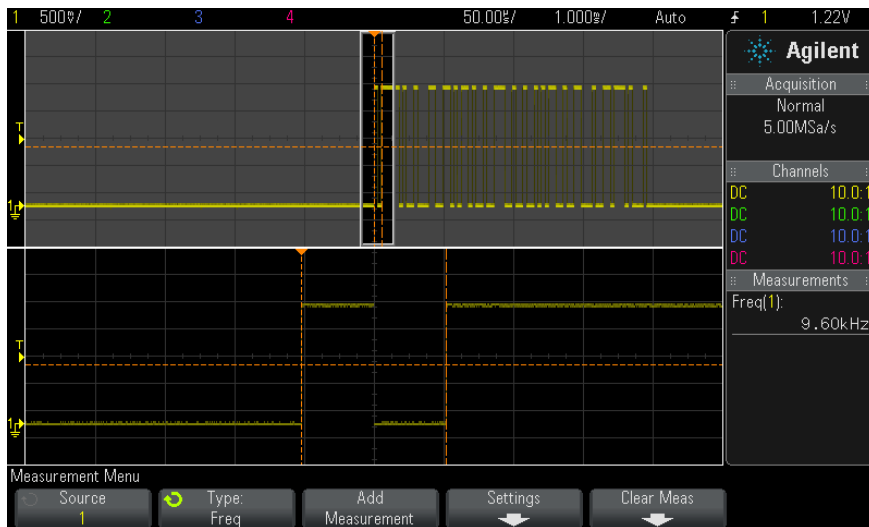

Figure 47 Isolating an event for Frequency measurement

Counter

The InfiniiVision 3000 X-Series oscilloscopes have an integrated hardware frequency counter which counts the number of cycles that occur within a period of time (known as the gate time) to measure the frequency of a signal.

The gate time for the Counter measurement is automatically adjusted to be 100 ms or twice the current time window, whichever is longer, up to 1 second.

The Counter can measure frequencies up to the bandwidth of the oscilloscope. The minimum frequency supported is $1/(2 \times \text{gate time})$.

The hardware counter uses the trigger comparator output. Therefore, the counted channel's trigger level (or threshold for digital channels) must be set correctly. The Y cursor shows the threshold level used in the measurement.

Analog and digital channels can be selected as the source.

Only one Counter measurement can be displayed at a time.

+ Width

+ **Width** is the time from the middle threshold of the rising edge to the middle threshold of the next falling edge. The X cursors show the pulse being measured. The Y cursor shows the middle threshold point.

– Width

– **Width** is the time from the middle threshold of the falling edge to the middle threshold of the next rising edge. The X cursors show the pulse being measured. The Y cursor shows the middle threshold point.

Burst Width

The Burst Width measurement is the time from the first edge to the last edge on screen.

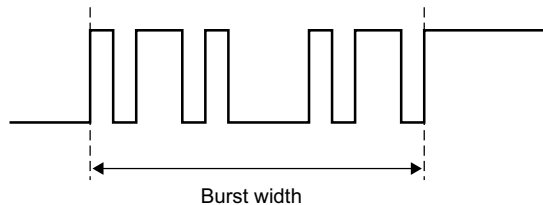

Duty Cycle

The duty cycle of a repetitive pulse train is the ratio of the positive pulse width to the period, expressed as a percentage. The X cursors show the time period being measured. The Y cursor shows the middle threshold point.

$$\text{Duty cycle} = \frac{+ \text{Width}}{\text{Period}} \times 100$$

Rise Time

The rise time of a signal is the time difference between the crossing of the lower threshold and the crossing of the upper threshold for a positive-going edge. The X cursor shows the edge being measured. For maximum measurement accuracy, set the horizontal time/div as fast as possible while leaving the complete rising edge of the waveform on the display. The Y cursors show the lower and upper threshold points.

Fall Time

The fall time of a signal is the time difference between the crossing of the upper threshold and the crossing of the lower threshold for a negative-going edge. The X cursor shows the edge being measured. For maximum measurement accuracy, set the horizontal time/div as fast as possible while leaving the complete falling edge of the waveform on the display. The Y cursors show the lower and upper threshold points.

Delay

Delay measures the time difference from the selected edge on source 1 and the selected edge on source 2 closest to the trigger reference point at the middle threshold points on the waveforms. Negative delay values indicate that the selected edge of source 1 occurred after the selected edge of source 2.

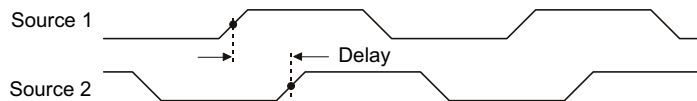

- 1 Press the **[Meas]** key to display the Measurement Menu.
- 2 Press the **Source** softkey; then turn the Entry knob to select the first analog channel source.
- 3 Press the **Type:** softkey; then, turn the Entry knob to select **Delay**.
- 4 Press the **Settings** softkey to select the second analog channel source and slope for the delay measurement.

The default Delay settings measure from the rising edge of channel 1 to the rising edge of channel 2.

14 Measurements

- 5 Press the  Back/Up key to return to the Measurement Menu.
- 6 Press the **Add Measurement** softkey to make the measurement.

The example below shows a delay measurement between the rising edge of channel 1 and the rising edge of channel 2.

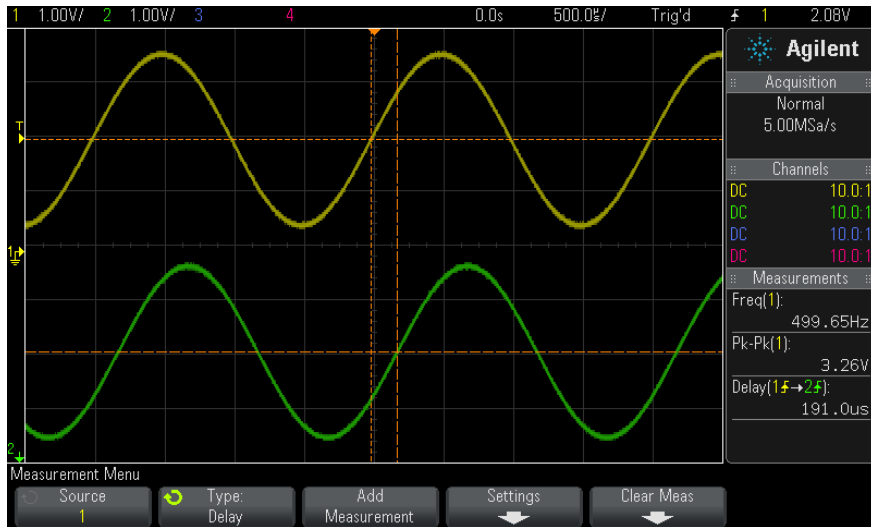

Phase

Phase is the calculated phase shift from source 1 to source 2, expressed in degrees. Negative phase shift values indicate that the rising edge of source 1 occurred after the rising edge of source 2.

$$\text{Phase} = \frac{\text{Delay}}{\text{Source 1 Period}} \times 360$$

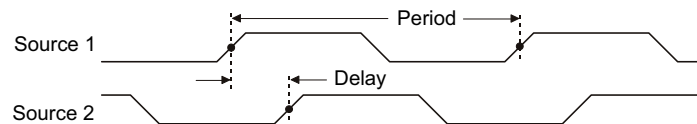

- 1 Press the **[Meas]** key to display the Measurement Menu.
- 2 Press the **Source** softkey; then turn the Entry knob to select the first analog channel source.
- 3 Press the **Type:** softkey; then, turn the Entry knob to select **Delay**.
- 4 Press the **Settings** softkey to select the second analog channel source for the phase measurement.

The default Phase settings measure from channel 1 to channel 2.

- 5 Press the  Back/Up key to return to the Measurement Menu.
- 6 Press the **Add Measurement** softkey to make the measurement.

The example below shows a phase measurement between the channel 1 and the math d/dt function on channel 1.

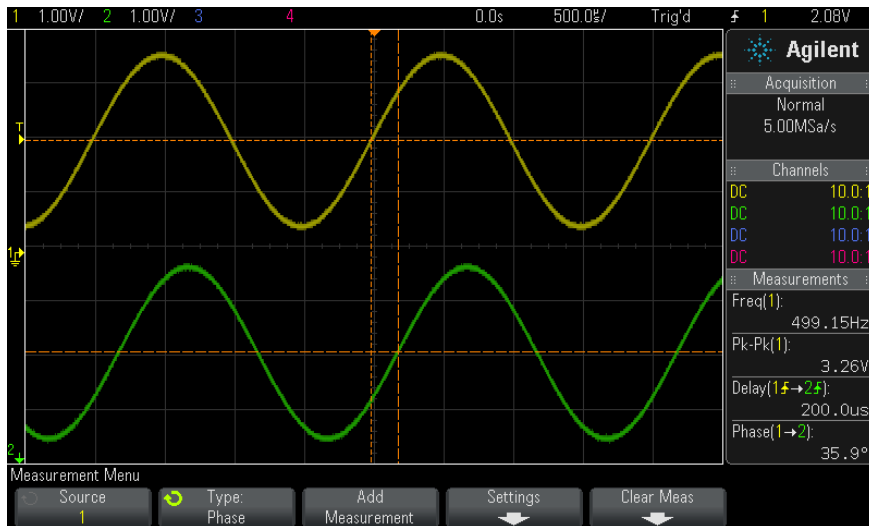

X at Min Y

X at Min Y is the X axis value (usually time) at the first displayed occurrence of the waveform Minimum, starting from the left-side of the display. For periodic signals, the position of the minimum may vary throughout the waveform. The X cursor shows where the current X at Min Y value is being measured.

X at Max Y

X at Max Y is the X axis value (usually time) at the first displayed occurrence of the waveform Maximum, starting from the left-side of the display. For periodic signals, the position of the maximum may vary throughout the waveform. The X cursor shows where the current X at Max Y value is being measured.

See Also • ["To measure the peak of an FFT"](#) on page 234

To measure the peak of an FFT

- 1 Select **FFT** as the Operator in the Waveform Math Menu.
- 2 Choose **Math: f(t)** as the source in the Measurement Menu.
- 3 Choose **Maximum** and **X at Max Y** measurements.

Maximum units are in dB and **X at Max Y** units are in Hertz for FFT.

Count Measurements

- ["Positive Pulse Count"](#) on page 234
- ["Negative Pulse Count"](#) on page 235
- ["Rising Edge Count"](#) on page 235
- ["Falling Edges Count"](#) on page 235

Positive Pulse Count

The **Positive Pulse Count** measurement is a pulse count for the selected waveform source.

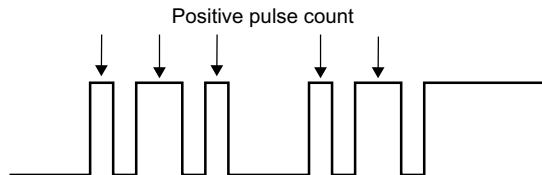

This measurement is available for analog channels.

Negative Pulse Count

The **Negative Pulse Count** measurement is a pulse count for the selected waveform source.

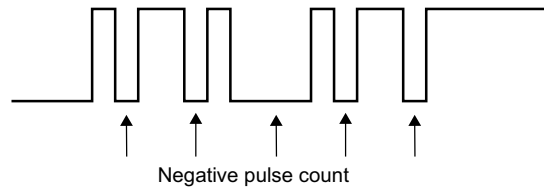

This measurement is available for analog channels.

Rising Edge Count

The **Rising Edge Count** measurement is an edge count for the selected waveform source.

This measurement is available for analog channels.

Falling Edges Count

The **Falling Edges Count** measurement is an edge count for the selected waveform source.

This measurement is available for analog channels.

Mixed Measurements

- ["Area"](#) on page 235

Area

Area measures the area between the waveform and the ground level. Area below the ground level is subtracted from area above the ground level.

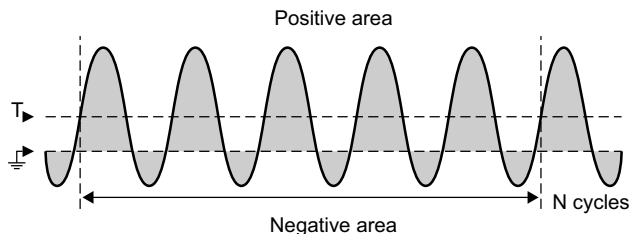

The Full Screen measurement interval variation measures the value on all displayed data points.

The N Cycles measurement interval variation measures the value on an integral number of periods of the displayed signal. If less than three edges are present, the measurement shows "No edges".

The X cursors show what interval of the waveform is being measured.

Measurement Thresholds

Setting measurement thresholds defines the vertical levels where measurements will be taken on an analog channel or math waveform.

NOTE

Changing default thresholds may change measurement results

The default lower, middle, and upper threshold values are 10%, 50%, and 90% of the value between Top and Base. Changing these threshold definitions from the default values may change the returned measurement results for Average, Delay, Duty Cycle, Fall Time, Frequency, Overshoot, Period, Phase, Preshoot, Rise Time, +Width, and -Width.

- 1 From the Measurement Menu, press the **Settings** softkey; then, press the **Thresholds** softkey to set analog channel measurement thresholds.

You can also open the Measurement Threshold Menu by pressing **[Analyze] > Features** and then selecting **Measurement Thresholds**.

- 2 Press the **Source** softkey to select the analog channel or math waveform source for which you want to change measurement thresholds.

Each analog channel and the math waveform can be assigned unique threshold values.



- 3 Press the **Type** softkey to set the measurement threshold to **%** (percentage of Top and Base value) or to **Absolute** (absolute value).
 - Percentage thresholds can be set from 5% to 95%.
 - The units for absolute threshold for each channel is set in the channel probe menu.
 - When the **Source** is set to **Math: f(t)**, the threshold **Type** can only be set to **Percent**.

TIP

Absolute threshold hints

- Absolute thresholds are dependent on channel scaling, probe attenuation, and probe units. Always set these values first before setting absolute thresholds.
- The minimum and maximum threshold values are limited to on-screen values.
- If any of the absolute threshold values are above or below the minimum or maximum waveform values, the measurement may not be valid.

- 4 Press the **Lower** softkey; then, turn the Entry knob to set the lower measurement threshold value.

Increasing the lower value beyond the set middle value will automatically increase the middle value to be more than the lower value. The default lower threshold is 10% or 800 mV.

If threshold **Type** is set to **%**, the lower threshold value can be set from 5% to 93%.

- 5 Press the **Middle** softkey; then, turn the Entry knob to set the middle measurement threshold value.

The middle value is bounded by the values set for lower and upper thresholds. The default middle threshold is 50% or 1.20 V.

- If threshold **Type** is set to **%**, the middle threshold value can be set from 6% to 94%.

- 6 Press the **Upper** softkey; then, turn the Entry knob to set the upper measurement threshold value.

Decreasing the upper value below the set middle value will automatically decrease the middle value to be less than the upper value. The default upper threshold is 90% or 1.50 V.

- If threshold **Type** is set to %, the upper threshold value can be set from 7% to 95%.

Measurement Window with Zoom Display

When the zoomed time base is displayed, you can choose whether measurements are made in the Main window portion of the display or the Zoom window portion of the display.

- 1 Press the [**Meas**] key.
- 2 In the Measurement Menu, press the **Settings** softkey.
- 3 In the Measurement Settings Menu, press the **Meas Window** softkey; then, turn the Entry knob to select from:
 - **Auto Select** – The measurement is attempted in the lower, Zoom window; if it cannot be made there, the upper, Main window is used.
 - **Main** – The measurement window is the upper, Main window.
 - **Zoom** – The measurement window is the lower, Zoom window.

Measurement Statistics

Press the [**Meas**] key to enter the Measurement Menu. By default, statistics are displayed, and frequency and voltage are measured on channel 1.

Select the measurements you desire for the channels you are using (see "[Measurements Summary](#)" on page 217).

From the Measurement Menu, press the **Statistics** softkey to enter the Statistics Menu.

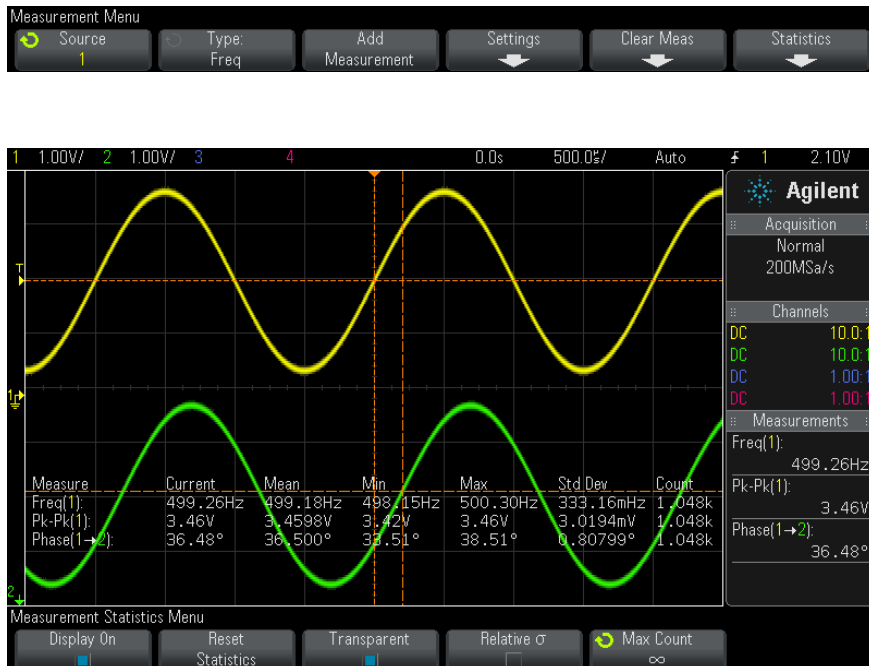

The following statistics are shown: Name of the measurement, current measured value, mean, minimum measured value, maximum measured value, standard deviation, and the number of times the measurement has been made (count). Statistics are based on the total number of captured waveforms (count).

The standard deviation shown in Statistics is calculated using the same formula used for calculating the standard deviation measurement. The formula is shown in the section titled "[AC RMS](#)" on page 225.

The source channel of the measurement is shown in parenthesis after the measurement name. For example: "**Freq(1)**" indicates a frequency measurement on channel 1.

You can switch the statistics **Display On** or **Display Off**. Statistics continue to accumulate even when the statistics display is off.

When you navigate away from the Measurements Menu, the statistics display will no longer be displayed, but statistical data collection will continue. Return to the Measurements Menu to see the data again.

To reset the statistics measurements, press the **Reset Statistics** softkey. This resets all statistics and begins recording statistical data again.

Each time a new measurement (for example: frequency, period, or amplitude) is added the statistics are reset and accumulation of statistical data begins again.

When the **[Single]** key is pressed, statistics are reset and a single measurement is done (count = 1). Successive **[Single]** acquisitions accumulate statistical data (and the count is incremented).

Press the **Transparent** softkey to disable the Transparent mode. This shows statistics with a gray background. Press the **Transparent** softkey again to enable Transparent mode. This writes measurement values, statistics, and cursor values on the screen without a background. The Transparent setting affects measurement statistics, reference waveform information, and the optional Mask test feature's statistics display.

Relative σ – When enabled, the standard deviation shown in measurement statistics becomes a relative standard deviation, that is, standard deviation/mean.

Max Count – This softkey specifies the number of values used when calculating measurement statistics.

The **Increment Statistics** softkey only appears when the acquisition is stopped and the optional segmented memory feature is off. Press the **[Single]** or **[Run/Stop]** key to stop the acquisition. You can use the horizontal position control (in the Horizontal control section of the front panel) to pan through the waveform. Active measurements will stay on screen, allowing you to measure various aspects of the captured waveforms. Press **Increment Statistics** to add the currently measured waveform to the collected statistical data.

The **Analyze Segments** softkey only appears when the acquisition is stopped and the optional segmented memory feature is on. After an acquisition has completed (and the oscilloscope is stopped), you can press the **Analyze Segments** softkey to accumulate measurement statistics for the acquired segments.

You can also turn on infinite persistence (in the Display Menu) and press the **Analyze Segments** softkey to create an infinite persistence display.



15 Mask Testing

- To create a mask from a "golden" waveform (Automask) [241](#)
- Mask Test Setup Options [243](#)
- Mask Statistics [246](#)
- To manually modify a mask file [247](#)
- Building a Mask File [250](#)

One way to verify a waveform's compliance to a particular set of parameters is to use mask testing. A mask defines a region of the oscilloscope's display in which the waveform must remain in order to comply with chosen parameters. Compliance to the mask is verified point-by-point across the display. Mask test operates on displayed analog channels; it does not operate on channels that are not displayed.

To enable mask test order Option LMT at time of oscilloscope purchase, or order DSOX3MASK as a stand-alone item after oscilloscope purchase.

To create a mask from a "golden" waveform (Automask)

A golden waveform meets all chosen parameters, and it is the waveform to which all others will be compared.

- 1 Configure the oscilloscope to display the golden waveform.
- 2 Press the **[Analyze]** key.
- 3 Press **Features**; then, select **Mask Test**.
- 4 Press **Features** again to enable mask testing.



15 Mask Testing

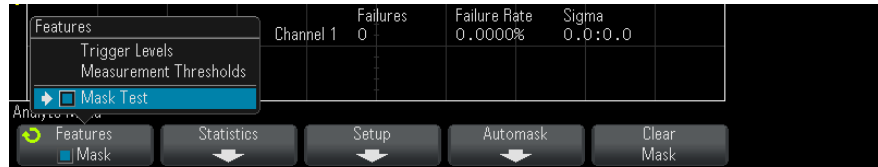

5 Press **Automask**.

6 In the Automask Menu, press the **Source** softkey and ensure the desired analog channel is selected.





7 Adjust the mask's horizontal tolerance ($\pm Y$) and vertical tolerance ($\pm X$). These are adjustable in graticule divisions or in absolute units (volts or seconds), selectable using the **Units** softkey.

8 Press the **Create Mask** softkey.

The mask is created and testing begins.

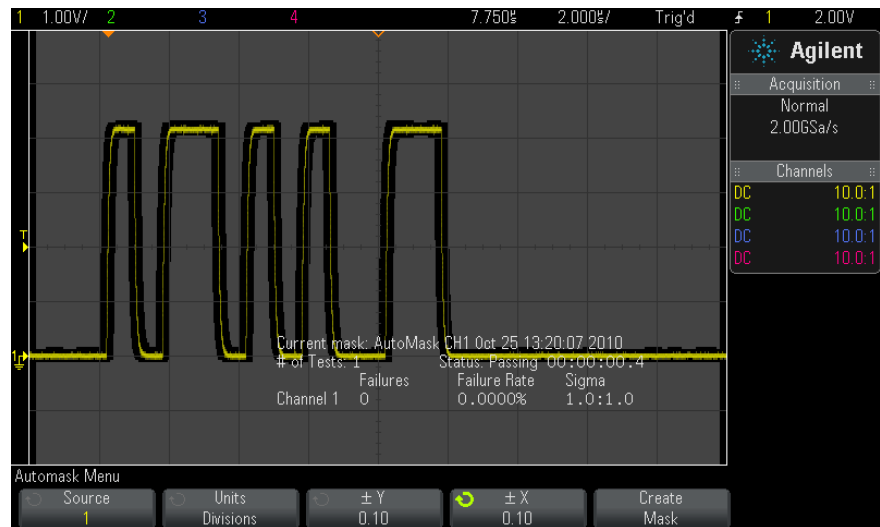
Whenever the **Create Mask** softkey is pressed the old mask is erased and a new mask is created.



- 9 To clear the mask and switch off mask testing, press the  Back/Up key to return to the Mask Test Menu, then press the **Clear Mask** softkey.

If infinite persistence display mode (see "To set or clear persistence" on page 133) is "on" when mask test is enabled, it stays on. If infinite persistence is "off" when mask test is enabled, it is switched on when mask test is switched on, then infinite persistence is switched off when mask test is switched off.

Troubleshooting Mask Setup

If you press **Create Mask** and the mask appears to cover the entire screen, check the $\pm Y$ and $\pm X$ settings in the Automask Menu. If these are set to zero the resulting mask will be extremely tight around the waveform.

If you press **Create Mask** and it appears that no mask was created, check the $\pm Y$ and $\pm X$ settings. They may be set so large that the mask is not visible.

Mask Test Setup Options

From the Mask Test Menu, press the **Setup** softkey to enter the Mask Setup Menu.

Run Until	<p>The Run Until softkey lets you specify a condition on which to terminate testing.</p> <ul style="list-style-type: none"> • Forever — The oscilloscope runs continuously. However, if an error occurs the action specified using the On Error softkey will occur. • Minimum # of Tests — Choose this option and then use the # of Tests softkey to select the number of times the oscilloscope will trigger, display the waveform(s), and compare them to the mask. The oscilloscope will stop after the specified number of tests have been completed. The specified minimum number of tests may be exceeded. If an error occurs the action specified using the On Error softkey will occur. The actual number of tests completed is displayed above the softkeys. • Minimum Time — Choose this option and then use the Test Time softkey to select how long the oscilloscope will run. When the selected time has passed the oscilloscope will stop. The specified time may be exceeded. If an error occurs the action specified using the On Error softkey will occur. The actual test time is displayed above the softkeys. • Minimum Sigma — Choose this option and then use the Sigma softkey to select a minimum sigma. The mask test runs until enough waveforms are tested to achieve a minimum test sigma. (If an error occurs the oscilloscope will perform the action specified by the On Error softkey.) Note that this is a test sigma (the max achievable process sigma, assuming no defects, for a certain number of tested waveforms) as opposed to a process sigma (which is tied to the amount of failures per test). The sigma value may exceed the selected value when a small sigma value is chosen. The actual sigma is displayed.
------------------	---

On Error	<p>The On Error setting specifies the action(s) to take when the input waveform does not conform to the mask. This setting supersedes the Run Until setting.</p> <ul style="list-style-type: none"> • Stop — The oscilloscope will stop when the first error is detected (on the first waveform that does not conform to the mask). This setting supersedes the Minimum # of Tests and Minimum Time settings. • Save — The oscilloscope saves the screen image when an error is detected. In the Save Menu (press [Save/Recall] > Save), select an image format (*.bmp or *.png), destination (on a USB storage device), and file name (which can be auto-incrementing). If errors occur too frequently and the oscilloscope spends all its time saving images, press the [Stop] key to stop acquisitions. • Print — The oscilloscope prints the screen image when an error is detected. This option is only available when a printer is connected as described in "To print the oscilloscope's display" on page 289. • Measure — Measurements (and measurement statistics if your oscilloscope supports them) run only on waveforms that contain a mask violation. Measurements are not affected by passing waveforms. This mode is not available when the acquisition mode is set to Averaging. <p>Note that you can choose to Print or Save, but you cannot select both at the same time. All other actions may be selected at the same time. For example, you can select both Stop and Measure to cause the oscilloscope to measure and stop on the first error..</p> <p>You can also output a signal on the rear panel TRIG OUT BNC connector when there is a mask test failure. See "Setting the Rear Panel TRIG OUT Source" on page 304.</p>
Source Lock	<p>When you turn on Source Lock using the Source Lock softkey, the mask is redrawn to match the source whenever you move the waveform. For example, if you change the horizontal timebase or the vertical gain the mask is redrawn with the new settings.</p> <p>When you turn off Source Lock, the mask is not redrawn when horizontal or vertical settings are changed.</p>
Source	<p>If you change the Source channel, the mask is not erased. It is re-scaled to the vertical gain and offset settings of the channel to which it is assigned. To create a new mask for the selected source channel, go back up in the menu hierarchy; then, press Automask, and press Create Mask.</p> <p>The Source softkey in the Mask Setup Menu is the same as the Source softkey in the Automask Menu.</p>
Test All	<p>When enabled, all displayed analog channels are included in the mask test. When disabled, just the selected source channel is included in the test.</p>

Mask Statistics

From the Mask Test Menu, press the **Statistics** softkey to enter the Mask Statistics Menu.

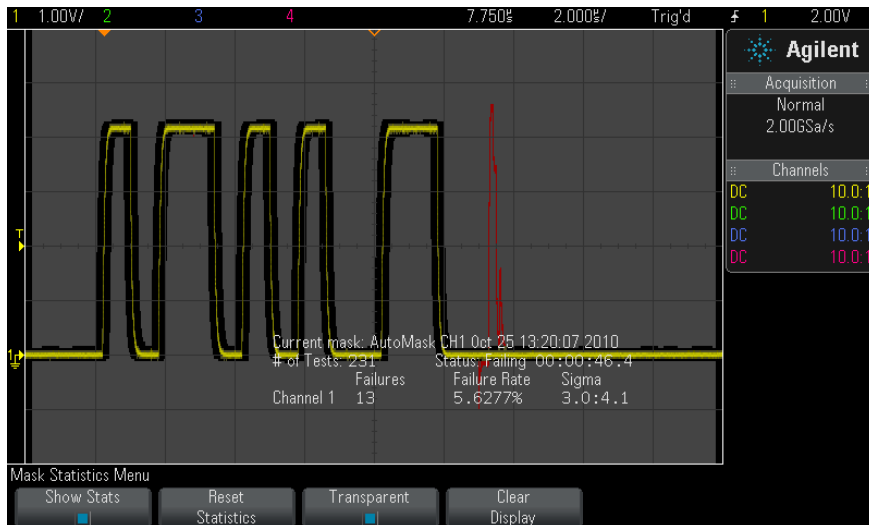

Show Stats

When you enable **Show Statistics** the following information is displayed:

- Current mask, name of mask, Channel number, date and time.
- # of Tests (total number of mask tests executed).
- Status (Passing, Failing, or Untested).
- Accumulated test time (in hours, minutes, seconds, and tenths of seconds).

And for each analog channel:

- Number of failures (acquisitions in which the signal excursion went beyond the mask).
- Failure rate (percentage of failures).
- Sigma (the ratio of process sigma to maximum achievable sigma, based on number of waveforms tested).

Reset Statistics	Note that statistics are also reset when: <ul style="list-style-type: none"> • Mask Test is switched on after being switched off. • Clear Mask softkey is pressed. • An Automask is created. Additionally, the accumulated time counter is reset whenever the oscilloscope is run after the acquisition was stopped.
Transparent	Enable Transparent mode to write measurement values and statistics on the screen without a background. Disable the Transparent mode to show them with a gray background. The Transparent setting affects mask test statistics, measurement statistics, and reference waveform information display.
Clear Display	Clears acquisition data from the oscilloscope display.

To manually modify a mask file

You can manually modify a mask file that you created using the Automask function.

- 1 Follow the steps 1-7 in "[To create a mask from a "golden" waveform \(Automask\)](#)" on page 241. Do not clear the mask after creating it.
- 2 Attach a USB mass storage device to the oscilloscope.
- 3 Press the **[Save/Recall]** key.
- 4 Press the **Save** softkey.
- 5 Press the **Format** softkey and select **Mask**.
- 6 Press the second softkey and select a destination folder on your USB mass storage device.
- 7 Press the **Press to Save** softkey. This creates an ASCII text file that describes the mask.
- 8 Remove the USB mass storage device and connect it to a PC.
- 9 Open the .msk file your created using a text editor (such as Wordpad).
- 10 Edit, save, and close the file.

The mask file contains the following sections:

- Mask File Identifier.
- Mask Title.
- Mask Violation Regions.

15 Mask Testing

- Oscilloscope Setup Information.

Mask File Identifier The Mask File Identifier is MASK_FILE_548XX.

Mask Title The Mask Title is a string of ASCII characters. Example: autoMask CH1
OCT 03 09:40:26 2008

When a mask file contains the keyword "autoMask" in the title, the edge of the mask is passing by definition. Otherwise, the edge of the mask is defined as a failure.

Mask Violation Regions

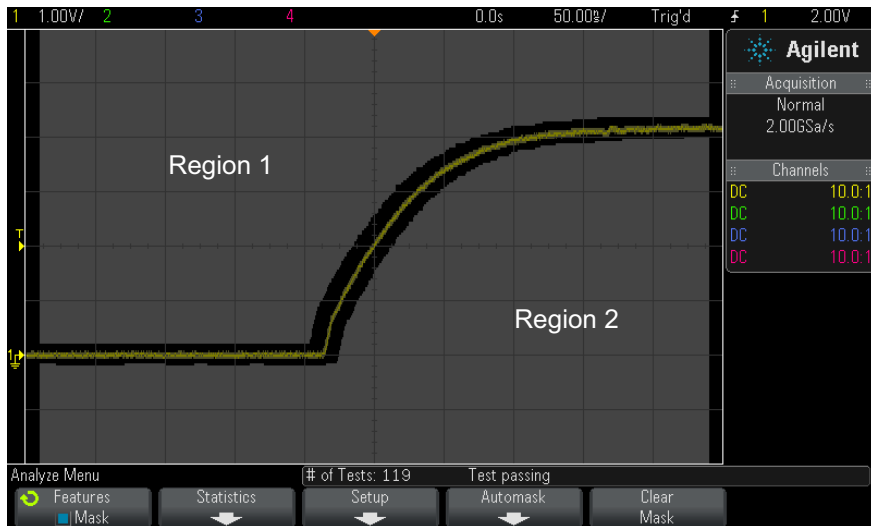

Up to 8 regions can be defined for a mask. They can be numbered 1-8. They can appear in any order in the .msk file. The numbering of the regions must go from top to bottom, left to right.

An Automask file contains two special regions: the region "glued" to the top of the display, and the region that is "glued" to the bottom. The top region is indicated by y-values of "MAX" for the first and last points. The bottom region is indicated by y-values of "MIN" for the first and last points.

The top region must be the lowest numbered region in the file. The bottom region must be the highest numbered region in the file.

Region number 1 is the top mask region. The vertices in Region 1 describe points along a line; that line is the bottom edge of the top portion of the mask.

Similarly, the vertices in Region 2 describe the line that forms the top of the bottom part of the mask.

The vertices in a mask file are normalized. There are four parameters that define how values are normalized:

- X1
- ΔX
- Y1
- Y2

These four parameters are defined in the Oscilloscope Setup portion of the mask file.

The Y-values (normally voltage) are normalized in the file using the following equation:

$$Y_{\text{norm}} = (Y - Y1)/\Delta Y$$

where $\Delta Y = Y2 - Y1$

To convert the normalized Y-values in the mask file to voltage:

$$Y = (Y_{\text{norm}} * \Delta Y) + Y1$$

where $\Delta Y = Y2 - Y1$

The X-values (normally time) are normalized in the file using the following equation:

$$X_{\text{norm}} = (X - X1)/\Delta X$$

To convert the normalized X-values to time:

$$X = (X_{\text{norm}} * \Delta X) + X1$$

Oscilloscope Setup Information

The keywords "setup" and "end_setup" (appearing alone on a line) define the beginning and end of the oscilloscope setup region of the mask file. The oscilloscope setup information contains remote programming language commands that the oscilloscope executes when the mask file is loaded.

Any legal remote programming command can be entered in this section.

15 Mask Testing

The mask scaling controls how the normalized vectors are interpreted. This in turn controls how the mask is drawn on the display. The remote programming commands that control mask scaling are:

```
:MTES:SCAL:BIND 0
:MTES:SCAL:X1 -400.000E-06
:MTES:SCAL:XDEL +800.000E-06
:MTES:SCAL:Y1 +359.000E-03
:MTES:SCAL:Y2 +2.35900E+00
```

Building a Mask File

The following mask uses all eight mask regions. The most difficult part of creating a mask file is normalizing the X and Y values from the time and voltage values. This example shows an easy way to convert voltage and time to normalized X and Y values in the mask file.

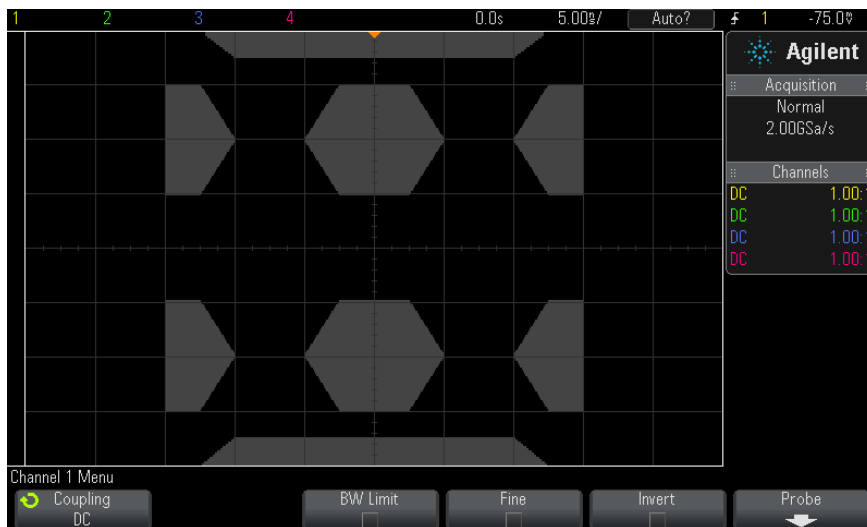

The following mask file produced the mask shown above:

```
MASK_FILE_548XX
"All Regions"
/* Region Number */ 1
/* Number of vertices */ 4
-12.50, MAX
-10.00, 1.750
```

```

        10.00,  1.750
        12.50,   MAX

/* Region Number */ 2
/* Number of vertices */ 5
    -10.00,  1.000
    -12.50,  0.500
    -15.00,  0.500
    -15.00,  1.500
    -12.50,  1.500

/* Region Number */ 3
/* Number of vertices */ 6
    -05.00,  1.000
    -02.50,  0.500
     02.50,  0.500
     05.00,  1.000
     02.50,  1.500
    -02.50,  1.500

/* Region Number */ 4
/* Number of vertices */ 5
     10.00,  1.000
     12.50,  0.500
     15.00,  0.500
     15.00,  1.500
     12.50,  1.500

/* Region Number */ 5
/* Number of vertices */ 5
    -10.00, -1.000
    -12.50, -0.500
    -15.00, -0.500
    -15.00, -1.500
    -12.50, -1.500

/* Region Number */ 6
/* Number of vertices */ 6
    -05.00, -1.000
    -02.50, -0.500
     02.50, -0.500
     05.00, -1.000
     02.50, -1.500
    -02.50, -1.500

/* Region Number */ 7
/* Number of vertices */ 5
     10.00, -1.000
     12.50, -0.500
     15.00, -0.500
     15.00, -1.500
     12.50, -1.500

/* Region Number */ 8
/* Number of vertices */ 4
    -12.50,   MIN
    -10.00, -1.750
     10.00, -1.750
     12.50,   MIN

setup
:MTES:ENAB 1

```

```

:CHAN1:RANG +4.00E+00;OFFS +0.0E+00;COUP DC;IMP ONEM;DISP 1;BWL 0;INV 0
:CHAN1:LAB "1";UNIT VOLT;PROB +1.0E+00;PROB:SKEW +0.0E+00;STYP SING
:CHAN2:RANG +16.0E+00;OFFS +1.62400E+00;COUP DC;IMP FIFT;DISP 0;BWL 0;INV
0
:CHAN2:LAB "2";UNIT VOLT;PROB +1.0E+00;PROB:SKEW +0.0E+00;STYP SING
:CHAN3:RANG +40.0E+00;OFFS +0.0E+00;COUP DC;IMP ONEM;DISP 0;BWL 0;INV 0
:CHAN3:LAB "3";UNIT VOLT;PROB +1.0E+00;PROB:SKEW +0.0E+00;STYP SING
:CHAN4:RANG +40.0E+00;OFFS +0.0E+00;COUP DC;IMP ONEM;DISP 0;BWL 0;INV 0
:CHAN4:LAB "4";UNIT VOLT;PROB +1.0E+00;PROB:SKEW +0.0E+00;STYP SING
:EXT:BWL 0;IMP ONEM;RANG +5E+00;UNIT VOLT;PROB +1.0E+00;PROB:STYP SING
:TIM:MODE MAIN;REF CENT;MAIN:RANG +50.00E-09;POS +0.0E+00
:TRIG:MODE EDGE;SWE AUTO;NREJ 0;HFR 0;HOLD +60E-09
:TRIG:EDGE:SOUR CHAN1;LEV -75.00E-03;SLOP POS;REJ OFF;COUP DC
:ACQ:MODE RTIM;TYPE NORM;COMP 100;COUNT 8;SEGM:COUN 2
:DISP:LAB 0;CONN 1;PERS MIN;SOUR PMEM1
:HARD:APR " ";AREA SCR;FACT 0;FFE 0;INKS 1;PAL NONE;LAY PORT
:SAVE:FIL "mask_0"
:SAVE:IMAG:AREA GRAT;FACT 0;FORM NONE;INKS 0;PAL COL
:SAVE:WAV:FORM NONE
:MTES:SOUR CHAN1;ENAB 1;LOCK 1
:MTES:AMAS:SOUR CHAN1;UNIT DIV;XDEL +3.00000000E-001;YDEL +2.00000000E-00
1
:MTES:SCAL:BIND 0;X1 +0.0E+00;XDEL +1.0000E-09;Y1 +0.0E+00;Y2 +1.00000E+0
0
:MTES:RMOD FOR;RMOD:TIME +1E+00;WAV 1000;SIGM +6.0E+00
:MTES:RMOD:FACT:STOP 0;PRIN 0;SAVE 0
end_setup

```

How is mask testing done?

InfiniiVision oscilloscopes start mask testing by creating a database that is 200 x 640 for the waveform viewing area. Each location in the array is designated as either a violation or a pass area. Each time a data point from a waveform occurs in a violation area a failure is logged. If **Test All** was selected, every active analog channel is tested against the mask database for each acquisition. Over 2 billion failures can be logged per-channel. The number of acquisitions tested is also logged and displayed as "# of Tests".

The mask file allows greater resolution than the 200 X 640 database. Some quantization of data occurs to reduce the mask file data for display on-screen.

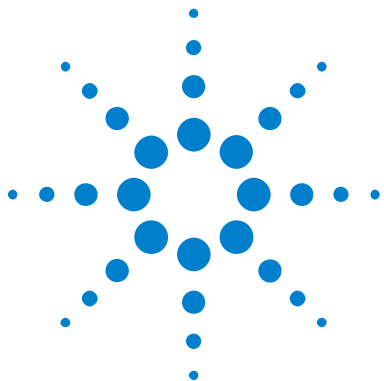

16 Digital Voltmeter

The Digital Voltmeter (DVM) analysis feature provides 3-digit voltage and 5-digit frequency measurements using any analog channel. DVM measurements are asynchronous from the oscilloscope's acquisition system and are always acquiring.

To enable the digital voltmeter analysis feature, order Option DVM at time of oscilloscope purchase, or order DSOXDVM as a stand-alone item after oscilloscope purchase.

The DVM display is a seven-segment readout like you would see on a digital voltmeter. It shows the selected mode as well as the units. Units are selected using the **Units** softkey in the channel's Probe Menu.

After pressing the **[Analyze]** key, the DVM display also appears in the graticule along with a scale and the frequency counter value. The DVM scale is determined by the channel's vertical scale and reference level. The scale's blue triangle pointer shows the most recent measurement. The white bar above that shows the measurement extrema over the last 3 seconds.





The DVM makes accurate RMS measurements when the signal frequency is between 20 Hz and 100 kHz. When the signal frequency is outside this range, "<BW Limit?" or ">BW Limit?" appears in the DVM display to caution you about inaccurate RMS measurement results.

To use the digital voltmeter:

- 1 Press the **[Analyze]** key.
- 2 Press **Features**; then, select **Digital Voltmeter**.
- 3 Press **Features** again to enable the DVM measurements.
- 4 Press the **Source** softkey and turn the Entry knob to select the analog channel on which digital voltmeter (DVM) measurements are made.

The selected channel does not have to be on (displaying a waveform) in order for DVM measurements to be made.

- 5 Press the **Mode** softkey and turn the Entry knob to select the digital voltmeter (DVM) mode:
 - **AC RMS** – displays the root-mean-square value of the acquired data, with the DC component removed.
 - **DC** – displays the DC value of the acquired data.
 - **DC RMS** – displays the root-mean-square value of the acquired data.
 - **Frequency** – displays the frequency counter measurement.

- 6 Press **Transparent** to toggle between a transparent and shaded background for the DVM display.
- 7 If the selected source channel is not used in oscilloscope triggering, press **Auto Range** to disable or enable automatic adjustment of the DVM channel's vertical scale, vertical (ground level) position, and trigger (threshold voltage) level (used for the counter frequency measurement).

When enabled, **Auto Range** overrides attempted adjustments of the channel's vertical scale and position knobs.

When disabled, you can use the channel's vertical scale and position knobs normally.



17 Waveform Generator

- To select generated waveform types and settings [257](#)
- To edit arbitrary waveforms [261](#)
- To output the waveform generator sync pulse [265](#)
- To specify the expected output load [265](#)
- To use waveform generator logic presets [266](#)
- To add noise to the waveform generator output [267](#)
- To add modulation to the waveform generator output [267](#)
- To restore waveform generator defaults [272](#)

A waveform generator is built into the oscilloscope. It is enabled by Option WGN or the DSOX3WAVEGEN upgrade. The waveform generator gives you an easy way to provide input signals when testing circuitry with the oscilloscope.

Waveform generator settings can be saved and recalled with oscilloscope setups. See [Chapter 18](#), “Save/Recall (Setups, Screens, Data),” starting on page 273.

To select generated waveform types and settings

- 1 To access the Waveform Generator Menu and enable or disable the waveform generator output on the front panel Gen Out BNC, press the **[Wave Gen]** key.

When waveform generator output is enabled, the **[Wave Gen]** key is illuminated. When waveform generator output is disabled, the **[Wave Gen]** key is off.



17 Waveform Generator

The waveform generator output is always disabled when the instrument is first turned on.

The waveform generator output is automatically disabled if excessive voltage is applied to the Gen Out BNC.

- 2 In the Waveform Generator Menu, press the **Waveform** softkey and turn the Entry knob to select the waveform type.

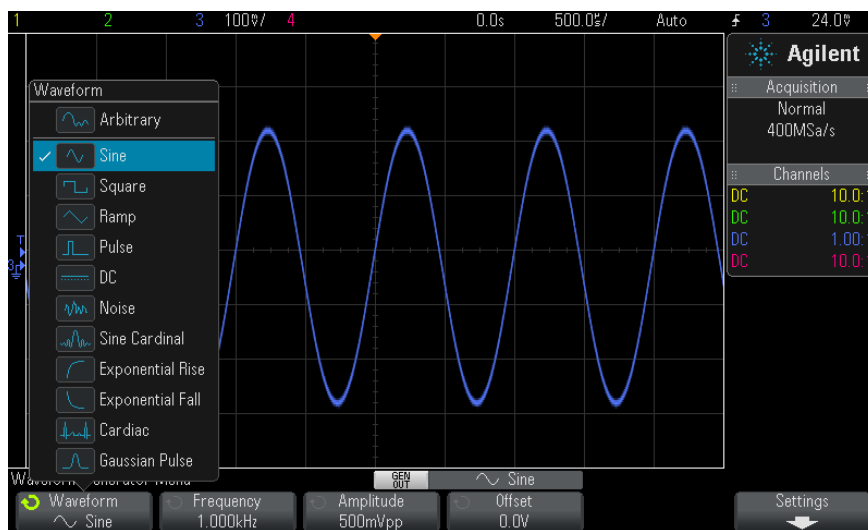

- 3 Depending on the selected waveform type, use the remaining softkeys and the Entry knob to set the waveform's characteristics.

Waveform Type	Characteristics	Frequency Range	Max. Amplitude (High-Z) ¹	Offset (High-Z) ¹
Arbitrary	Use the Frequency/Frequency Fine/Period/Period Fine, Amplitude/High-Level, and Offset/Low-Level softkeys to set the arbitrary waveform signal parameters. Use the Edit Waveform softkey to define the arbitrary waveform shape. See " To edit arbitrary waveforms " on page 261.	100 mHz to 12 MHz	20 mVpp to 5 Vpp	±2.50 V

Waveform Type	Characteristics	Frequency Range	Max. Amplitude (High-Z) ¹	Offset (High-Z) ¹
Sine	Use the Frequency/Frequency Fine/Period/Period Fine, Amplitude/High-Level, and Offset/Low-Level softkeys to set the sine signal parameters.	100 mHz to 20 MHz	20 mVpp to 5 Vpp	±2.50 V
Square	Use the Frequency/Frequency Fine/Period/Period Fine, Amplitude/High-Level, Offset/Low-Level, and Duty Cycle softkeys to set the square wave signal parameters. The duty cycle can be adjusted from 20% to 80%.	100 mHz to 10 MHz	20 mVpp to 5 Vpp	±2.50 V
Ramp	Use the Frequency/Frequency Fine/Period/Period Fine, Amplitude/High-Level, Offset/Low-Level, and Symmetry softkeys to set the ramp signal parameters. Symmetry represents the amount of time per cycle that the ramp waveform is rising and can be adjusted from 0% to 100%.	100 mHz to 200 kHz	20 mVpp to 5 Vpp	±2.50 V
Pulse	Use the Frequency/Frequency Fine/Period/Period Fine, Amplitude/High-Level, Offset/Low-Level, and Width/Width Fine softkeys to set the pulse signal parameters. The pulse width can be adjusted from 20 ns to the period minus 20 ns.	100 mHz to 10 MHz.	20 mVpp to 5 Vpp	±2.50 V
DC	Use the Offset softkey to set the DC level.	n/a	n/a	±2.50 V
Noise	Use the Amplitude/High-Level and Offset/Low-Level to set the noise signal parameters.	n/a	20 mVpp to 5 Vpp	±2.50 V
Sine Cardinal	Use the Frequency/Frequency Fine/Period/Period Fine, Amplitude, and Offset softkeys to set the sinc signal parameters.	100 mHz to 1 MHz	20 mVpp to 5 Vpp	±1.25 V
Exponential Rise	Use the Frequency/Frequency Fine/Period/Period Fine, Amplitude/High-Level, and Offset/Low-Level softkeys to set the exponential rise signal parameters.	100 mHz to 5 MHz	20 mVpp to 5 Vpp	±2.50 V

17 Waveform Generator

Waveform Type	Characteristics	Frequency Range	Max. Amplitude (High-Z) ¹	Offset (High-Z) ¹
Exponential Fall	Use the Frequency/Frequency Fine/Period/Period Fine, Amplitude/High-Level, and Offset/Low-Level softkeys to set the exponential fall signal parameters.	100 mHz to 5 MHz	20 mVpp to 5 Vpp	±2.50 V
Cardiac	Use the Frequency/Frequency Fine/Period/Period Fine, Amplitude, and Offset softkeys to set the cardiac signal parameters.	100 mHz to 200 kHz	20 mVpp to 5 Vpp	±1.25 V
Gaussian Pulse	Use the Frequency/Frequency Fine/Period/Period Fine, Amplitude, and Offset softkeys to set the gaussian pulse signal parameters.	100 mHz to 5 MHz	20 mVpp to 4 Vpp	±1.25 V

¹When the output load is 50 Ω, these values are halved.

Pressing a signal parameter softkey can open a menu for selecting the type of adjustment. For example, you can choose to enter amplitude and offset values, or you can choose to enter high-level and low-level values. Or, you can choose to enter frequency values or period values. Keep pressing the softkey to select the type of adjustment. Turn the Entry knob to adjust the value.

Notice that you can select between coarse and fine adjustments for frequency, period, and width. Also, pushing the Entry knob is a quick way to toggle between coarse and fine adjustments.

The **Settings** softkey opens the Waveform Generator Settings Menu which lets you make other settings related to the waveform generator.



See:

- ["To output the waveform generator sync pulse"](#) on page 265
- ["To specify the expected output load"](#) on page 265
- ["To use waveform generator logic presets"](#) on page 266

- "To add noise to the waveform generator output" on page 267
- "To restore waveform generator defaults" on page 272

To edit arbitrary waveforms

- 1 When **Arbitrary** is selected as the generated waveform type (see "To select generated waveform types and settings" on page 257), press the **Edit Waveform** softkey to open the Edit Waveform Menu.



When you open the Edit Waveform Menu, you see the existing arbitrary waveform definition. The voltage and time period you see in the diagram are the bounding parameters – they come from the frequency and amplitude settings in the main Waveform Generator Menu.

- 2 Use the softkeys in the Edit Waveform Menu to define the shape of the arbitrary waveform:

Softkey	Description
Create New	Opens the New Waveform Menu. See "Creating New Arbitrary Waveforms" on page 262.

Softkey	Description
Edit Existing	Opens the Edit Waveform Points Menu. See "Editing Existing Arbitrary Waveforms" on page 263.
Interpolate	Specifies how lines are drawn between arbitrary waveform points. When enabled, lines are drawn between points in the waveform editor. Voltage levels change linearly between one point and the next. When disabled, all line segments in the waveform editor are horizontal. The voltage level of one point remains until the next point.
Source	Selects the analog channel or reference waveform to be captured and stored to the arbitrary waveform. See "Capturing Other Waveforms to the Arbitrary Waveform" on page 264.
Store Source to Arb	Captures the selected waveform source and copy it to the arbitrary waveform. See "Capturing Other Waveforms to the Arbitrary Waveform" on page 264.

NOTE

You can use the [**Save/Recall**] key and menu to save arbitrary waveforms to one of four internal storage locations or to a USB storage device, and you can recall them later. See ["To save arbitrary waveforms"](#) on page 282 and ["To recall arbitrary waveforms"](#) on page 285.

Creating New Arbitrary Waveforms

The New Waveform Menu is opened by pressing **Create New** in the Edit Waveform Menu.



To create a new arbitrary waveform:

- 1 In the New Waveform Menu, press **Initial Pts**; then, use the Entry knob to select the initial number of points in the new waveform.

The new waveform will be a square wave with the number of points you specify. The points are evenly spaced over the time period.

- 2 Use the **Frequency/Frequency Fine/Period/Period Fine** softkey to set the time period bounding parameter (repetition frequency) of the arbitrary waveform.
- 3 Use the **Amplitude/High-Level** and **Offset/Low-Level** softkeys to set the voltage bounding parameter of the arbitrary waveform.

- When you are ready to create the new arbitrary waveform, press **Apply & Edit**.

CAUTION

When you create a new arbitrary waveform, the existing arbitrary waveform definition is overwritten. Note that you can use the **[Save/Recall]** key and menu to save arbitrary waveforms to one of four internal storage locations or to a USB storage device, and you can recall them later. See ["To save arbitrary waveforms"](#) on page 282 and ["To recall arbitrary waveforms"](#) on page 285.

The new waveform is created and the Edit Waveform Points menu is opened. See ["Editing Existing Arbitrary Waveforms"](#) on page 263.

Note that you can also create a new arbitrary waveform by capturing another waveform. See ["Capturing Other Waveforms to the Arbitrary Waveform"](#) on page 264.

Editing Existing Arbitrary Waveforms

The Edit Waveform Points Menu is opened by pressing **Edit Existing** in the Edit Waveform Menu or by pressing **Apply & Edit** when creating a new arbitrary waveform.



17 Waveform Generator

To specify the voltage values of points:

- 1 Press **Point #**; then, use the Entry knob to select the point whose voltage value you wish to set.
- 2 Press **Voltage**; then, use the Entry knob to set the point's voltage value.

To insert a point:

- 1 Press **Point #**; then, use the Entry knob to select the point after which the new point will be inserted.
- 2 Press **Insert Point**.

All points are adjusted to maintain uniform time spacing between points.

To remove a point:

- 1 Press **Point #**; then, use the Entry knob to select the point you want to remove.
- 2 Press **Remove Point**.

All points are adjusted to maintain uniform time spacing between points.

The **Transparent** softkey enables or disables transparent backgrounds. When enabled, you can view underlying waveforms. When disabled, the background is shaded.

Capturing Other Waveforms to the Arbitrary Waveform

The Edit Waveform Menu is opened by pressing **Edit Waveform** in the main Waveform Generator Menu.



To capture another waveform to the arbitrary waveform:

- 1 Press **Source**; then, use the Entry knob to select the analog channel, math, or reference location whose waveform you wish to capture.
- 2 Press **Store Source to Arb**.

CAUTION

When you create a new arbitrary waveform, the existing arbitrary waveform definition is overwritten. Note that you can use the **[Save/Recall]** key and menu to save arbitrary waveforms to one of four internal storage locations or to a USB storage device, and you can recall them later. See ["To save arbitrary waveforms"](#) on page 282 and ["To recall arbitrary waveforms"](#) on page 285.

The source waveform is decimated into 8192 (maximum) or fewer arbitrary waveform points.

NOTE

If the source waveform frequency and/or voltage exceed the capabilities of the waveform generator, the arbitrary waveform will be limited to the capabilities of the waveform generator. For example, a 20 MHz waveform captured as the arbitrary waveform, becomes a 12 MHz waveform.

To output the waveform generator sync pulse

- 1 If the Waveform Generator Menu is not currently displayed on the oscilloscope's softkeys, press the **[Wave Gen]** key.
- 2 In the Waveform Generator Menu, press the **Settings** softkey.
- 3 In the Waveform Generator Settings Menu, press the **Trig Out** softkey and turn the Entry knob to select **Waveform Generator Sync Pulse**.

Waveform Type	Sync Signal Characteristics
All waveforms except DC, Noise, and Cardiac	The Sync signal is a TTL positive pulse that occurs when the waveform rises above zero volts (or the DC offset value).
DC, Noise, and Cardiac	N/A

To specify the expected output load

- 1 If the Waveform Generator Menu is not currently displayed on the oscilloscope's softkeys, press the **[Wave Gen]** key.

- 2 In the Waveform Generator Menu, press the **Settings** softkey.
- 3 In the Waveform Generator Settings Menu, press the **Out Load** softkey and turn the Entry knob to select:
 - **50 Ω**
 - **High-Z**

The output impedance of the Gen Out BNC is fixed at 50 ohms. However, the output load selection lets the waveform generator display the correct amplitude and offset levels for the expected output load.

If the actual load impedance is different than the selected value, the displayed amplitude and offset levels will be incorrect.

To use waveform generator logic presets

With logic level presets, you can easily set the output voltage to TTL, CMOS (5.0V), CMOS (3.3V), CMOS (2.5V), or ECL compatible Low and High levels.

- 1 If the Waveform Generator Menu is not currently displayed on the oscilloscope's softkeys, press the **[Wave Gen]** key.
- 2 In the Waveform Generator Menu, press the **Settings** softkey.
- 3 In the Waveform Generator Settings Menu, press the **Logic Presets** softkey.
- 4 In the Waveform Generator Logic Level Presets Menu, press one of the softkeys to set the generated signal's Low and High voltages to logic compatible levels:

Softkey (logic levels)	Low level	High level, 50 ohm expected output load	High level, high-Z expected output load
TTL	0 V	+2.5 V (TTL compatible)	+5 V
CMOS (5.0V)	0 V	Not Available	+5 V
CMOS (3.3V)	0 V	+2.5 V (CMOS compatible)	+3.3 V
CMOS (2.5V)	0 V	+2.5 V	+2.5 V
ECL	-1.7 V	-0.8 V (ECL compatible)	-0.9 V

To add noise to the waveform generator output

- 1 If the Waveform Generator Menu is not currently displayed on the oscilloscope's softkeys, press the **[Wave Gen]** key.
- 2 In the Waveform Generator Menu, press the **Settings** softkey.
- 3 In the Waveform Generator Settings Menu, press the **Add Noise** softkey and turn the Entry knob to select the amount of white noise to add to the waveform generator output.

Note that adding noise affects edge triggering on the waveform generator source (see ["Edge Trigger"](#) on page 146) as well as the waveform generator sync pulse output signal (which can be sent to TRIG OUT, see ["Setting the Rear Panel TRIG OUT Source"](#) on page 304). This is because the trigger comparator is located after the noise source.

To add modulation to the waveform generator output

Modulation is where an original carrier signal is modified according to the amplitude of a second modulating signal. The modulation type (AM, FM, or FSK) specifies how the carrier signal is modified.

To enable and set up modulation for the waveform generator output:

- 1 If the Waveform Generator Menu is not currently displayed on the oscilloscope's softkeys, press the **[Wave Gen]** key.
- 2 In the Waveform Generator Menu, press the **Settings** softkey.
- 3 In the Waveform Generator Settings Menu, press the **Modulation** softkey.
- 4 In the Waveform Generator Modulation Menu:



- Press the **Modulation** softkey to enable or disable modulated waveform generator output.

You can enable modulation for all waveform generator function types except pulse, DC, and noise.

- Press the **Type** softkey and turn the Entry knob to select the modulation type:
 - **Amplitude Modulation (AM)** – the amplitude of the original carrier signal is modified according to the amplitude of the modulating signal. See "[To set up Amplitude Modulation \(AM\)](#)" on page 268.
 - **Frequency Modulation (FM)** – the frequency of the original carrier signal is modified according to the amplitude of the modulating signal. See "[To set up Frequency Modulation \(FM\)](#)" on page 269.
 - **Frequency-Shift Keying Modulation (FSK)** – the output frequency "shifts" between the original carrier frequency and a "hop frequency" at the specified FSK rate. The FSK rate specifies a digital square wave modulating signal. See "[To set up Frequency-Shift Keying Modulation \(FSK\)](#)" on page 271.

To set up Amplitude Modulation (AM)

In the Waveform Generator Modulation Menu (under **[Wave Gen] > Settings > Modulation**):

- 1 Press the **Type** softkey and turn the Entry knob to select **Amplitude Modulation (AM)**.
- 2 Press the **Waveform** softkey and turn the Entry knob to select the shape of the modulating signal:
 - **Sine**
 - **Square**
 - **Ramp**
 - **Sine Cardinal**
 - **Exponential Rise**
 - **Exponential Fall**

When the **Ramp** shape is selected, a **Symmetry** softkey appears so that you can specify the amount of time per cycle that the ramp waveform is rising.

- 3 Press the **AM Freq** softkey and turn the Entry knob to specify the frequency of the modulating signal.
- 4 Press the **AM Depth** softkey and turn the Entry knob to specify the amount of amplitude modulation.

AM Depth refers to the portion of the amplitude range that will be used by the modulation. For example, a depth setting of 80% causes the output amplitude to vary from 10% to 90% (90% – 10% = 80%) of the original amplitude as the modulating signal goes from its minimum to maximum amplitude.

The following screen shows an AM modulation of a 100 kHz sine wave carrier signal.

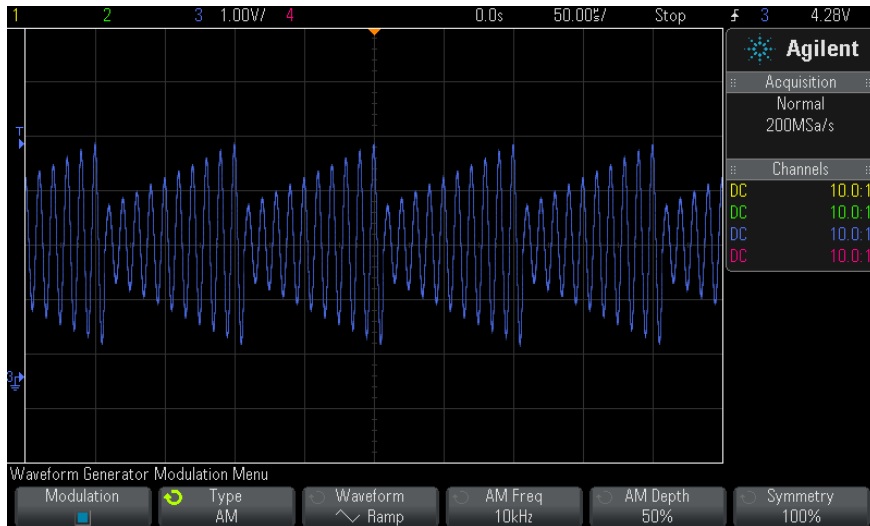

To set up Frequency Modulation (FM)

In the Waveform Generator Modulation Menu (under **[Wave Gen] > Settings > Modulation**):

- 1 Press the **Type** softkey and turn the Entry knob to select **Frequency Modulation (FM)**.
- 2 Press the **Waveform** softkey and turn the Entry knob to select the shape of the modulating signal:
 - **Sine**
 - **Square**
 - **Ramp**

- **Sine Cardinal**
- **Exponential Rise**
- **Exponential Fall**

When the **Ramp** shape is selected, a **Symmetry** softkey appears so that you can specify the amount of time per cycle that the ramp waveform is rising.

- 3** Press the **FM Freq** softkey and turn the Entry knob to specify the frequency of the modulating signal.
- 4** Press the **FM Dev** softkey and turn the Entry knob to specify the frequency deviation from the original carrier signal frequency.

When the modulating signal is at its maximum amplitude, the output frequency is the carrier signal frequency plus the deviation amount, and when the modulating signal is at its minimum amplitude, the output frequency is the carrier signal frequency minus the deviation amount.

The frequency deviation cannot be greater than the original carrier signal frequency.

Also, the sum of the original carrier signal frequency and the frequency deviation must be less than or equal to the maximum frequency for the selected waveform generator function plus 100 kHz.

The following screen shows an FM modulation of a 100 kHz sine wave carrier signal.

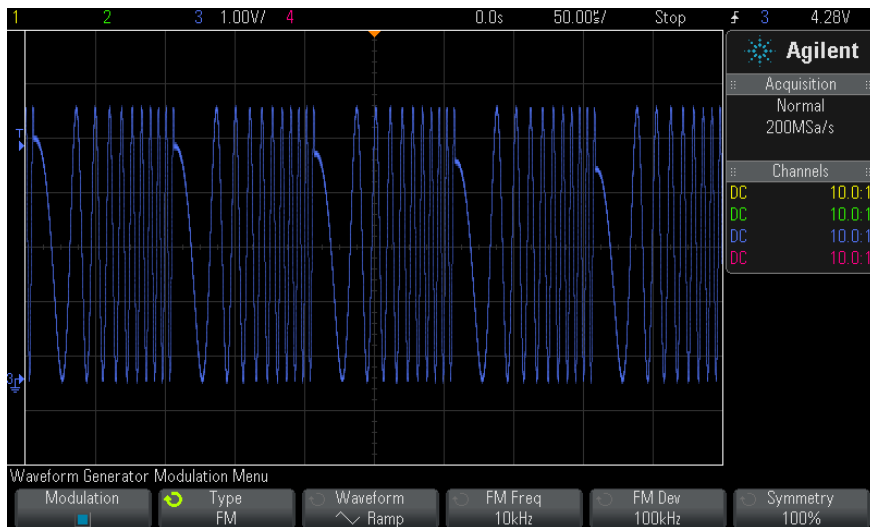

To set up Frequency-Shift Keying Modulation (FSK)

In the Waveform Generator Modulation Menu (under **[Wave Gen] > Settings > Modulation**):

- 1 Press the **Type** softkey and turn the Entry knob to select **Frequency-Shift Keying Modulation (FSK)**.
- 2 Press the **Hop Freq** softkey and turn the Entry knob to specify the "hop frequency".

The output frequency "shifts" between the original carrier frequency and this "hop frequency".

- 3 Press the **FSK Rate** softkey and turn the Entry knob to specify the rate at which the output frequency "shifts".

The FSK rate specifies a digital square wave modulating signal.

The following screen shows an FSK modulation of a 100 kHz sine wave carrier signal.

17 Waveform Generator

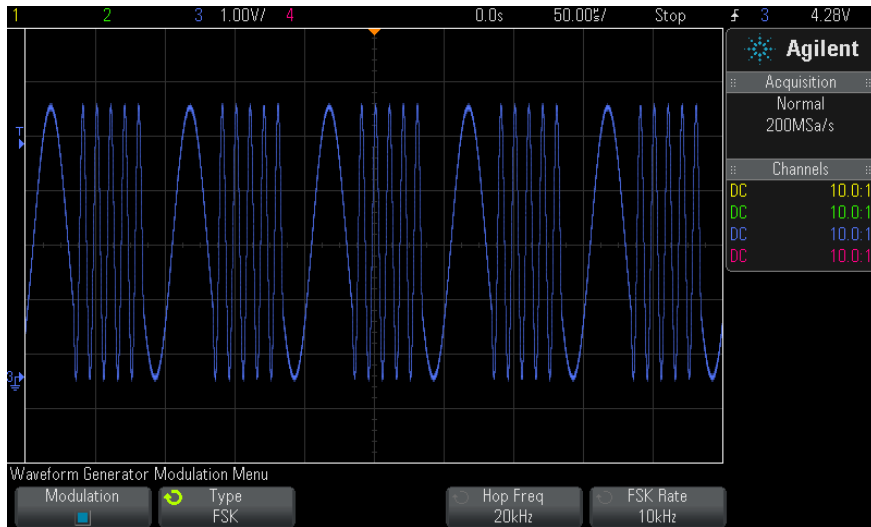

To restore waveform generator defaults

- 1 If the Waveform Generator Menu is not currently displayed on the oscilloscope's softkeys, press the **[Wave Gen]** key.
- 2 In the Waveform Generator Menu, press the **Settings** softkey.
- 3 In the Waveform Generator Settings Menu, press the **Default Wave Gen** softkey.

The waveform generator factory default settings (1 kHz sine wave, 500 mVpp, 0 V offset, High-Z output load) are restored.



18 Save/Recall (Setups, Screens, Data)

Saving Setups, Screen Images, or Data [273](#)

Recalling Setups, Masks, or Data [284](#)

Recalling Default Setups [286](#)

Performing a Secure Erase [287](#)

Oscilloscope setups, reference waveforms, and mask files can be saved to internal oscilloscope memory or to a USB storage device and recalled later. You can also recall default or factory default setups.

Oscilloscope screen images can be saved to a USB storage device in BMP or PNG formats.

Acquired waveform data can be saved to a USB storage device in comma-separated value (CSV), ASCII XY, binary (BIN), and Agilent logic analyzer binary (ALB) formats.

There is also a command to securely erase all the oscilloscope's non-volatile internal memory.

Saving Setups, Screen Images, or Data

- 1 Press the [**Save/Recall**] key.
- 2 In the Save/Recall Menu, press **Save**.
- 3 In the Save Trace and Setup Menu, press **Format**; then, turn the Entry knob to select the type of file you want to save:



- **Setup (*.scp)** – The oscilloscope's horizontal timebase, vertical sensitivity, trigger mode, trigger level, measurements, cursors, and math function settings that tell the oscilloscope how to make a particular measurement. See ["To save setup files"](#) on page 275.
- **8-bit Bitmap image (*.bmp)** – The complete screen image in a reduced color (8-bit) bitmap format. See ["To save BMP or PNG image files"](#) on page 275.
- **24-bit Bitmap image (*.bmp)** – The complete screen image in a 24-bit color bitmap format. See ["To save BMP or PNG image files"](#) on page 275.
- **24-bit image (*.png)** – The complete screen image in a 24-bit color PNG format that uses lossless compression. Files are much smaller than the BMP format. See ["To save BMP or PNG image files"](#) on page 275.
- **CSV data (*.csv)** – This creates a file of comma-separated values of all displayed channels and math waveforms. This format is suitable for spreadsheet analysis. See ["To save CSV, ASCII XY, or BIN data files"](#) on page 277.
- **ASCII XY data (*.csv)** – This creates separate files of comma-separated values for each displayed channel. This format is also suitable for spreadsheets. See ["To save CSV, ASCII XY, or BIN data files"](#) on page 277.
- **Reference Waveform data (*.h5)** – Saves waveform data in a format that can be recalled to one of the oscilloscope's reference waveform locations. See ["To save reference waveform files to a USB storage device"](#) on page 281.
- **ALB data (*.alb)** – This creates an Agilent proprietary format file that can be imported by the *Agilent Logic Analyzer* application software, using the Agilent B4610A Data Import tool, for offline viewing and analysis. See ["To save ALB data files"](#) on page 277.
- **Binary data (*.bin)** – This creates a binary file, with a header, and data in the form of time and voltage pairs. This file is much smaller than the ASCII XY data file. See ["To save CSV, ASCII XY, or BIN data files"](#) on page 277.
- **Lister data (*.csv)** – This is a CSV format file containing serial decode row information with commas separating the columns. See ["To save Lister data files"](#) on page 281.

- **Mask (*.msk)** – This creates a mask file in an Agilent proprietary format that can be read by Agilent InfiniiVision oscilloscopes. A mask data file includes some oscilloscope setup information, but not all setup information. To save all setup information including the mask data file, choose "Setup (*.scp)" format instead. See ["To save masks"](#) on page 281.
- **Arbitrary Waveform data (*.csv)** – This creates a file of comma-separated values for the arbitrary waveform points' time and voltage values. See ["To save arbitrary waveforms"](#) on page 282.
- **Power Harmonics data (*.csv)** – When the DSOX3PWR power analysis application is licensed, this creates a file of comma-separated values for the current harmonics power analysis results. See the *DSOX3PWR Power Measurement Application User's Guide* for more information.

You can also configure the **[Quick Action]** key to save setups, screen images, or data. See ["Configuring the \[Quick Action\] Key"](#) on page 311.

To save setup files

Setup files can be saved to one of 10 internal (\Agilent Flash) locations or to an external USB storage device.

- 1 Press **[Save/Recall] > Save > Format**; then, turn the Entry knob to select **Setup (*.scp)**.
- 2 Press the softkey in the second position and use the Entry knob to navigate to the save location. See ["To navigate storage locations"](#) on page 282.
- 3 Finally, press the **Press to Save** softkey.

A message indicating whether the save was successful is displayed.

Setup files have the extension SCP. These extensions appear when using the File Explorer (see ["File Explorer"](#) on page 299), but they do not appear when using the Recall Menu.

To save BMP or PNG image files

Image files can be saved to an external USB storage device.

- 1 Press **[Save/Recall] > Save > Format**; then, turn the Entry knob to select **8-bit Bitmap image (*.bmp)**, **24-bit Bitmap image (*.bmp)**, or **24-bit image (*.png)**.

18 Save/Recall (Setups, Screens, Data)

- 2 Press the softkey in the second position and use the Entry knob to navigate to the save location. See ["To navigate storage locations"](#) on page 282.
- 3 Press the **Settings** softkey.

In the File Settings Menu, you have these softkeys and options:

- **Setup Info** – setup information (vertical, horizontal, trigger, acquisition, math, and display settings) is also saved in a separate file with a TXT extension.
- **Invert Graticule** – the graticule in the image file has a white background instead of the black background that appears on-screen.



Graticule Not Inverted

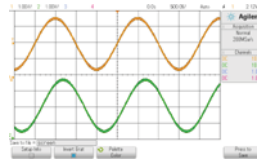

Graticule Inverted

- **Palette** – lets you choose between **Color** or **Grayscale** images.
- 4 Finally, press the **Press to Save** softkey.

A message indicating whether the save was successful is displayed.

NOTE

When saving screen images, the oscilloscope uses the last menu visited before pressing the **[Save/Recall]** key. This lets you save any relevant information within the softkey menu area.

To save a screen image showing the Save/Recall Menu at the bottom, press the **[Save/Recall]** key twice before saving the image.

NOTE

You can also save the oscilloscope's display image using a web browser. See ["Get Image"](#) on page 325 for details.

See Also • ["Adding an Annotation"](#) on page 312

To save CSV, ASCII XY, or BIN data files

Data files can be saved to an external USB storage device.

- 1 Press [**Save/Recall**] > **Save** > **Format**; then, turn the Entry knob to select **CSV data (*.csv)**, **ASCII XY data (*.csv)**, or **Binary data (*.bin)**.
- 2 Press the softkey in the second position and use the Entry knob to navigate to the save location. See "[To navigate storage locations](#)" on page 282.
- 3 Press the **Settings** softkey.

In the File Settings Menu, you have these softkeys and options:

- **Setup Info** – when enabled, setup information (vertical, horizontal, trigger, acquisition, math, and display settings) is also saved in a separate file with a TXT extension.
 - **Length** – sets the number of data points that will be output to the file. For more information, see "[Length Control](#)" on page 279.
 - **Save Seg** – when data is acquired to segmented memory, you can specify whether the currently displayed segment is saved or all acquired segments are saved. (See also "[Saving Data from Segmented Memory](#)" on page 202.)
- 4 Finally, press the **Press to Save** softkey.

A message indicating whether the save was successful is displayed.

- See Also**
- "[Binary Data \(.bin\) Format](#)" on page 342
 - "[CSV and ASCII XY files](#)" on page 348
 - "[Minimum and Maximum Values in CSV Files](#)" on page 349

To save ALB data files

Agilent logic analyzer binary (ALB) format data files can be viewed and analyzed offline on a PC using the *Agilent Logic Analyzer* application and the Agilent B4610A Data Import Tool. See the "[Agilent Technologies B4610A Data Import Tool for Offline Viewing and Analysis Data Sheet](#) (publication number 5989-7834EN)".

ALB data files can be saved to an external USB storage device.

- 1 Press [**Save/Recall**] > **Save** > **Format**; then, turn the Entry knob to select **ALB data (*.alb)**.

18 Save/Recall (Setups, Screens, Data)

- 2 Press the softkey in the second position and use the Entry knob to navigate to the save location. See "[To navigate storage locations](#)" on page 282.
- 3 Press the **Settings** softkey.

In the File Settings Menu, you have these softkeys and options:

- **Setup Info** – when enabled, setup information (vertical, horizontal, trigger, acquisition, math, and display settings) is also saved in a separate file with a TXT extension.
- **Length** – sets the number of data points that will be output to the file. For more information, see "[Length Control](#)" on page 279.
- **Alb Format** – Available ALB serial formats include:
 - Default
 - CAN
 - I2C
 - LIN
 - UART/RS232
 - SPI (2 Wire Serial)
 - SPI (3 Wire Serial)
 - SPI (4 Wire Serial)

When you choose any ALB format other than Default, waveforms from the analog channels (if displayed) are also digitized and displayed as digital waveforms. The analog channel's trigger level determines the point at which the voltage is considered a logic 1 or 0.

If you connect your serial bus signals to the oscilloscope as shown in the following table, the bus/signal names in the *Agilent Logic Analyzer* application will be correct. Otherwise, you must re-map the signals in the *Agilent Logic Analyzer* application.

Table 5 Recommended Signal Mapping

Label	Signal	Oscilloscope Channel	Maps to Logic Analyzer Channel
TxRS232	Tx	Ch1	D0
RxRS232	Rx	Ch2	D1
I2C	Data	Ch1	D0
	Clk	Ch2	D1
SPI2 (2-wire)	Clk	Ch1	D0
	Data	Ch2	D1
SPI3 (3-wire)	~Chip Select	Ch1	D0
	Clk	Ch2	D1
	Data	Ch3	D2
SPI4 (4-wire)	~Chip Select	Ch1	D0
	Clk	Ch2	D1
	DataIn	Ch3	D2
	DataOut	Ch4	D3
CAN	Data	Ch1	D0
LIN	Data	Ch1	D0

4 Finally, press the **Press to Save** softkey.

A message indicating whether the save was successful is displayed.

Length Control

The **Length** control is available when saving data to CSV, ASCII XY, BIN, or ALB format files. It sets the number of data points that will be output to the file. Only displayed data points are saved.

The maximum number of data points depends on these things:

18 Save/Recall (Setups, Screens, Data)

- Whether acquisitions are running. When stopped, data comes from the raw acquisition record. When running, data comes from the smaller measurement record.
- Whether the oscilloscope was stopped using **[Stop]** or **[Single]**. Running acquisitions split memory to provide fast waveform update rates. Single acquisitions use full memory.
- Whether only one channel of a pair is turned on. (Channels 1 and 2 are one pair, channels 3 and 4 are the other.) Acquisition memory is divided among the channels in a pair.
- Whether reference waveforms are on. Displayed reference waveforms consume acquisition memory.
- Whether digital channels are on. Displayed digital channels consume acquisition memory.
- Whether segmented memory is on. Acquisition memory is divided by the number of segments.
- The horizontal time/div (sweep speed) setting. At faster settings, fewer data points appear on the display.
- When saving to a CSV format file, the maximum number of data points is 64K.

When necessary, the Length control performs a "1 of n" decimation of the data. For example: if the **Length** is set to 1000, and you are displaying a record that is 5000 data points in length, four of each five data points will be decimated, creating an output file 1000 data points in length.

When saving waveform data, the save times depend on the chosen format:

Data File Format	Save Times
BIN, ALB	fastest
ASCII XY	medium
CSV	slowest

- See Also**
- ["Binary Data \(.bin\) Format"](#) on page 342
 - ["CSV and ASCII XY files"](#) on page 348
 - ["Minimum and Maximum Values in CSV Files"](#) on page 349

To save Lister data files

Lister data files can be saved to an external USB storage device.

- 1 Press [**Save/Recall**] > **Save** > **Format**; then, turn the Entry knob to select **Lister data file**.
- 2 Press the softkey in the second position and use the Entry knob to navigate to the save location. See "[To navigate storage locations](#)" on page 282.
- 3 Press the **Settings** softkey.

In the File Settings Menu, you have these softkeys and options:

- **Setup Info** – when enabled, setup information (vertical, horizontal, trigger, acquisition, math, and display settings) is also saved in a separate file with a TXT extension.
- 4 Finally, press the **Press to Save** softkey.

A message indicating whether the save was successful is displayed.

To save reference waveform files to a USB storage device

- 1 Press the [**Save/Recall**] key.
- 2 In the Save/Recall Menu, press the **Save** softkey.
- 3 In the Save Menu, press the **Format** softkey and turn the Entry knob to select **Reference Waveform data (*.h5)**.
- 4 Press the **Source** softkey and turn the Entry knob to select the source waveform.
- 5 Press the softkey in the second position and use the Entry knob to navigate to the save location. See "[To navigate storage locations](#)" on page 282.
- 6 Finally, press the **Press to Save** softkey.

A message indicating whether the save was successful is displayed.

To save masks

Mask files can be saved to one of four internal (\Agilent Flash) locations or to an external USB storage device.

- 1 Press [**Save/Recall**] > **Save** > **Format**; then, turn the Entry knob to select **Mask (*.msk)**.

18 Save/Recall (Setups, Screens, Data)

2 Press the softkey in the second position and use the Entry knob to navigate to the save location. See "[To navigate storage locations](#)" on page 282.

3 Finally, press the **Press to Save** softkey.

A message indicating whether the save was successful is displayed.

Mask files have the extension MSK.

NOTE

Masks are also saved as part of setup files. See "[To save setup files](#)" on page 275.

See Also • [Chapter 15](#), "Mask Testing," starting on page 241

To save arbitrary waveforms

Arbitrary waveform files can be saved to one of four internal (\Agilent Flash) locations or to an external USB storage device.

1 Press [**Save/Recall**] > **Save** > **Format**; then, turn the Entry knob to select **Arbitrary Waveform data (*.csv)**.

2 Press the softkey in the second position and use the Entry knob to navigate to the save location. See "[To navigate storage locations](#)" on page 282.

3 Finally, press the **Press to Save** softkey.

A message indicating whether the save was successful is displayed.

See Also • "[To edit arbitrary waveforms](#)" on page 261

To navigate storage locations

When saving or recalling files, the softkey in the second position of the Save Menu or Recall Menu, along with the Entry knob, are used to navigate to storage locations. The storage locations can be internal oscilloscope storage locations (for setup files or mask files) or they can be external storage locations on a connected USB storage device.

The softkey in the second position can have these labels:

- **Press to go** – when you can push the Entry knob to navigate to a new folder or storage location.
- **Location** – when you have navigated to the current folder location (and are not saving files).
- **Save to** – when you can save to the selected location.
- **Load from** – when you can recall from the selected file.

When saving files:

- The proposed file name is shown in the **Save to file =** line above the softkeys.
- To overwrite an existing file, browse to that file and select it. To create a new file name, see ["To enter file names"](#) on page 283.

To enter file names

To create new file names when saving files to a USB storage device:

- 1 In the Save Menu, press the **File Name** softkey.

You must have a USB storage device connected to the oscilloscope for this softkey to be active.

- 2 In the File Name Menu, use the **Spell**, **Enter**, and **Delete Character** softkeys to enter the file name:
 - **Spell** – press this softkey and turn the Entry knob to select the character at the current position.
 - **Enter** – press this softkey to enter characters and move the cursor to the next character position. Pushing the Entry knob is the same as pressing the **Enter** softkey.
 - **Delete Character** – press this softkey to delete the character at the current position.

NOTE

You can use a connected USB keyboard instead of using the **Spell** (and other) character editing softkeys.

When available, the **Increment** softkey can be used to enable or disable automatically incremented file names. Auto increment adds a numeric suffix to your file name and increments the number with each

successive save. It will truncate characters as necessary when the file name length is at maximum and more digits are required for the numeric portion of the file name.

Recalling Setups, Masks, or Data

- 1 Press the [**Save/Recall**] key.
- 2 In the Save/Recall Menu, press **Recall**.
- 3 In the Recall Menu, press **Recall**; then, turn the Entry knob to select the type of file you want to recall:
 - **Setup (*.scp)** – See ["To recall setup files"](#) on page 284.
 - **Mask (*.msk)** – See ["To recall mask files"](#) on page 285.
 - **Reference Waveform data (*.h5)** – See ["To recall reference waveform files from a USB storage device"](#) on page 285.
 - **Arbitrary Waveform data (*.csv)** – See ["To recall arbitrary waveforms"](#) on page 285.

You can also recall setups and mask files by loading them using the File Explorer. See ["File Explorer"](#) on page 299.

You can also configure the [**Quick Action**] key to recall setups, masks, or reference waveforms. See ["Configuring the \[Quick Action\] Key"](#) on page 311.

To recall setup files

Setup files can be recalled from one of 10 internal (\Agilent Flash) locations or from an external USB storage device.

- 1 Press [**Save/Recall**] > **Recall** > **Recall**; then, turn the Entry knob to select **Setup (*.scp)**.
- 2 Press the softkey in the second position and use the Entry knob to navigate to the file to recall. See ["To navigate storage locations"](#) on page 282.
- 3 Press the **Press to Recall** softkey.

A message indicating whether the recall was successful is displayed.

- 4 If you would like to clear the display, press **Clear Display**.

To recall mask files

Mask files can be recalled from one of four internal (\Agilent Flash) locations or from an external USB storage device.

- 1 Press [**Save/Recall**] > **Recall** > **Recall**; then, turn the Entry knob to select **Mask (*.msk)**.
- 2 Press the softkey in the second position and use the Entry knob to navigate to the file to recall. See "[To navigate storage locations](#)" on page 282.
- 3 Press the **Press to Recall** softkey.

A message indicating whether the recall was successful is displayed.

- 4 If you would like to clear the display or clear the recalled mask, press **Clear Display** or **Clear Mask**.

To recall reference waveform files from a USB storage device

- 1 Press the [**Save/Recall**] key.
- 2 In the Save/Recall Menu, press the **Recall** softkey.
- 3 In the Recall Menu, press the **Recall** softkey and turn the Entry knob to select **Reference Waveform data (*.h5)**.
- 4 Press the **To Ref:** softkey and turn the Entry knob to select the desired reference waveform location.
- 5 Press the softkey in the second position and use the Entry knob to navigate to the file to recall. See "[To navigate storage locations](#)" on page 282.
- 6 Press the **Press to Recall** softkey.

A message indicating whether the recall was successful is displayed.

- 7 If you would like to clear the display of everything except the reference waveform, press **Clear Display**.

To recall arbitrary waveforms

Arbitrary waveform files can be recalled from one of four internal (\Agilent Flash) locations or from an external USB storage device.

When recalling arbitrary waveforms (from an external USB storage device) that were not saved from the oscilloscope, be aware that:

18 Save/Recall (Setups, Screens, Data)

- If the file contains two columns, the second column is automatically chosen.
- If the file contains more than two columns, you are prompted to select which column to load. Up to five columns are parsed by the oscilloscope; columns above the fifth are ignored.
- The oscilloscope uses a maximum of 8192 points for an arbitrary waveform. For more efficient recalls, make sure your arbitrary waveforms are 8192 points or less.

To recall an arbitrary waveform:

- 1 Press [**Save/Recall**] > **Recall** > **Recall**; then, turn the Entry knob to select **Arbitrary Waveform data (*.csv)**.
- 2 Press the softkey in the second position and use the Entry knob to navigate to the file to recall. See "[To navigate storage locations](#)" on page 282.
- 3 Press the **Press to Recall** softkey.

A message indicating whether the recall was successful is displayed.

- 4 If you would like to clear the display, press **Clear Display**.

See Also • "[To edit arbitrary waveforms](#)" on page 261

Recalling Default Setups

- 1 Press the [**Save/Recall**] key.
- 2 In the Save/Recall Menu, press **Default/Erase**.
- 3 In the Default Menu, press one of these softkeys:
 - **Default Setup**— recalls the oscilloscope's default setup. This is the same as pressing the front panel [**Default Setup**] key. See "[Recall the Default Oscilloscope Setup](#)" on page 31.

Some user settings are not changed when recalling the default setup.

- **Factory Default**— recalls the oscilloscope's factory default settings.

You must confirm the recall because there are no user settings that are left unchanged.

Performing a Secure Erase

- 1 Press the [**Save/Recall**] key.
- 2 In the Save/Recall Menu, press **Default/Erase**.
- 3 In the Default menu, press **Secure Erase**.

This performs a secure erase of all non-volatile memory in compliance with National Industrial Security Program Operation Manual (NISPO) Chapter 8 requirements.

You must confirm the secure erase, and the oscilloscope will reboot when finished.

18 Save/Recall (Setups, Screens, Data)



19 Print (Screens)

- To print the oscilloscope's display 289
- To set up network printer connections 290
- To specify the print options 292
- To specify the palette option 293

You can print the complete display, including the status line and softkeys, to a USB printer or a network printer when the DSOXLAN LAN/VGA module is installed.

The Print Configuration Menu is displayed when you press the **[Print]** key. The print option softkeys and the **Press to Print** softkey are ghosted (not available) until a printer is connected.

To print the oscilloscope's display

- 1 Connect a printer. You can:
 - Connect a USB printer to either the USB port on the front panel or the rectangular USB host port on the rear panel.

For the most up-to-date listing of printers that are compatible with the InfiniiVision oscilloscopes, please visit ["www.agilent.com/find/InfiniiVision-printers"](http://www.agilent.com/find/InfiniiVision-printers).
 - Set up a network printer connection. See ["To set up network printer connections"](#) on page 290.
- 2 Press the **[Print]** key on the front panel.
- 3 In the Print Configuration Menu, press the **Print to** softkey; then, turn the Entry knob to select the desired printer.



19 Print (Screens)

- 4 Press the **Options** softkey to select the print options.



See ["To specify the print options"](#) on page 292.

- 5 Press the **Palette** softkey to select the print palette. See ["To specify the palette option"](#) on page 293.
- 6 Press the **Press to Print** softkey.

You can stop printing by pressing the **Cancel Print** softkey.

NOTE

The oscilloscope will print the last menu visited before you pressed the **[Print]** key. Therefore, if you have measurements (Amplitude, Frequency, etc.) showing on the display before you press **[Print]**, the measurements will be shown on the printout.

To print the display showing the Print Configuration Menu at the bottom, press the **[Print]** key twice; then, press the **Press to Print** softkey.

You can also configure the **[Quick Action]** key to print the display. See ["Configuring the \[Quick Action\] Key"](#) on page 311.

See Also • ["Adding an Annotation"](#) on page 312

To set up network printer connections

When the DSOXLAN LAN/VGA module is installed, you can set up network printer connections.

A *network printer* is a printer attached to a computer or print server on the network.

- 1 Press the **[Print]** key on the front panel.

- 2 In the Print Configuration Menu, press the **Print to** softkey; then, turn the Entry knob to select the network printer you want to configure (either #0 or #1).
- 3 Press the **Network Setup** softkey.
- 4 In the Network Printer Setup Menu, press the **Modify** softkey; then, turn the Entry knob to select the network parameter you want to enter.

The setting that must be entered is:

- **Printer Address** – this is the printer or print server's address in one of the following formats:
 - IP address of a network-enabled printer (for example: 192.168.1.100 or 192.168.1.100:650). Optionally, a non-standard port number can be specified following a colon.
 - IP address of a print server followed by the path to the printer (for example: 192.168.1.100/printers/printer-name or 192.168.1.100:650/printers/printer-name).
 - Path to a Windows network printer share (for example: \\server\share).

When the Printer Address is a Windows network printer share, the **Modify** softkey also lets you enter these settings:

- **Network Domain** – this is the Windows network domain name.
- **Username** – this is your login name for the Windows network domain.
- **Password** – this is your login password for the Windows network domain.

To clear an entered password, press the **Clear Password** softkey.

- 5 Use the **Spell**, **Enter**, and **Delete Character** softkeys to enter the network printer settings:
 - **Spell** – press this softkey and turn the entry knob to select the character at the current position.
 - **Enter** – press this softkey to enter characters and move the cursor to the next character position.
 - **Delete Character** – press the **Enter** softkey until the desired character is highlighted; then, press this softkey to delete the character.

NOTE

You can use a connected USB keyboard instead of using the **Spell** (and other) character editing softkeys.

6 Press the **Apply** softkey to make the printer connection.

A message appears to tell you whether the connection was successful.

To specify the print options

In the Print Configuration Menu, press the **Options** softkey to change the following options:

- **Setup Information** – Select this to print oscilloscope setup information on your printout, including vertical, horizontal, trigger, acquisition, math, and display settings.
- **Invert Graticule Colors** – Select this to reduce the amount of black ink it takes to print oscilloscope images by changing the black background to white. **Invert Graticule Colors** is the default mode.



Graticule Not Inverted

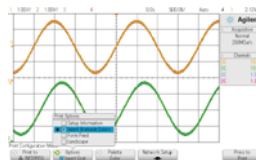

Graticule Inverted

- **Form Feed** – Select this to send a form feed command to the printer after the waveform is printed and before the setup information is printed. Switch **Form Feed** off if you want setup information printed on the same sheet of paper with the waveform. This option only has an effect when the **Setup Information** option is selected. Also, if the amount of setup information will not fit on the same page with the waveform, it will be printed on a new page regardless of the **Form Feed** setting.
- **Landscape** – Select this to print horizontally on the page instead of vertically (portrait mode).

To specify the palette option

In the Print Configuration Menu, press the **Palette** softkey to change the following options.

- **Color** – Select this to print the screen in color.

The oscilloscope's print driver cannot print color images to color laser printers, so the **Color** option is not available when connected to laser printers.

- **Grayscale** – Select this to print the screen in shades of gray rather than in color.

19 Print (Screens)



20 Utility Settings

I/O Interface Settings	295
Setting up the Oscilloscope's LAN Connection	296
File Explorer	299
Setting Oscilloscope Preferences	301
Setting the Oscilloscope's Clock	304
Setting the Rear Panel TRIG OUT Source	304
Performing Service Tasks	305
Configuring the [Quick Action] Key	311
Adding an Annotation	312

This chapter explains oscilloscope utility functions.

I/O Interface Settings

The oscilloscope can be accessed and/or controlled remotely via these I/O interfaces:

- USB device port on the rear panel (square shaped USB port).
- LAN interface when a LAN/VGA module is installed in the rear panel module slot.
- GPIB interface when a GPIB module is installed in the rear panel module slot.

To configure the I/O interfaces:

- 1 On the oscilloscope's front panel, press **[Utility]**.
- 2 In the Utility Menu, press **I/O**.



3 In the I/O Menu, press **Configure**.

- **LAN** – When a DSOXLAN LAN/VGA module is installed, you can use the **LAN Settings** and **LAN Reset** softkeys to configure the LAN interface. See "[Setting up the Oscilloscope's LAN Connection](#)" on page 296.
- **GPIB** – When a DSOXGPIB GPIB module is installed, you can use the **Address** softkey to configure the GPIB address.
- There are no configuration settings for the USB interface.

When an I/O interface is installed, remote control over that interface is always enabled. Also, the oscilloscope can be controlled via multiple I/O interfaces (for example, USB and LAN) at the same time.

- See Also**
- [Chapter 21](#), “Web Interface,” starting on page 315 (when the oscilloscope is connected to a LAN).
 - "[Remote Programming via the Web Interface](#)" on page 321
 - The oscilloscope's *Programmer's Guide*.
 - "[Remote Programming with Agilent IO Libraries](#)" on page 322

Setting up the Oscilloscope's LAN Connection

When the DSOXLAN LAN/VGA module is installed, you can place the oscilloscope on the network and set up its LAN connection. Once that is done, you can use the oscilloscope's web interface or remotely control the oscilloscope via the LAN interface.

The oscilloscope supports methods for automated LAN configuration or manual LAN configuration (see "[To establish a LAN connection](#)" on page 297). It is also possible to set up a point-to-point LAN connection between a PC and the oscilloscope (see "[Stand-alone \(Point-to-Point\) Connection to a PC](#)" on page 298).

Once the oscilloscope is set up on the network, you can use the oscilloscope's web page to view or change its network configuration and access additional settings (like the network password). See [Chapter 21](#), “Web Interface,” starting on page 315.

NOTE

When you connect the oscilloscope to a LAN it is a good practice to limit access to the oscilloscope by setting a password. By default, the oscilloscope is not password protected. See "[Setting a Password](#)" on page 327 to set a password.

NOTE

Any time you modify the oscilloscope's hostname, it breaks the connection between the oscilloscope and the LAN. You need to re-establish communication to the oscilloscope using the new hostname.

To establish a LAN connection

Automatic Configuration

- 1 Press [**Utility**] > I/O.
- 2 Press the **LAN Settings** softkey.
- 3 Press the **Config** softkey; then, turn the Entry knob to select **Automatic**, and press the softkey again to enable it.

If your network supports DHCP or AutoIP, enabling **Automatic** lets the oscilloscope use those services to get its LAN configuration settings

- 4 If your network provides Dynamic DNS, you can enable the **Dynamic DNS** option to let the oscilloscope register its hostname and use the DNS server for name resolution.
- 5 You can enable the **Multicast DNS** option to let the oscilloscope use Multicast DNS for name resolution on small networks without a conventional DNS server.
- 6 Connect the oscilloscope to the local area network (LAN) by inserting the LAN cable into the "LAN" port on the rear panel of the oscilloscope.

In a few moments the oscilloscope will connect to the network automatically.

If the oscilloscope does not automatically connect to the network, press [**Utility**] > I/O > **LAN Reset**. In a few moments the oscilloscope will connect to the network.

Manual Configuration

- 1 Get the oscilloscope's network parameters (host name, IP address, subnet mask, gateway IP, DNS IP, etc.) from your network administrator.
- 2 Press [**Utility**] > I/O.

- 3 Press the **LAN Settings** softkey.
- 4 Press the **Config** softkey; then, turn the Entry knob to select **Automatic**, and press the softkey again to disable it.

If Automatic is not enabled, the oscilloscope's LAN configuration must be set up manually using the **Addresses** and **Host name** softkeys

- 5 Configure the oscilloscope's LAN interface:
 - a Press the **Addresses** softkey.
 - b Use the **Modify** softkey (and the other softkeys and the Entry knob) to enter the IP Address, Subnet Mask, Gateway IP, and DNS IP values. When you are done, go back up in the menu hierarchy.
 - c Press the **Host name** softkey. Use the softkeys and the Entry knob to enter the Host name. When you are done, go back up in the menu hierarchy.
 - d Press the **Apply** softkey.
- 6 Connect the oscilloscope to the local area network (LAN) by inserting the LAN cable into the "LAN" port on the rear panel of the oscilloscope.

Stand-alone (Point-to-Point) Connection to a PC

The following procedure describes how to establish a point-to-point (stand alone) connection to the oscilloscope. This is useful if you want to control the oscilloscope using a laptop computer or a stand-alone computer.

- 1 Press [**Utility**] > I/O.
- 2 Press the **LAN Settings** softkey.
- 3 Press the **Config** softkey; then, turn the Entry knob to select **Automatic**, and press the softkey again to enable it.

If your network supports DHCP or AutoIP, enabling **Automatic** lets the oscilloscope use those services to get its LAN configuration settings

- 4 Connect your PC to the oscilloscope using a cross-over LAN cable such as Agilent part number 5061-0701, available on the web at "www.parts.agilent.com".
- 5 Cycle power on the oscilloscope. Wait until the LAN connection is configured:
 - Press [**Utility**] > I/O and wait until the LAN status shows "configured".

This may take a few minutes.

Now, the instrument is connected, and the instrument's web interface or remote control via LAN may be used.

File Explorer

The File Explorer lets you navigate the oscilloscope's internal file system and the file systems of connected USB storage devices.

From the internal file system, you can load oscilloscope setup files or mask files.

From a connected USB storage device, you can load setup files, mask files, license files, firmware update (*.cab) files, label files, etc. Also, you can delete files on a connected USB storage device.

NOTE

The USB port on the front panel, and the USB port on the rear panel labeled "HOST" are USB Series A receptacles. These are the receptacles to which you can connect USB mass storage devices and printers.

The square receptacle on the rear panel labeled "DEVICE" is provided for controlling the oscilloscope over USB. See the *Programmer's Guide* for more information.

The oscilloscope's internal file system, under "\Agilent Flash", consists of 10 locations for oscilloscope setup files, and four locations for mask files.

To use the File Explorer:

- 1 Press **[Utility] > File Explorer**.
- 2 In the File Explorer Menu, press the softkey in the first position and use the Entry knob to navigate.

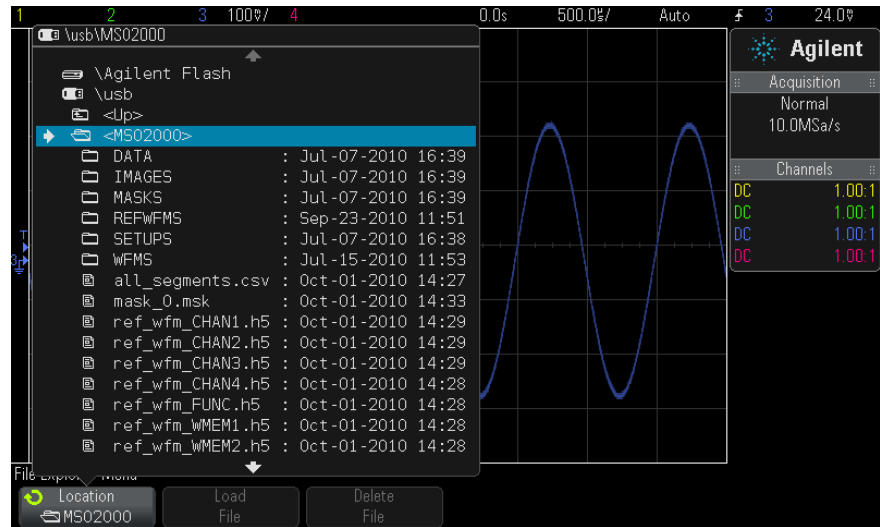

The softkey in the first position can have these labels:

- **Press to go** – when you can push the Entry knob to navigate to a new folder or storage location.
- **Location** – when pointing to a directory that is currently selected.
- **Selected** – when pointing to a file that can be loaded or deleted.

When this label appears, you can press the **Load File** or **Delete File** softkeys to take the action.

Pushing the Entry knob is the same as pressing the **Load File** softkey.

A file that has been deleted from a USB storage device cannot be recovered by the oscilloscope.

Use your PC to create directories on a USB storage device.

USB Storage Devices

Most USB mass storage devices are compatible with the oscilloscope. However, certain devices may be incompatible, and may not be able to be read or written to.

When the USB mass storage device is connected to the oscilloscope's front or rear USB host port, a small four-color circle icon may be displayed briefly as the USB device is read.

You do not need to "eject" the USB mass storage device before removing it. Simply ensure that any file operation you've initiated is done, and remove the USB drive from the oscilloscope's host port.

Do not connect USB devices that identify themselves as hardware type "CD" because these devices are not compatible with the InfiniiVision X-Series oscilloscopes.

If two USB mass storage devices are connected to the oscilloscope, the first one is designated "\usb" and the second one is designated "\usb2".

See Also • [Chapter 18](#), "Save/Recall (Setups, Screens, Data)," starting on page 273

Setting Oscilloscope Preferences

The User Preferences Menu (under **[Utility] > Options > Preferences**) lets you specify oscilloscope preferences.

- ["To choose "expand about" center or ground"](#) on page 301
- ["To disable/enable transparent backgrounds"](#) on page 302
- ["To load the default label library"](#) on page 302
- ["To set up the screen saver"](#) on page 302
- ["To set AutoScale preferences"](#) on page 303

To choose "expand about" center or ground

When you change a channel's volts/division setting, the waveform display can be set to expand (or compress) about the signal ground level or the center of the display.

To set the waveform expansion reference point:

1 Press **[Utility] > Options > Preferences > Expand** and select:

- **Ground**— The displayed waveform will expand about the position of the channel's ground. This is the default setting.

The ground level of the signal is identified by the position of the ground level (⚡) icon at the far-left side of the display.

The ground level will not move when you adjust the vertical sensitivity (volts/division) control.

If the ground level is off screen, the waveform will expand about the top or bottom edge of the screen based on where the ground is off screen.

- **Center**– The displayed waveform will expand about the center of the display.

To disable/enable transparent backgrounds

There is a preference setting for whether measurements, statistics, reference waveform information, and other text displays have transparent or solid backgrounds.

- 1 Press **[Utility] > Options > Preferences**.
- 2 Press **Transparent** to toggle between transparent and solid text display backgrounds.

To load the default label library

See ["To reset the label library to the factory default"](#) on page 141.

To set up the screen saver

The oscilloscope can be configured to turn on a display screen saver when the oscilloscope has been idle for a specified length of time.

- 1 Press **[Utility] > Options > Preferences > Screen Saver** to display the Screen Saver Menu.



- 2 Press the **Saver** softkey to select the screen saver type.

The screen saver can be set to **Off**, to display any of the images shown in the list, or can display a user-defined text string.

If **User** is selected, press the **Spell** softkey to select the first character of the text string. Use the Entry knob to choose a character. Then press the **Enter** softkey to advance to the next character and repeat the process.

NOTE

You can use a connected USB keyboard instead of using the **Spell** (and other) character editing softkeys.

The resultant string is displayed in the "Text =" line above the softkeys.



- 3 Press the **Wait** softkey; then, turn the Entry knob to select the number of minutes to wait before the selected screen saver activates.

When you turn the Entry knob, the number of minutes is displayed on the **Wait** softkey. The default time is 180 minutes (3 hours).

- 4 Press the **Preview** softkey to preview the screen saver you have selected with the **Saver** softkey.
- 5 To view the normal display after the screen saver has started, press any key or turn any knob.

To set AutoScale preferences

- 1 Press [**Utility**] > **Options** > **Preferences** > **AutoScale**.
- 2 In the AutoScale Preferences Menu, you can:

- Press the **Fast Debug** softkey enable/disable this type of autoscale.

When fast debug is enabled, autoscale lets you make quick visual comparisons to determine whether the signal being probed is a DC voltage, ground, or an active AC signal.

Channel coupling is maintained to allow easy viewing of oscillating signals.

- Press the **Channels** softkey and turn the Entry knob to specify the channels to be autoscaled:
 - **All Channels** – The next time you press [**AutoScale**], all channels that meet the requirements of AutoScale will be displayed.

- **Only Displayed Channels** – The next time you press **[AutoScale]**, only the channels that are turned on will be examined for signal activity. This is useful if you only want to view specific active channels after pressing **[AutoScale]**.
- Press the **Acq Mode** softkey and turn the Entry knob to select whether the acquisition mode should be preserved during autoscale:
 - **Normal** – to make the oscilloscope switch to Normal acquisition mode whenever the **[AutoScale]** key is pressed. This is the default mode.
 - **Preserve** – to make the oscilloscope remain in the acquisition mode you have chosen when the **[AutoScale]** key is pressed.

Setting the Oscilloscope's Clock

The Clock Menu lets you set the current date and time of day (24-hour format). This time/date stamp will appear on hardcopy prints and directory information on the USB mass storage device.

To set the date and time, or to view the current date and time:

- 1 Press **[Utility] > Options > Clock**.



- 2 Press the **Year, Month, Day, Hour** or **Minute** softkey; then, rotate the Entry knob to set to the desired number.

The hours are shown in the 24-hour format. So 1:00 PM is hour 13.

The real-time clock only allows selection of valid dates. If a day is selected and the month or year is changed so the day is invalid, the day is automatically adjusted.

Setting the Rear Panel TRIG OUT Source

You can choose the source of the TRIG OUT connector on the rear panel of the oscilloscope:

- 1 Press **[Utility] > Options > Rear Panel**.
- 2 In the Rear Panel Menu, press **Trig Out**; then, turn the Entry knob to select from:
 - **Triggers**– Each time the oscilloscope triggers, a rising edge occurs on TRIG OUT. The rising edge is delayed 30 ns from the oscilloscope's trigger point. The output level is 0-5 V into an open circuit, and 0-2.5 V into 50 Ω . See [Chapter 10](#), “Triggers,” starting on page 143.
 - **Mask**– The pass/fail status is evaluated periodically. When the evaluation of the testing period results in a failure, the trigger output pulses high (+5 V). Otherwise, the trigger output remains at low (0 V). See [Chapter 15](#), “Mask Testing,” starting on page 241.
 - **Waveform Generator Sync Pulse**– All of the waveform generator output functions (except DC, Noise, and Cardiac) have an associated Sync signal:

The Sync signal is a TTL positive pulse that occurs when the waveform rises above zero volts (or the DC offset value).

See [Chapter 17](#), “Waveform Generator,” starting on page 257.

The TRIG OUT connector also provides the User Cal signal. See ["To perform user calibration"](#) on page 306.

Performing Service Tasks

The Service Menu (under **[Utility] > Service**) lets you perform service-related tasks:



- ["To perform user calibration"](#) on page 306
- ["To perform hardware self test"](#) on page 308
- ["To perform front panel self test"](#) on page 309
- ["To display oscilloscope information"](#) on page 309
- ["To display the user calibration status"](#) on page 309

For other information related to oscilloscope maintenance and service, see:

- "To clean the oscilloscope" on page 309
- "To check warranty and extended services status" on page 310
- "To contact Agilent" on page 310
- "To return the instrument" on page 310

To perform user calibration

Perform user-calibration:

- Every two years or after 4000 hours of operation.
- If the ambient temperature is $>10^{\circ}$ C from the calibration temperature.
- If you want to maximize the measurement accuracy.

The amount of use, environmental conditions, and experience with other instruments help determine if you need shorter User Cal intervals.

User Cal performs an internal self-alignment routine to optimize the signal path in the oscilloscope. The routine uses internally generated signals to optimize circuits that affect channel sensitivity, offset, and trigger parameters.

Performing User Cal will invalidate your Certificate of Calibration. If NIST (National Institute of Standards and Technology) traceability is required, perform the "Performance Verification" procedure in the *Agilent InfiniiVision 2000/3000 X-Series Oscilloscopes Service Guide* using traceable sources.

To perform user calibration:

- 1** Disconnect all inputs from the front and rear panels, including the digital channels cable on an MSO, and allow the oscilloscope to warm up before performing this procedure.
- 2** Press the rear-panel CAL button to disable calibration protection.
- 3** Connect short (12 inch maximum) equal length cables to each analog channel's BNC connector on the front of the oscilloscope. You will need two equal-length cables for a 2-channel oscilloscope or four equal-length cables for a 4-channel oscilloscope.

Use 50W RG58AU or equivalent BNC cables when performing User Cal.

For a 2-channel oscilloscope, connect a BNC tee to the equal length cables. Then connect a BNC(f)-to-BNC(f) (also called a barrel connector) to the tee as shown below.

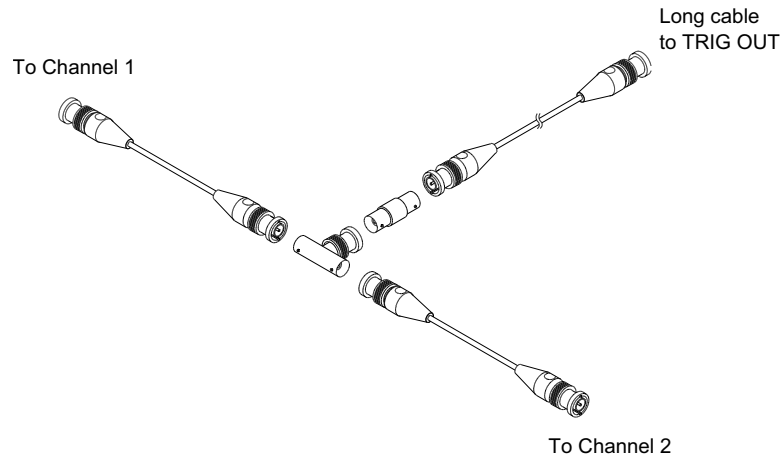

Figure 48 User Calibration cable for 2-channel oscilloscope

For a 4-channel oscilloscope, connect BNC tees to the equal-length cables as shown below. Then connect a BNC(f)-to-BNC(f) (barrel connector) to the tee as shown below.

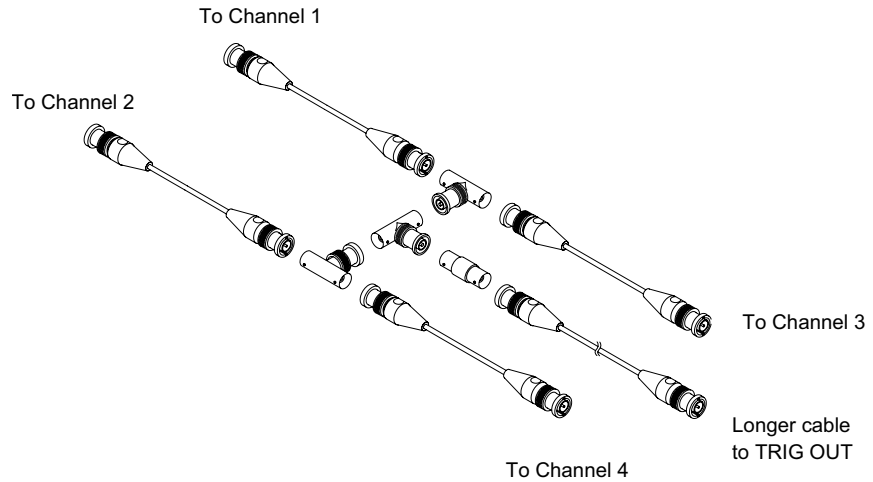

Figure 49 User Calibration cable for 4-channel oscilloscope

- 4 Connect a BNC cable (40 inches maximum) from the TRIG OUT connector on the rear panel to the BNC barrel connector.
- 5 Press the **[Utility]** key; then, press the **Service** softkey.
- 6 Begin the Self Cal by pressing the **Start User Cal** softkey.

To perform hardware self test

Pressing **[Utility] > Service > Hardware Self Test** performs a series of internal procedures to verify that the oscilloscope is operating properly.

It is recommended you run Hardware Self Test:

- After experiencing abnormal operation.
- For additional information to better describe an oscilloscope failure.
- To verify proper operation after the oscilloscope has been repaired.

Successfully passing Hardware Self Test does not guarantee 100% of the oscilloscope's functionality. Hardware Self Test is designed to provide an 80% confidence level that the oscilloscope is operating properly.

To perform front panel self test

Pressing **[Utility] > Service > Front Panel Self Test** lets you test the front panel keys and knobs as well as the oscilloscope display.

Follow the on-screen instructions.

To display oscilloscope information

Press **[Help] > About Oscilloscope** to display information about your oscilloscope:

- Model number.
- Serial number.
- Bandwidth.
- Module installed.
- Software version.
- Installed licenses. See also "[Loading Licenses and Displaying License Information](#)" on page 339.

To display the user calibration status

Pressing **[Utility] > Service > User Cal Status** displays the summary results of the previous User Cal, and the status of probe calibrations for probes that can be calibrated. Note that passive probes do not need to be calibrated, but InfiniiMax probes can be calibrated. For more information about calibrating probes see "[To calibrate a probe](#)" on page 70.

```
Results:
User Cal date:
Change in temperature since last User Cal:
Failure:
Comments:
Probe Cal Status:
```

To clean the oscilloscope

- 1 Remove power from the instrument.
- 2 Clean the external surfaces of the oscilloscope with a soft cloth dampened with a mixture of mild detergent and water.
- 3 Make sure that the instrument is completely dry before reconnecting it to a power source.

To check warranty and extended services status

To learn the warranty status of your oscilloscope:

- 1 Point your web browser to: "www.agilent.com/find/warrantystatus"
- 2 Enter your product's model number and serial number. The system will search for the warranty status of your product and display the results. If the system cannot find your product's warranty status, select **Contact Us** and speak with an Agilent Technologies representative.

To contact Agilent

Information on contacting Agilent Technologies can be found at: "www.agilent.com/find/contactus"

To return the instrument

Before shipping the oscilloscope to Agilent Technologies, contact your nearest Agilent Technologies sales or service office for additional details. Information on contacting Agilent Technologies can be found at: "www.agilent.com/find/contactus"

- 1 Write the following information on a tag and attach it to the oscilloscope.
 - Name and address of owner.
 - Model number.
 - Serial number.
 - Description of service required or failure indication.
- 2 Remove accessories from the oscilloscope.

Only return accessories to Agilent Technologies if they are associated with the failure symptoms.

- 3 Package the oscilloscope.

You can use the original shipping container, or provide your own materials sufficient to protect the instrument during shipping.

- 4 Seal the shipping container securely, and mark it FRAGILE.

Configuring the [Quick Action] Key

The [Quick Action] key lets you perform common, repetitive actions by pressing a single key.

To configure the [Quick Action] key:

- 1 Press [Utility] > **Quick Action** > **Action**; then, select the action that should be performed:
 - **Off** – disables the [Quick Action] key.
 - **Quick Measure All** – displays a popup containing a snapshot of all the single waveform measurements. The **Source** softkey lets you select the waveform source (which also becomes the source selection in the Measurement Menu). See [Chapter 14](#), “Measurements,” starting on page 215.
 - **Quick Print** – prints the current screen image. Press **Settings** to set up the printing options. See [Chapter 19](#), “Print (Screens),” starting on page 289.
 - **Quick Save** – saves the current image, waveform data, or setup. Press **Settings** to set up the save options. See [Chapter 18](#), “Save/Recall (Setups, Screens, Data),” starting on page 273.
 - **Quick Recall** – recalls a setup, mask, or reference waveform. Press **Settings** to set up the recall options. See [Chapter 18](#), “Save/Recall (Setups, Screens, Data),” starting on page 273.
 - **Quick Freeze Display** – freezes the display without stopping running acquisitions or un-freezes the display if currently frozen. For more information, see ["To freeze the display"](#) on page 135.
 - **Quick Trigger Mode** – toggles the trigger mode between Auto and Normal, see ["To select the Auto or Normal trigger mode"](#) on page 180.
 - **Quick Clear Display** – clears the display, see ["To clear the display"](#) on page 134.

Once the [Quick Action] key is configured, you simply press it to perform the selected action.

Adding an Annotation

You can add an annotation to the upper left corner of the oscilloscope's display. The annotation is useful for documentation purposes, to add notes before capturing screens.

To add an annotation:

- 1 On the oscilloscope's front panel, press **[Utility]**.
- 2 In the Utility Menu, press **Annotation**.
- 3 In the Annotation Menu, press **Annotation** to enable the annotation.
- 4 Press **Edit**.
- 5 In the Edit Annotation Menu:

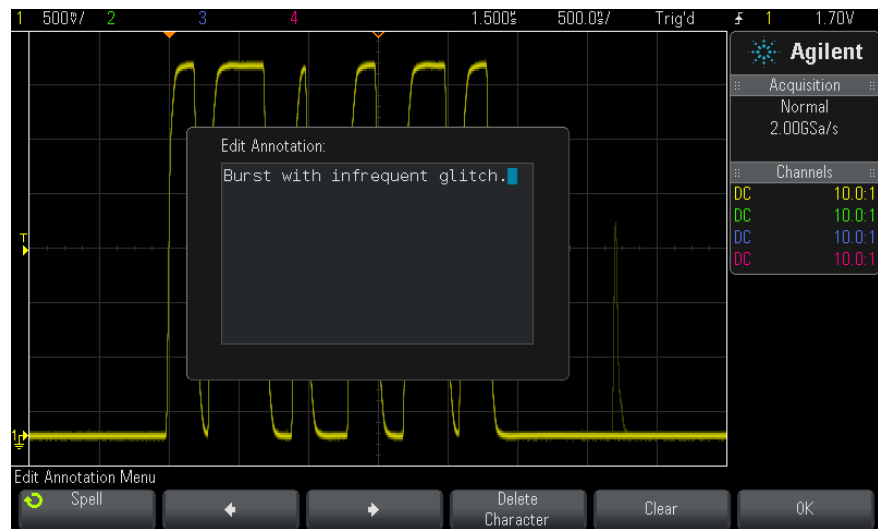

- Use the **Spell**, **←**, **→**, and **Delete Character** softkeys to enter the annotation text:
 - **Spell** – press this softkey and turn the Entry knob to select the character at the current position.
 - **←** – press this softkey to enter characters and move the cursor to the next character position.

- **↩** – press this softkey to enter characters and move the cursor to the previous character position.
- **Delete Character** – press the **↩** or **↪** softkeys until the desired character is highlighted; then, press this softkey to delete the character.

NOTE

You can use a connected USB keyboard instead of using the **Spell** (and other) character editing softkeys.

- Use the **Clear** softkey to delete all annotation characters.
- Press **OK** to save the annotation edits.

6 Press the **Text Color** softkey and turn the Entry knob to select the annotation color.

You can choose white, red, or colors that match analog channels, digital channels, math waveforms, reference waveforms, or markers.

7 Press the **Background** softkey and turn the Entry knob to select the annotation background:

- **Opaque** – the annotation has a solid background.
- **Inverted** – the annotation's foreground and background colors are switched.
- **Transparent** – the annotation has a transparent background.

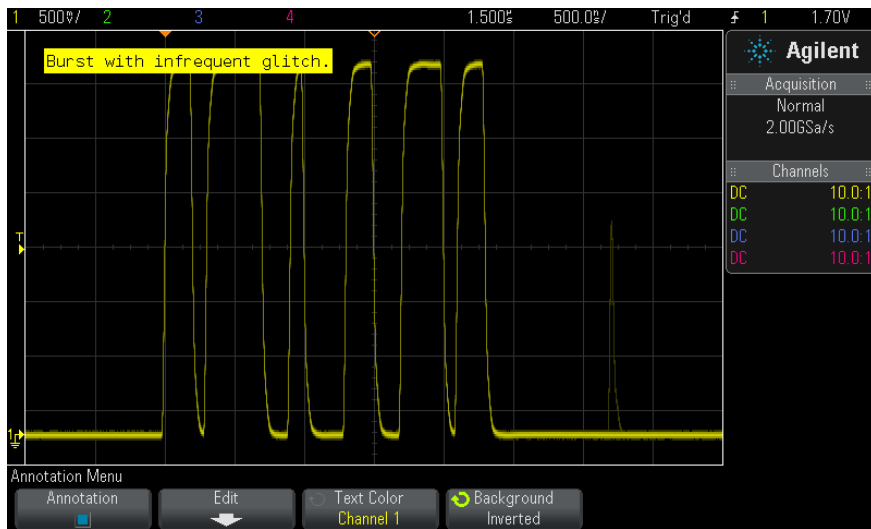

- See Also**
- ["To save BMP or PNG image files"](#) on page 275
 - ["To print the oscilloscope's display"](#) on page 289

21 Web Interface

Accessing the Web Interface	316
Browser Web Control	317
Save/Recall	323
Get Image	325
Identification Function	326
Instrument Utilities	326
Setting a Password	327

When the Agilent InfiniiVision X-Series oscilloscopes have the DSOXLAN LAN/VGA option module installed, you can access the oscilloscope's built-in web server using a Java™-enabled web browser. The oscilloscope's web interface lets you:

- View information about the oscilloscope like its model number, serial number, host name, IP address, and VISA (address) connect string.
- Control the oscilloscope using the Remote Front Panel.
- Send SCPI (Standard Commands for Programmable Instrumentation) remote programming commands via the SCPI Commands applet window.
- Save setups, screen images, waveform data, and mask files.
- Recall setup files, reference waveform data files, or mask files.
- Get screen images and save or print them from the browser.
- Activate the Identification function to identify a particular instrument by causing a message to be displayed or a front panel light to blink.
- View installed options, view firmware versions and install firmware upgrade files, and view calibration status (via the Instrument Utilities page).
- View and modify the oscilloscope's network configuration.



The web interface for InfiniiVision X-Series oscilloscopes also provides help for each of its pages.

Microsoft Internet Explorer is the recommended Web browser for communication and control of the oscilloscope. Other Web browsers may work but are not guaranteed to work with the oscilloscope. The Web browser must be Java-enabled with Sun Microsystems™ Java Plug-in.

Before you can use the web interface, you must place the oscilloscope on the network and set up its LAN connection.

Accessing the Web Interface

To access the oscilloscope's web interface:

- 1 Connect the oscilloscope to your LAN (see ["To establish a LAN connection"](#) on page 297) or establish a point-to-point connection (see ["Stand-alone \(Point-to-Point\) Connection to a PC"](#) on page 298).

It is possible to use a point-to-point connection, but using a normal LAN connection is the preferred method.

- 2 Type the oscilloscope's hostname or IP address in the web browser.

The oscilloscope's web interface Welcome Page is displayed.



Agilent Technologies Oscilloscope

[Support](#) | [Products](#) | [Agilent Site](#)

Another web-enabled instrument from Agilent Technologies

-  Welcome Page
-  Browser Web Control
-  Save/Recall
-  Get Image
-  Instrument Utilities
-  Configure Network
-  Print Page
-  Help with this Page

Welcome to your Web-Enabled Oscilloscope MSO-X 2024A



Information about this Web-Enabled Instrument

Instrument	MSO-X 2024A Oscilloscope
Serial Number	US50210029
Description	Agilent MSO-X 2024A (US50210029)
Hostname	a-mx2024a-10029.cos.agilent.com
IP Address	130.29.70.169
VISA TCP/IP Connect String	TCPIP0::a-mx2024a-10029::INSTR

▼ **Advanced information**
Identification: off on

Use the navigation bar on the left to access your oscilloscope and related information.

© Agilent Technologies, Inc. 2006-2010



Browser Web Control

The web interface's Browser Web Control page gives you access to:

- The Real Scope Remote Front Panel (see ["Real Scope Remote Front Panel"](#) on page 318).
- The Simple Remote Front Panel (see ["Simple Remote Front Panel"](#) on page 319).
- The Browser-Based Remote Front Panel (see ["Browser-Based Remote Front Panel"](#) on page 320).
- The SCPI Command window applet for Remote Programming (see ["Remote Programming via the Web Interface"](#) on page 321).

NOTE

If Java is not installed on your PC, you will be prompted to install the Sun Microsystems Java Plug-in. This plug-in must be installed on the controlling PC for the web interface's Remote Front Panel or Remote Programming operations.

The SCPI Command window is useful for testing commands or entering a few commands interactively. When creating automated programs for controlling the oscilloscope, you will typically use the Agilent IO Libraries from within a programming environment like Microsoft Visual Studio (see "[Remote Programming with Agilent IO Libraries](#)" on page 322).

Real Scope Remote Front Panel

To operate the oscilloscope using the web interface's Real Scope Remote Front Panel:

- 1 Access the oscilloscope's web interface (see "[Accessing the Web Interface](#)" on page 316).
- 2 When the oscilloscope's web interface is displayed, select **Browser Web Control**, then select **Real Scope Remote Front Panel**. After a few seconds the Remote Front Panel appears.
- 3 Click keys or knobs that you would normally press on the oscilloscope's front panel. Drag on edges of knobs to turn them.

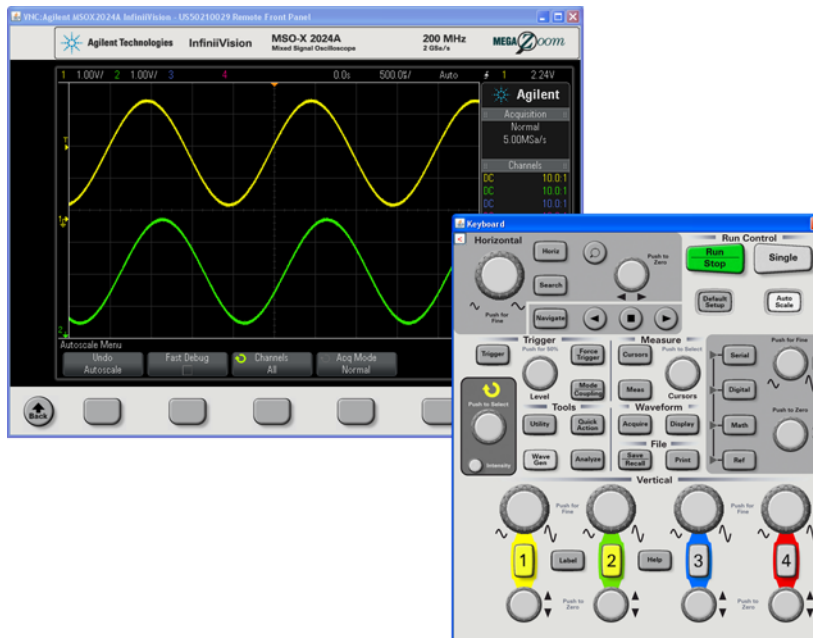

Simple Remote Front Panel

To operate the oscilloscope using the web interface's Simple Remote Front Panel:

- 1 Access the oscilloscope's web interface (see "[Accessing the Web Interface](#)" on page 316).
- 2 When the oscilloscope's web interface is displayed, select **Browser Web Control**, then select **Simple Remote Front Panel**. After a few seconds the Remote Front Panel appears.
- 3 Use the Main Menu and the Function Keys to control the oscilloscope. To view Quick Help, right-click on a softkey.

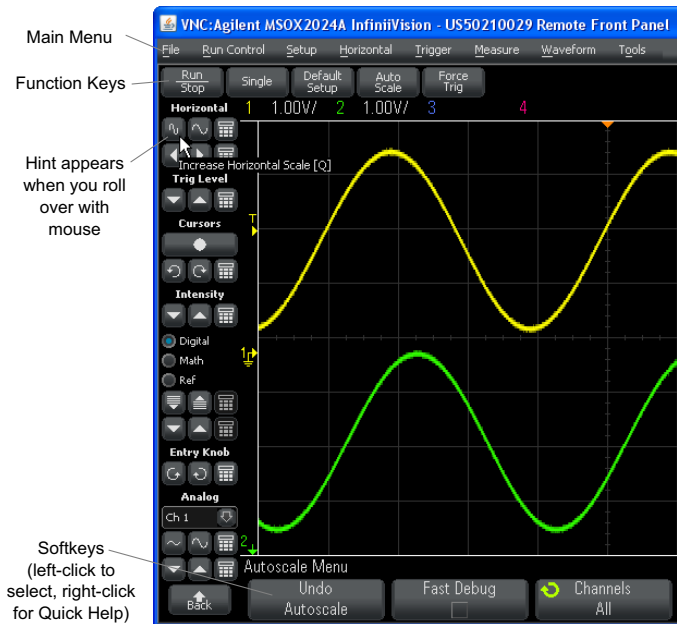

Scrolling and Monitor Resolution

When using a monitor resolution of 800 x 600 or less on the remote computer, you need to scroll to access the full remote front panel. To display the remote front panel without scroll bars, use a monitor resolution greater than 800 x 600 on your computer's display.

Browser-Based Remote Front Panel

To operate the oscilloscope using the web interface's Browser-Based Remote Front Panel:

- 1 Access the oscilloscope's web interface (see "[Accessing the Web Interface](#)" on page 316).
- 2 When the oscilloscope's web interface is displayed, select **Browser Web Control**, then select **Browser-Based Remote Front Panel**. After a few seconds the Remote Front Panel appears.
- 3 Click keys or knobs that you would normally press on the oscilloscope's front panel. Buttons have been added for turning knobs.

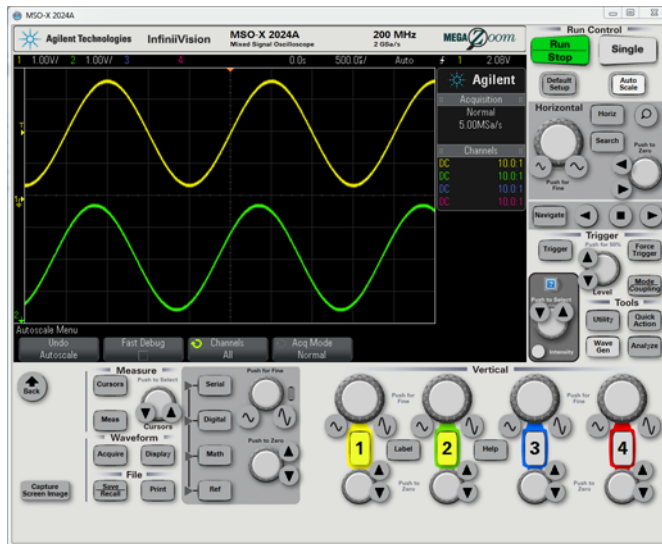

Remote Programming via the Web Interface

To send remote programming commands to the oscilloscope via the SCPI Commands applet window:

- 1 Access the oscilloscope's web interface (see "[Accessing the Web Interface](#)" on page 316).
- 2 When the oscilloscope's web interface is displayed, select **Browser Web Control**, then select **Remote Programming**.

The SCPI Commands applet appears within the browser web page.

Agilent Technologies Oscilloscope

Remote Programming

If you press the 'SCPI Commands...' button below, you can send remote programming commands directly to your instrument. For more information about the commands, see the [Programming Commands Quick Reference](#).

Clear Commands Options

Command

*IDN? Send

```

** Successfully connected to Agilent MSOX2024A InfiniiVision - US50210029 **
> *IDN?
< AGILENT TECHNOLOGIES,MSO-X 2024A,US50210029,01.20.2011050300

```

Remote Programming with Agilent IO Libraries

While the SCPI Commands applet window lets you enter and remote programming commands, remote programming for automated test and data acquisition is typically done using the Agilent IO Libraries, which are separate from the instrument's web interface.

The Agilent IO Libraries let a controller PC communicate with Agilent InfiniiVision oscilloscopes via their USB, LAN (when the LAN/VGA option module is installed), or GPIB (when the GPIB option module is installed) interfaces.

The Agilent IO Libraries Suite connectivity software enables communication over these interfaces. You can download the Agilent IO Libraries Suite from "www.agilent.com/find/iolib".

Information about controlling the oscilloscope through remote commands is contained in the *Programmer's Guide*, which is included on the documentation CD supplied with this oscilloscope. You can also access this document on the Agilent web site.

For more information about connecting to the oscilloscope, refer to the *Agilent Technologies USB/LAN/GPIB Interfaces Connectivity Guide*. For a printable electronic copy of the *Connectivity Guide*, direct your Web browser to "www.agilent.com" and search for "Connectivity Guide".

Save/Recall

You can save setup files, screen images, waveform data files, or mask files to your PC via the oscilloscope's web interface (see "[Saving Files via the Web Interface](#)" on page 323).

You can recall setup files, reference waveform data files, or mask files from your PC via the oscilloscope's web interface (see "[Recalling Files via the Web Interface](#)" on page 324).

Saving Files via the Web Interface

To save setup files, screen images, waveform data, Lister data, or mask files to your PC via the oscilloscope's web interface:

- 1 Access the oscilloscope's web interface (see "[Accessing the Web Interface](#)" on page 316).
- 2 When the oscilloscope's web interface is displayed, select the **Save/Recall** tab from the left side of the Welcome screen.
- 3 Click the **Save** link.
- 4 On the Save page:
 - a Enter the name of the file you are saving to.
 - b Select the format.

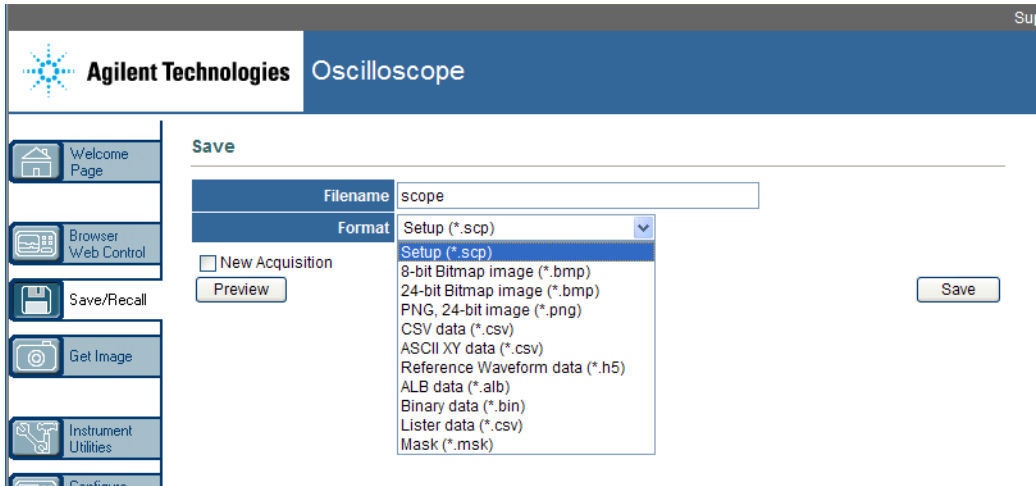

You can click **Preview** to view the oscilloscope's current screen image. When previewing, you can use the **New Acquisition** check box to force a new acquisition before the preview.

With some formats, you can click **Save Setup Info** to save setup information to an ASCII .txt format file.

c Click **Save**.

The current acquisition is saved.

d In the File Download dialog, click **Save**.

e In the Save As dialog, navigate to the folder where you want to save the file; then, click **Save**.

Recalling Files via the Web Interface

To recall setup files, reference waveform data files, or mask files from your PC via the oscilloscope's web interface:

- 1 Access the oscilloscope's web interface (see "[Accessing the Web Interface](#)" on page 316).
- 2 When the oscilloscope's web interface is displayed, select the **Save/Recall** tab from the left side of the Welcome screen.
- 3 Click the **Recall** link.

- 4 On the Recall page:
 - a Click **Browse...**
 - b In the "Choose file" dialog, select the file you want to recall; then, click **Open**.
 - c When recalling reference waveform data files, select the **To Reference Waveform** location.

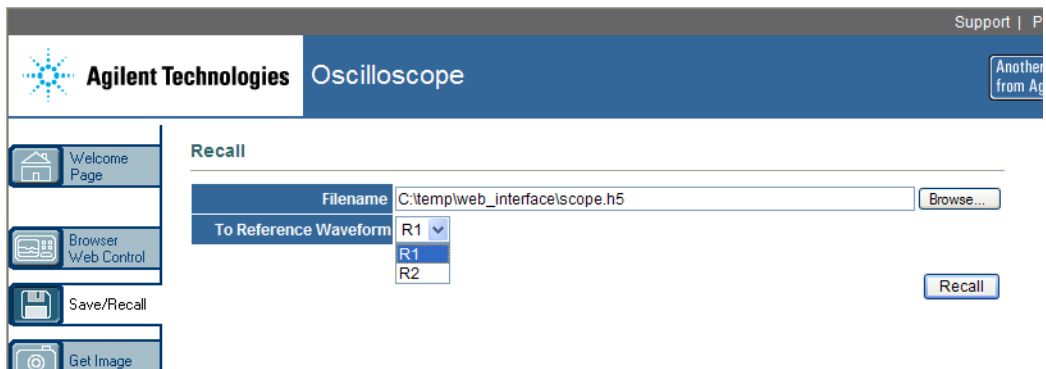

- d Click **Recall**.

Get Image

To save (or print) the oscilloscope's display from the web interface:

- 1 Access the oscilloscope's web interface (see "[Accessing the Web Interface](#)" on page 316).
- 2 When the oscilloscope's web interface is displayed, select the **Get Image** tab from the left side of the Welcome screen. After a delay of several seconds, the oscilloscope's screen image will be displayed.
- 3 Right-click on the image and select **Save Picture As...** (or **Print Picture...**).
- 4 Select a storage location for the image file and click **Save**.

Identification Function

The Identification web interface feature is useful when trying to locate a specific instrument in a rack of equipment.

- 1 Access the oscilloscope's web interface (see "Accessing the Web Interface" on page 316).
- 2 When the oscilloscope's web interface Welcome Page is displayed, select the Identification **on** radio button.

An "Identify" message is displayed on the oscilloscope; you can either select Identification **off** or press the **OK** softkey on the oscilloscope to continue.

Support | Products | Agilent Site

Agilent Technologies Oscilloscope

Another web-enabled instrument from Agilent Technologies

Welcome Page

Welcome to your
Web-Enabled Oscilloscope
MSO-X 2024A

Browser Web Control

Save/Recall

Get Image

Instrument Utilities

Configure Network

Print Page

Help with this Page

Information about this Web-Enabled Instrument

Instrument	MSO-X 2024A Oscilloscope
Serial Number	US50210029
Description	Agilent MSO-X 2024A (US50210029)
Hostname	a-mx2024a-10029.cos.agilent.com
IP Address	130.29.70.169
VISA TCP/IP Connect String	TCP/IP0:a-mx2024a-10029::INSTR

Advanced information Identification: off on

Use the navigation bar on the left to access your oscilloscope and related information.

© Agilent Technologies, Inc. 2006-2010

Identification option

Instrument Utilities

The Instrument Utilities page of the web interface lets you:

- View installed options.

- View firmware versions.
- Install firmware upgrade files.
- View calibration status.

You can select these capabilities via a drop-down menu.

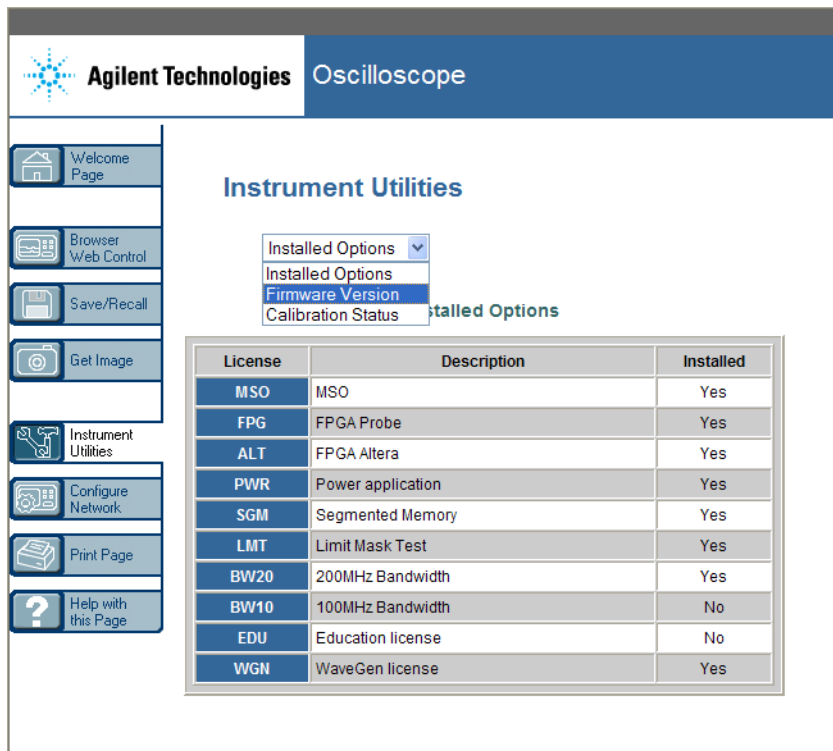

The screenshot shows the Agilent Technologies Oscilloscope web interface. The top navigation bar includes the Agilent logo and the text 'Agilent Technologies Oscilloscope'. A left-hand sidebar contains several utility buttons: Welcome Page, Browser Web Control, Save/Recall, Get Image, Instrument Utilities (highlighted), Configure Network, Print Page, and Help with this Page. The main content area is titled 'Instrument Utilities' and features a dropdown menu labeled 'Installed Options' with a list of options: 'Installed Options', 'Firmware Version', and 'Calibration Status'. Below the dropdown is a table with the following data:

License	Description	Installed
MSO	MSO	Yes
FPG	FPGA Probe	Yes
ALT	FPGA Altera	Yes
PWR	Power application	Yes
SGM	Segmented Memory	Yes
LMT	Limit Mask Test	Yes
BW20	200MHz Bandwidth	Yes
BW10	100MHz Bandwidth	No
EDU	Education license	No
WGN	WaveGen license	Yes

Setting a Password

Whenever you connect the oscilloscope to a LAN, it is good practice to set a password. The password prevents someone from remotely accessing the oscilloscope via a Web browser and changing parameters. Remote users can still view the Welcome screen, view network status, etc., but they can't operate the instrument or change its setup without the password.

To set a password:

- 1 Access the oscilloscope's web interface (see "Accessing the Web Interface" on page 316).
- 2 When the oscilloscope's web interface is displayed, select the Configure Network tab from the instrument's Welcome page.
- 3 Click the **Modify Configuration** button.

The screenshot shows the Agilent Technologies Oscilloscope web interface. The left sidebar contains several navigation options: Welcome Page, Browser Web Control, Save/Recall, Get Image, Instrument Utilities, **Configure Network** (selected), Print Page, and Help with this Page. The main content area displays the 'Current Network Configuration' page, which includes a 'Modify Configuration' button and a table of network parameters.

Parameter	Currently in use
Configuration mode	Automatic
Dynamic DNS	ON
NetBIOS	ON
Multicast DNS	ON
Multicast DNS Description	Agilent MSO-X 2024A InfiniiVision - US50210029
IP Address	130.29.70.169
Subnet Mask	255.255.248.0
Default Gateway	130.29.64.1
DHCP Server	130.29.64.128
DNS Server	130.29.64.128
Hostname	a-mx2024a-10029
Domain	cos.agilent.com
LAN KeepAlive Timeout	1800
Media Sense	ON
GPIB Control	OFF
GPIB Address	7
USB Control	ON
LAN Control	ON

- 4 Enter your desired password, and click **Apply Changes**.

Support | P

Agilent Technologies Oscilloscope

Another from Ag

Welcome Page

Browser Web Control

Save/Recall

Get Image

Instrument Utilities

Configure Network

Print Page

Help with this Page

Modify Network Configuration

Undo Changes Factory Defaults Apply Changes

Parameter	Configured Value	Edit Configuration
IP Settings may be configured using the following:		
Automatic	ON	<input type="radio"/> OFF <input checked="" type="radio"/> ON
IP Settings to use in non automatic mode:		
IP Address	169.254.254.254	<input type="text" value="169.254.254.254"/>
Subnet Mask	255.255.248.0	<input type="text" value="255.255.248.0"/>
Default Gateway	169.254.254.254	<input type="text" value="169.254.254.254"/>
Domain name and name service settings:		
DNS Server	0.0.0.0	<input type="text" value="0.0.0.0"/>
Hostname	a-mx2024a-10029	<input type="text" value="a-mx2024a-10029"/> *
Dynamic DNS	ON	<input type="radio"/> OFF <input checked="" type="radio"/> ON
Multicast DNS	ON	<input type="radio"/> OFF <input checked="" type="radio"/> ON
Multicast DNS Description	Agilent MSO-X 2024A InfiniiVision - US50210029	<input type="text" value="Agilent MSO-X 2024A InfiniiVision -"/>
Other settings:		
KeepAlive Timeout (sec)	1800	<input type="text" value="1800"/>
Description	Agilent MSO-X 2024A (US50210029)	<input type="text" value="Agilent MSO-X 2024A (US5021002)"/> *
Password		<input type="text" value="Agilent"/> → Enter password
GPIB Address	7	<input type="text" value="7"/>

*Set to blank for factory default value

When accessing the password protected oscilloscope, the user name is the IP address of the oscilloscope.

To reset the password

Do one of these things to reset the password:

- Using the keys on the front panel of the oscilloscope, press **[Utility] > I/O > LAN Reset**.
- Using the web browser select the **Configure Network** tab, select **Modify Configuration**, erase the Password, and select **Apply Changes**.



22 Reference

Specifications and Characteristics	331
Measurement Category	331
Environmental Conditions	333
Probes and Accessories	334
Loading Licenses and Displaying License Information	339
Software and Firmware Updates	341
Binary Data (.bin) Format	342
CSV and ASCII XY files	348
Acknowledgements	350

Specifications and Characteristics

Please see the InfiniiVision oscilloscope data sheets for complete, up-to-date specifications and characteristics. To download a data sheet, please visit: "www.agilent.com/find/3000X-Series"

Then, select the **Library** tab, followed by **Specifications**.

Or, go to the Agilent home page at "www.agilent.com" and search for "3000 X-Series oscilloscopes data sheet".

To order a data sheet by phone, please contact your local Agilent office. The complete list is available at: "www.agilent.com/find/contactus".

Measurement Category

- "[Oscilloscope Measurement Category](#)" on page 332
- "[Measurement Category Definitions](#)" on page 332
- "[Transient Withstand Capability](#)" on page 333



Oscilloscope Measurement Category

The InfiniiVision oscilloscopes are intended to be used for measurements in Measurement Category I.

WARNING

Use this instrument only for measurements within its specified measurement category.

Measurement Category Definitions

Measurement category I is for measurements performed on circuits not directly connected to MAINS. Examples are measurements on circuits not derived from MAINS, and specially protected (internal) MAINS derived circuits. In the latter case, transient stresses are variable; for that reason, the transient withstand capability of the equipment is made known to the user.

Measurement category II is for measurements performed on circuits directly connected to the low voltage installation. Examples are measurements on household appliances, portable tools and similar equipment.

Measurement category III is for measurements performed in the building installation. Examples are measurements on distribution boards, circuit-breakers, wiring, including cables, bus-bars, junction boxes, switches, socket-outlets in the fixed installation, and equipment for industrial use and some other equipment, for example, stationary motors with permanent connection to the fixed installation.

Measurement category IV is for measurements performed at the source of the low-voltage installation. Examples are electricity meters and measurements on primary overcurrent protection devices and ripple control units.

Transient Withstand Capability

CAUTION

Maximum input voltage at analog inputs

CAT I 300 Vrms, 400 Vpk; transient overvoltage 1.6 kVpk

50Ω input: 5 Vrms Input protection is enabled in 50 Ω mode and the 50 Ω load will disconnect if greater than 5 Vrms is detected. However the inputs could still be damaged, depending on the time constant of the signal. The 50 Ω input protection only functions when the oscilloscope is powered on.

With 10073C 10:1 probe: CAT I 500 Vpk, CAT II 400 Vpk

With N2862A or N2863A 10:1 probe: 300 Vrms

CAUTION

Maximum input voltage at digital channels

±40 V peak CAT I; transient overvoltage 800 Vpk

Environmental Conditions

Environment	Indoor use only.
Ambient temperature	Operating 0 °C to +55 °C; non-operating –40 °C to +71 °C
Humidity	Operating: Up to 80% RH at or below +40 °C. Up to 45% RH up to +50 °C. Non-operating: Up to 95% RH up to +40 °C. Up to 45% RH up to +50 °C.
Altitude	Operating and non-operating to 4,000 m (13,123 ft)
Overvoltage Category	This product is intended to be powered by MAINS that comply to Overvoltage Category II, which is typical of cord-and-plug connected equipment.
Pollution Degree	The InfiniiVision 2000/3000 X-Series oscilloscopes may be operated in environments of Pollution Degree 2 (or Pollution Degree 1).

Pollution Degree Definitions	<p>Pollution Degree 1: No pollution or only dry, non-conductive pollution occurs. The pollution has no influence. Example: A clean room or climate controlled office environment.</p> <p>Pollution Degree 2. Normally only dry non-conductive pollution occurs. Occasionally a temporary conductivity caused by condensation may occur. Example: General indoor environment.</p> <p>Pollution Degree 3: Conductive pollution occurs, or dry, non-conductive pollution occurs which becomes conductive due to condensation which is expected. Example: Sheltered outdoor environment.</p>
------------------------------	--

Probes and Accessories

This section lists the probes and accessories that are compatible with the 3000 X-Series oscilloscopes.

- ["Passive Probes"](#) on page 335
- ["Single-Ended Active Probes"](#) on page 335
- ["Differential Probes"](#) on page 336
- ["Current Probes"](#) on page 337
- ["Accessories Available"](#) on page 338

AutoProbe Interface

Most Agilent single-ended active, differential, and current probes are compatible with the AutoProbe interface. Active probes that do not have their own external power supply require substantial power from the AutoProbe interface.

In the following tables, for AutoProbe interface compatible probes, "Quantity Supported" indicates the maximum number of each type of active probe that can be connected to the oscilloscope.

If too much current is drawn from the AutoProbe interface, an error message will be displayed, indicating that you must momentarily disconnect all probes to reset the AutoProbe interface, then connect only the supported quantity of active probes.

See Also

For more information on probes and accessories, see ["www.agilent.com"](http://www.agilent.com) for:

- ["Probes and Accessories Selection Guide \(5989-6162EN\)"](#)
- ["5000, 6000, and 7000 Series InfiniiVision Oscilloscope Probes and Accessories Data Sheet \(5968-8153EN\)"](#)

Passive Probes

All InfiniiVision oscilloscopes recognize passive probes such as the N2862A/B, N2863A/B, N2889A, N2890A, 10073C, 10074C, and 1165A. These probes have a pin on their connector that connects to the ring around the oscilloscope's BNC connector. Therefore, the oscilloscope will automatically set the attenuation factor for recognized Agilent passive probes.

Passive probes that do not have a pin that connects to the ring around the BNC connector will not be recognized by the oscilloscope, and you must set the probe attenuation factor manually. See ["To specify the probe attenuation"](#) on page 69.

The following passive probes can be used with the InfiniiVision 3000 X-Series oscilloscopes. Any combination of passive probes can be used.

Table 6 Passive Probes

Model	Description
1165A	Passive probe, 10:1, 600 MHz, 1.5 m
10070C/D	Passive probe, 1:1 20 MHz, 1.5 m
10073C	Passive probe, 10:1, 500 MHz, 1.5 m
10074C	Passive probe, 10:1, 150 MHz, 1.5 m
10076A/B	Passive probe, 100:1, 4 kV, 250 MHz
N2771A/B	Passive probe, 1000:1, 30 kV, 50 MHz
N2862A/B	Passive probe, 10:1, 150 MHz, 1.2 m
N2863A/B	Passive probe, 10:1, 300 MHz, 1.2 m
N2889A	Passive probe, 10:1/1:1, 350 MHz, 1.2 m
N2890A	Passive probe, 10:1, 500 MHz, 1.2 m

Single-Ended Active Probes

The following single-ended active probes can be used with the InfiniiVision 3000 X-Series oscilloscopes.

Table 7 Active Probes

Model	Description	Quantity Supported ¹
1130A	1.5 GHz InfiniiMax amplifier, requires one or more InfiniiMax probe heads: E2675A, E2668A, E2669A	2
1131A	InfiniiMax 3.5 GHz probe	2
1132A	InfiniiMax 5 GHz probe	2
1134A	InfiniiMax 7 GHz probe	2
1156A	Active probe, 1.5 GHz	4
1157A	Active probe, 2.5 GHz	4
1158A	Active probe, 4 GHz	4
N2744A	T2A probe interface adapter	Unknown, depends on probes connected
N2795A	Active probe, 1 GHz with AutoProbe interface	2
N2796A	Active probe, 2 GHz with AutoProbe interface	2
¹ See "AutoProbe Interface" on page 334.		

Differential Probes

The following differential probes can be used with the InfiniiVision 3000 X-Series oscilloscopes.

Table 8 Differential Probes

Model	Description	Quantity Supported ¹
1141A	Active differential probe, 200 MHz, 200 VDC + peak AC max (requires 1142A power supply)	
1144A	Active probe, 800 MHz (requires 1142A power supply)	
1145A	Active probe, 750 MHz 2-ch (requires 1142A power supply)	

Table 8 Differential Probes (continued)

Model	Description	Quantity Supported ¹
N2772A	Active differential probe, 20 MHz, 1.2 kVDC + peak AC max (requires N2773A power supply)	
N2790A	High-voltage differential probe, 50:1 or 500:1 (switchable), 100 MHz with AutoProbe interface	4
N2791A	High-voltage differential probe, 25 MHz, +/-700 V, 1 MOhm termination, 10:1 or 100:1 (switchable)	
N2792A	Differential probe, 200 MHz 10:1, 50 Ohm termination	
N2793A	Differential probe, 800 MHz 10:1, +/-15 V, 50 Ohm termination	
N2891A	70 MHz, 7 kV high-voltage differential probe	
¹ See "AutoProbe Interface" on page 334.		

Current Probes

The following current probes can be used with the InfiniiVision 3000 X-Series oscilloscopes.

Table 9 Current Probes

Model	Description	Quantity Supported ¹
1146A	Current probe, 100 kHz, 100 A, AC/DC	
1147A	Current probe, 50 MHz, 15 A, AC/DC with AutoProbe interface	2
N2774A	(Obsolete, replaced by N2782A) with N2775A power supply	
N2780A	Current probe, 2 MHz, 500 A, AC/DC (use with N2779A power supply)	
N2781A	Current probe, 10 MHz, 150 A, AC/DC (use with N2779A power supply)	
N2782A	Current probe, 50 MHz, 30 A, AC/DC (use with N2779A power supply)	
N2783A	Current probe, 100 MHz, 30 A, AC/DC (use with N2779A power supply)	
N2893A	Current probe, 100 MHz, 15 A, AC/DC with AutoProbe interface	2

22 Reference

Table 9 Current Probes (continued)

Model	Description	Quantity Supported ¹
¹ See "AutoProbe Interface" on page 334.		

Accessories Available

In addition to passive probes ("Passive Probes" on page 335), single-ended active probes ("Single-Ended Active Probes" on page 335), differential probes ("Differential Probes" on page 336), and current probes ("Current Probes" on page 337), the following accessories are available for the InfiniiVision 3000 X-Series oscilloscopes.

Table 10 Accessories Available for InfiniiVision 3000 X-Series Oscilloscopes

Model/Part #	Description
DSOXLAN	LAN/VGA connection module
DSOXGPIB	GPIB connection module
N6456A	Rack mount kit
N6457A	Soft carrying case and front panel cover
N2786A	2-leg probe positioner
N2787A	3D probe positioner
1180CZ	Testmobile
N6459A	Hardcopy user's guide
various	Front panel overlays - see "Front Panel Overlays for Different Languages" on page 42.
N6450-60001	16-channel logic probe and accessory kit (standard with MSO models and with MSO upgrade)
01650-61607	Logic cable and terminator (40 pin to 40 pin MSO cable)

You can find these items at "www.agilent.com" or at "www.parts.agilent.com".

For information on more probes and accessories, see "www.agilent.com" for:

- "[Probes and Accessories Selection Guide \(5989-6162EN\)](#)"
- "[5000, 6000, and 7000 Series InfiniiVision Oscilloscope Probes and Accessories Data Sheet \(5968-8153EN\)](#)"

Loading Licenses and Displaying License Information

License files are loaded from a USB storage device using the File Explorer (see "[File Explorer](#)" on page 299).

License information is displayed with other oscilloscope information (see "[To display oscilloscope information](#)" on page 309).

For more information about the licenses and other oscilloscope options available, see:

- "[Licensed Options Available](#)" on page 339
- "[Other Options Available](#)" on page 341
- "[Upgrading to an MSO](#)" on page 341

Licensed Options Available

The following licensed options can be easily installed without returning the oscilloscope to a Service Center. See data sheets for details.

Table 11 Licensed Options Available

License	Description	After purchase model number, notes
ADVMATH	Advanced Math Measurements.	Order DSOX3ADVMATH.
AERO	MIL-STD-1553 and ARINC 429 Serial Triggering and Analysis.	Order DSOX3AERO.
AUDIO	Audio Serial Triggering and Analysis (I2S).	Order DSOX3AUDIO.
AUTO	Automotive Serial Triggering and Analysis (CAN,LIN).	Order DSOX3AUTO.

22 Reference

Table 11 Licensed Options Available (continued)

License	Description	After purchase model number, notes
COMP	Computer Serial Triggering and Analysis (RS232/422/485/UART). Provides trigger and decode capability for many UART (Universal Asynchronous Receiver/Transmitter) protocols including RS232 (Recommended Standard 232).	Order DSOX3COMP.
DVM	Digital Voltmeter Provides provides 3-digit voltage and 5-digit frequency measurements using any analog channel.	Order DSOXDVM.
EDK	Educator's Kit Provides training signals on the oscilloscope's Demo terminals and a lab guide/tutorial for education environments.	Order DSOXEDK.
EMBD	Embedded Serial Triggering and Analysis (I2C, SPI).	Order DSOX3EMBD.
FLEX	FlexRay Triggering and Analysis.	Order DSOX3FLEX.
MASK	Mask Limit Test Lets you create a mask and test waveforms to determine whether they comply to the mask.	Order DSOX3MASK.
mem4M	Memory Upgrade. It shows the total memory depth (4 Mpts interleaved).	Order DSOX3MEMUP.
MSO	Mixed Signal Oscilloscope (MSO). Upgrade a DSO to an MSO. Adds 16 digital channels. You do not have to install any hardware.	Order DSOX3MSO for 500 MHz and lower bandwidth models or DSOXPERFMSO for 1 GHz bandwidth models. The digital probe cable kit is supplied with the MSO license.
PWR	Power Measurement and Analysis.	Order DSOX3PWR. You can find the <i>DSOX3PWR Power Measurement Application User's Guide</i> at " www.agilent.com/find/3000X-Series-manual " or on the Documentation CD.
SGM	Segmented Memory. Lets you capture infrequent or burst signals with great resolution by eliminating the capture of your signal's "inactivity".	Order DSOX3SGM.
VID	Extended Video Triggering and Analysis.	Order DSOX3VID.

Table 11 Licensed Options Available (continued)

License	Description	After purchase model number, notes
WAVEGEN	Waveform Generator.	Order DSOX3WAVEGEN.

Other Options Available

Table 12 Calibration Option

Option	Order
A6J	ANSI Z540 Compliant Calibration

Upgrading to an MSO

A license can be installed to activate the digital channels of an oscilloscope that was not originally ordered as a mixed-signal oscilloscope (MSO). A mixed signal oscilloscope has analog channels plus 16 time-correlated digital timing channels.

For information about upgrading your oscilloscope through licensing, contact your local Agilent Technologies representative or see "www.agilent.com/find/3000X-Series".

Software and Firmware Updates

From time to time Agilent Technologies releases software and firmware updates for its products. To search for firmware updates for your oscilloscope, direct your web browser to "www.agilent.com/find/3000X-Series-sw".

To view the currently installed software and firmware press **[Help] > About Oscilloscope**.

Once you have downloaded a firmware update file, you can place it on a USB storage device and load the file using File Explorer (see "[File Explorer](#)" on page 299), or you can use the Instrument Utilities page of the oscilloscope's web interface (see "[Instrument Utilities](#)" on page 326).

Binary Data (.bin) Format

The binary data format stores waveform data in binary format and provides data headers that describe that data.

Because the data is in binary format, the size of the file is approximately 5 times smaller than the ASCII XY format.

If more than one source is on, all displayed sources will be saved, except math functions.

When using segmented memory, each segment is treated as a separate waveform. All segments for a channel are saved, then all segments of the next (higher numbered) channel are saved. This continues until all displayed channels are saved.

When the oscilloscope is in the Peak Detect acquisition mode, the minimum and maximum value waveform data points are saved to the file in separate waveform buffers. The minimum value data points are saved first; then, the maximum value data points are saved.

BIN data - using segmented memory

When saving all segments, each segment has its own waveform header (see "[Binary Header Format](#)" on page 343).

In BIN file format, data are presented as follows:

- Channel 1 data (all segments)
- Channel 2 data (all segments)
- Channel 3 data (all segments)
- Channel 4 data (all segments)
- Digital channel data (all segments)
- Math waveform data (all segments)

When not saving all segments, the number of waveforms is equivalent to the number of active channels (including math and digital channels, with up to seven waveforms for each digital pod). When saving all segments, the number of waveforms is equal to the number of active channels multiplied by the number of segments acquired.

Binary Data in MATLAB

Binary data from an InfiniiVision oscilloscope can be imported to The MathWorks MATLAB®. You can download the appropriate MATLAB functions from the Agilent Technologies web site at ["www.agilent.com/find/3000X-Series-examples"](http://www.agilent.com/find/3000X-Series-examples).

Agilent provides the .m files, which need to be copied into the work directory for MATLAB. The default work directory is C:\MATLAB7\work.

Binary Header Format

File Header There is only one file header in a binary file. The file header consists of the following information.

Cookie	Two byte characters, AG, that indicate the file is in the Agilent Binary Data file format.
Version	Two bytes that represent the file version.
File Size	A 32-bit integer that is the number of bytes that are in the file.
Number of Waveforms	A 32-bit integer that is the number of waveforms that are stored in the file.

Waveform Header It is possible to store more than one waveform in the file, and each waveform stored will have a waveform header. When using segmented memory, each segment is treated as a separate waveform. The waveform header contains information about the type of waveform data that is stored following the waveform data header.

Header Size	A 32-bit integer that is the number of bytes in the header.
Waveform Type	A 32-bit integer that is the type of waveform stored in the file: <ul style="list-style-type: none"> • 0 = Unknown. • 1 = Normal. • 2 = Peak Detect. • 3 = Average. • 4 = Not used in InfiniiVision oscilloscopes. • 5 = Not used in InfiniiVision oscilloscopes. • 6 = Logic.

Number of Waveform Buffers	A 32-bit integer that is the number of waveform buffers required to read the data.
Points	A 32-bit integer that is the number of waveform points in the data.
Count	A 32-bit integer that is the number of hits at each time bucket in the waveform record when the waveform was created using an acquisition mode like averaging. For example, when averaging, a count of four would mean every waveform data point in the waveform record has been averaged at least four times. The default value is 0.
X Display Range	A 32-bit float that is the X-axis duration of the waveform that is displayed. For time domain waveforms, it is the duration of time across the display. If the value is zero then no data has been acquired.
X Display Origin	A 64-bit double that is the X-axis value at the left edge of the display. For time domain waveforms, it is the time at the start of the display. This value is treated as a double precision 64-bit floating point number. If the value is zero then no data has been acquired.
X Increment	A 64-bit double that is the duration between data points on the X axis. For time domain waveforms, this is the time between points. If the value is zero then no data has been acquired.
X Origin	A 64-bit double that is the X-axis value of the first data point in the data record. For time domain waveforms, it is the time of the first point. This value is treated as a double precision 64-bit floating point number. If the value is zero then no data has been acquired.
X Units	A 32-bit integer that identifies the unit of measure for X values in the acquired data: <ul style="list-style-type: none"> • 0 = Unknown. • 1 = Volts. • 2 = Seconds. • 3 = Constant. • 4 = Amps. • 5 = dB. • 6 = Hz.
Y Units	A 32-bit integer that identifies the unit of measure for Y values in the acquired data. The possible values are listed above under X Units.
Date	A 16-byte character array, left blank in InfiniiVision oscilloscopes.
Time	A 16-byte character array, left blank in the InfiniiVision oscilloscopes.

Frame	A 24 byte character array that is the model number and serial number of the oscilloscope in the format of: MODEL#:SERIAL#.
Waveform Label	A 16 byte character array that contains the label assigned to the waveform.
Time Tags	A 64-bit double, only used when saving multiple segments (requires segmented memory option). This is the time (in seconds) since the first trigger.
Segment Index	A 32-bit unsigned integer. This is the segment number. Only used when saving multiple segments.

Waveform Data Header

A waveform may have more than one data set. Each waveform data set will have a waveform data header. The waveform data header consists of information about the waveform data set. This header is stored immediately before the data set.

Waveform Data Header Size	A 32-bit integer that is the size of the waveform data header.
Buffer Type	A 16-bit short that is the type of waveform data stored in the file: <ul style="list-style-type: none"> • 0 = Unknown data. • 1 = Normal 32-bit float data. • 2 = Maximum float data. • 3 = Minimum float data. • 4 = Not used in InfiniiVision oscilloscopes. • 5 = Not used in InfiniiVision oscilloscopes. • 6 = Digital unsigned 8-bit char data (for digital channels).
Bytes Per Point	A 16-bit short that is the number of bytes per data point.
Buffer Size	A 32-bit integer that is the size of the buffer required to hold the data points.

Example Program for Reading Binary Data

To find an example program for reading binary data, direct your web browser to "www.agilent.com/find/3000X-Series-examples", and select "Example Program for Reading Binary Data".

Examples of Binary Files

**Single Acquisition
Multiple Analog Channels**

The following picture shows a binary file of a single acquisition with multiple analog channels.

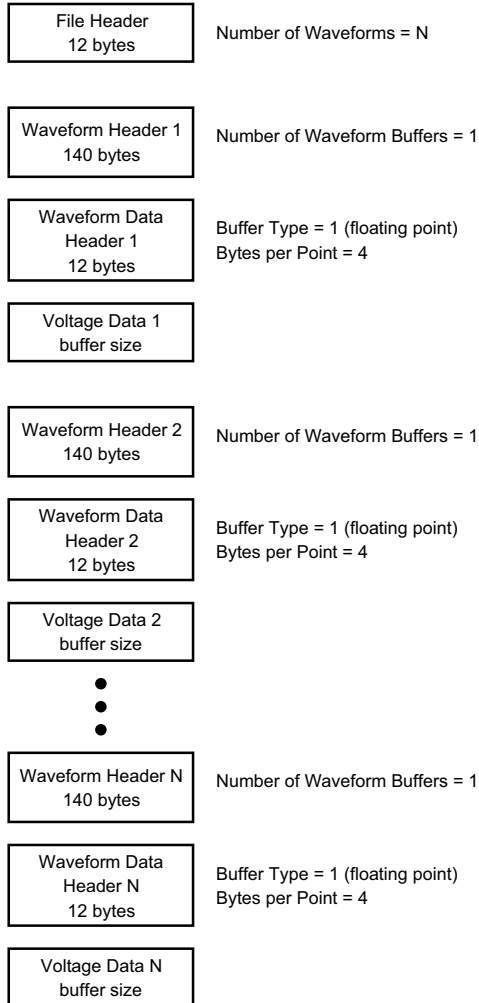

Single Acquisition All Pods Logic Channels

The following picture shows a binary file of a single acquisition with all pods for the logic channels saved.

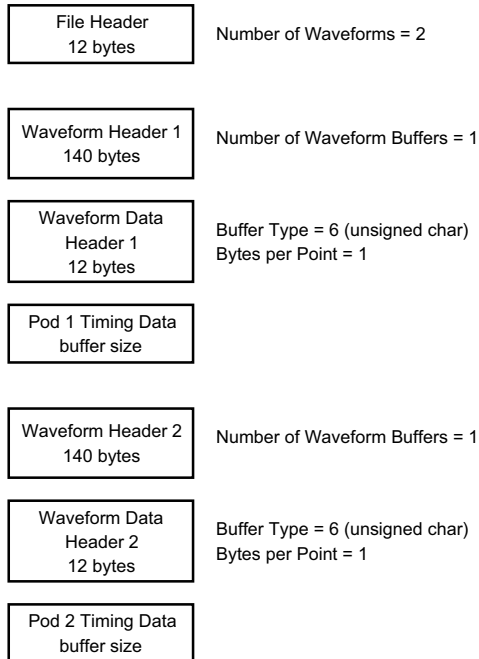

Segmented Memory Acquisition on One Analog Channel

The following picture shows a binary file of a segmented memory acquisition on one analog channel.

22 Reference

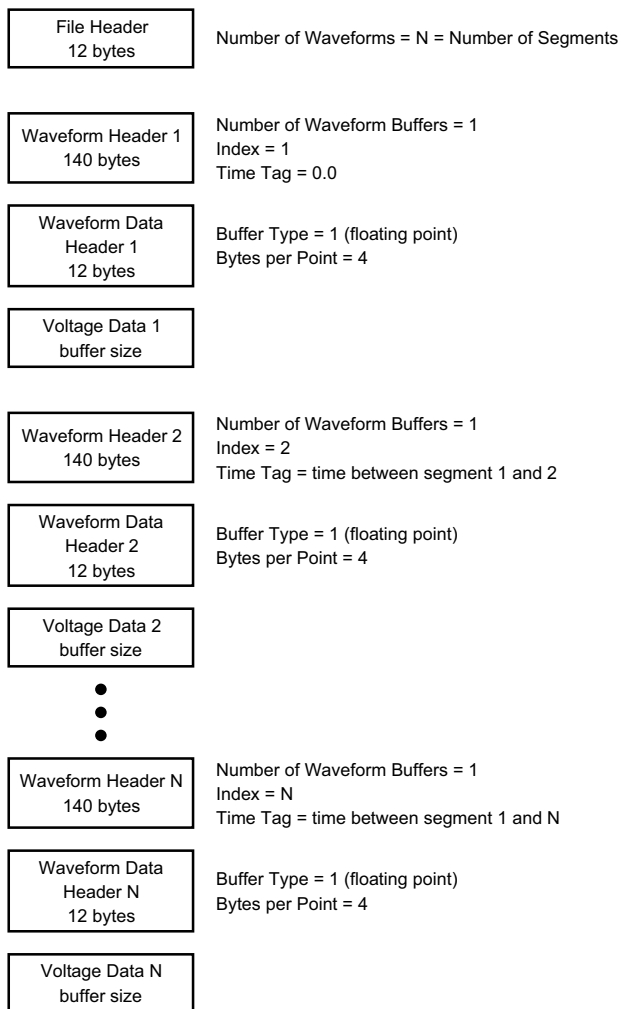

CSV and ASCII XY files

- ["CSV and ASCII XY file structure"](#) on page 349
- ["Minimum and Maximum Values in CSV Files"](#) on page 349

CSV and ASCII XY file structure

In CSV or ASCII XY format the **Length** control selects the number of points per segment. All segments are contained in the CSV file or in each ASCII XY data file.

For example: If the Length control is set to 1000 points, there will be 1000 points (rows in the spreadsheet) per segment. When saving all segments there are three header rows, so the data for the first segment starts at row 4. The second segment's data starts at row 1004. The time column shows the time since the trigger on the first segment. The top row shows the selected number of points per segment.

BIN files are a more efficient data transfer format than CSV or ASCII XY. Use this file format for fastest data transfer.

Minimum and Maximum Values in CSV Files

If you are running a Minimum or Maximum measurement, the minimum and maximum values shown in the measurement display may not appear in the CSV file.

Explanation: When the oscilloscope's sample rate is 4 GSa/s, a sample will be taken every 250 ps. If the horizontal scale is set to 10 us/div, there will be 100 us of data displayed (because there are ten divisions across the screen). To find the total number of samples the oscilloscope will take:

$$100 \text{ us} \times 4 \text{ GSa/s} = 400\text{K samples}$$

The oscilloscope is required to display those 400K samples using 640 pixel columns. The oscilloscope will decimate the 400K samples to 640 pixel columns, and this decimation keeps track of the min and max values of all the points that are represented by any given column. Those min and max values will be displayed in that screen column.

A similar process is used to reduce the acquired data to produce a record usable for various analysis needs such as measurements and CSV data. This analysis record (or *measurement record*) is much larger than 640 and may in fact contain up to 65536 points. Still, once the # of acquired points > 65536, some form of decimation is required. The decimator used to produce a CSV record is configured to provide a best-estimate of all the samples that each point in the record represents. Therefore, the min and max values may not appear in the CSV file.

Acknowledgements

RealVNC RealVNC is licensed under the GNU General Public License. Copyright (C) 2002-2005 RealVNC Ltd. All Rights Reserved.

This is free software; you can redistribute it and/or modify it under the terms of the GNU General Public License as published by the Free Software Foundation; either version 2 of the License, or (at your option) any later version.

This software is distributed in the hope that it will be useful, but WITHOUT ANY WARRANTY; without even the implied warranty of MERCHANTABILITY or FITNESS FOR A PARTICULAR PURPOSE. See the GNU General Public License for more details.

This license is located on the Agilent InfiniiVision Oscilloscopes Documentation CD-ROM.

RealVNC source code can be obtained from RealVNC or by contacting Agilent. Agilent will charge for the cost of physically performing the source distribution.

HDF5 Reference Waveform files use HDF5.

HDF5 was developed by "The HDF Group" and by the National Center for Supercomputing Applications at the University of Illinois at Urbana-Champaign.

CUPS Network printing uses the CUPS (Common Unix Printing System) library.

The CUPS and CUPS Imaging libraries are developed by Apple Inc. and licensed under the GNU Library General Public License ("LGPL"), Version 2.

This license is located on the Agilent InfiniiVision Oscilloscopes Documentation CD-ROM.

mDNSResponder CUPS network printing uses the mDNSResponder library.

The mDNSResponder library is developed by Apple Inc. and licensed under the Apache License, Version 2.0.

This license is located on the Agilent InfiniiVision Oscilloscopes Documentation CD-ROM.

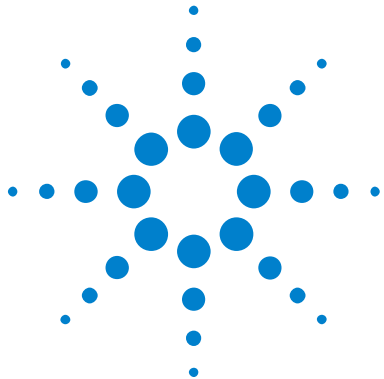

23 CAN/LIN Triggering and Serial Decode

Setup for CAN Signals	351
CAN Triggering	353
CAN Serial Decode	355
Setup for LIN Signals	359
LIN Triggering	361
LIN Serial Decode	363

CAN/LIN triggering and serial decode requires Option AUTO or the DSOX3AUTO upgrade.

Setup for CAN Signals

Setup consists of connecting the oscilloscope to a CAN signal, using the Signals Menu to specify the signal source, threshold voltage level, baud rate, and sample point.

To set up the oscilloscope to capture CAN signals, use the **Signals** softkey which appears in the Serial Decode Menu:

- 1 Press [**Label**] to turn on labels.
- 2 Press [**Serial**].
- 3 Press the **Serial** softkey, turn the Entry knob to select the desired slot (Serial 1 or Serial 2), and press the softkey again to enable decode.
- 4 Press the **Mode** softkey; then, select **CAN** trigger type.
- 5 Press the **Signals** softkey to open the CAN Signals Menu.



23 CAN/LIN Triggering and Serial Decode



- 6 Press **Source**; then, select the channel for the CAN signal.

The label for the CAN source channel is automatically set.

- 7 Press the **Threshold** softkey; then, turn the Entry knob to select the CAN signal threshold voltage level.

The threshold voltage level is used in decoding, and it will become the trigger level when the trigger type is set to the selected serial decode slot.

- 8 Press the **Baud** softkey; then, turn the Entry knob to select the baud rate that matches match your CAN bus signal.

The CAN baud rate can be set to predefined baud rates from 10 kb/s up to 5 Mb/s or a user-defined baud rate from 10.0 kb/s to 4 Mb/s in increments of 100 b/s. Fractional user-defined baud rates between 4 Mb/s and 5 Mb/s are not allowed.

The default baud rate is 125 kb/s

If none of the pre-defined selections match your CAN bus signal, select **User Defined**; then, press the **User Baud** softkey and turn the Entry knob to enter the baud rate.

- 9 Press the **Sample Point** softkey; then, turn the Entry knob to select the point between phase segments 1 and 2 where the state of the bus is measured. This controls the point within the bit's time where the bit value is captured.

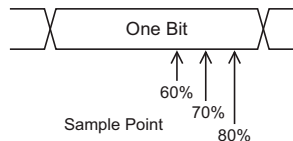

- 10 Press the **Signal** softkey and select the type and polarity of the CAN signal. This also automatically sets the channel label for the source channel.

- **CAN_H** – The actual CAN_H differential bus.

- **Differential (H-L)** – The CAN differential bus signals connected to an analog source channel using a differential probe. Connect the probe's positive lead to the dominant-high CAN signal (CAN_H) and connect the negative lead to the dominant-low CAN signal (CAN_L).

Dominant low signals:

- **Rx** – The Receive signal from the CAN bus transceiver.
- **Tx** – The Transmit signal from the CAN bus transceiver.
- **CAN_L** – The actual CAN_L differential bus signal.
- **Differential (L-H)** – The CAN differential bus signals connected to an analog source channel using a differential probe. Connect the probe's positive lead to the dominant-low CAN signal (CAN_L) and connect the negative lead to the dominant-high CAN signal (CAN_H).

CAN Triggering

To set up the oscilloscope to capture a CAN signal, see "[Setup for CAN Signals](#)" on page 351.

The Controller Area Network (CAN) trigger allows triggering on CAN version 2.0A and 2.0B signals.

A CAN message frame in CAN_L signal type is shown below:



After setting up the oscilloscope to capture a CAN signal:

- 1 Press [**Trigger**].
- 2 In the Trigger Menu, press the **Trigger** softkey; then, turn the Entry knob to select the serial slot (Serial 1 or Serial 2) on which the CAN signal is being decoded.



- 3 Press the **Trigger:** softkey; then, turn the Entry knob to select the trigger condition:
 - **SOF - Start of Frame** – The oscilloscope triggers at the start of a frame.
 - **Remote Frame ID (RTR)** – The oscilloscope triggers on remote frames with the specified ID. Press the **Bits** softkey to select the ID.
 - **Data Frame ID (~RTR)** – The oscilloscope will trigger on data frames matching the specified ID. Press the **Bits** softkey to select the ID.
 - **Remote or Data Frame ID** – The oscilloscope will trigger on remote or data frames matching the specified ID. Press the **Bits** softkey to select the ID.
 - **Data Frame ID and Data** – The oscilloscope will trigger on data frames matching the specified ID and data. Press the **Bits** softkey to select the ID and set up the number of data bytes and values.
 - **Error Frame** – The oscilloscope will trigger on CAN active error frames.
 - **All Errors** – The oscilloscope will trigger when any form error or active error is encountered.
 - **Acknowledge Error** – The oscilloscope will trigger when the acknowledge bit is recessive (high).
 - **Overload Frame** – The oscilloscope will trigger on CAN overload frames.
- 4 If you select a condition that lets you trigger on ID or data values, use the **Bits** softkey and the CAN Bits Menu to specify those values.

For details about using the CAN Bits Menu softkeys, press and hold the softkey in question to display the built-in help.

You can use the **Zoom** mode for easier navigation of the decoded data.

NOTE

If the setup does not produce a stable trigger, the CAN signal may be slow enough that the oscilloscope is AutoTriggering. Press the [**Mode/Coupling**] key, then press the **Mode** softkey to set the trigger mode from **Auto** to **Normal**.

NOTE

To display CAN serial decode, see ["CAN Serial Decode"](#) on page 355.

CAN Serial Decode

To set up the oscilloscope to capture CAN signals, see ["Setup for CAN Signals"](#) on page 351.

NOTE

For CAN triggering set up see ["CAN Triggering"](#) on page 353.

To set up CAN serial decode:

- 1 Press **[Serial]** to display the Serial Decode Menu.



- 2 If the decode line does not appear on the display, press the **[Serial]** key to turn it on.
- 3 If the oscilloscope is stopped, press the **[Run/Stop]** key to acquire and decode data.

NOTE

If the setup does not produce a stable trigger, the CAN signal may be slow enough that the oscilloscope is AutoTriggering. Press the **[Mode/Coupling]** key, then press the **Mode** softkey to set the trigger mode from **Auto** to **Normal**.

You can use the horizontal **Zoom** window for easier navigation of the decoded data.

- See Also**
- ["Interpreting CAN Decode"](#) on page 356
 - ["CAN Totalizer"](#) on page 357
 - ["Interpreting CAN Lister Data"](#) on page 358
 - ["Searching for CAN Data in the Lister"](#) on page 359

Interpreting CAN Decode

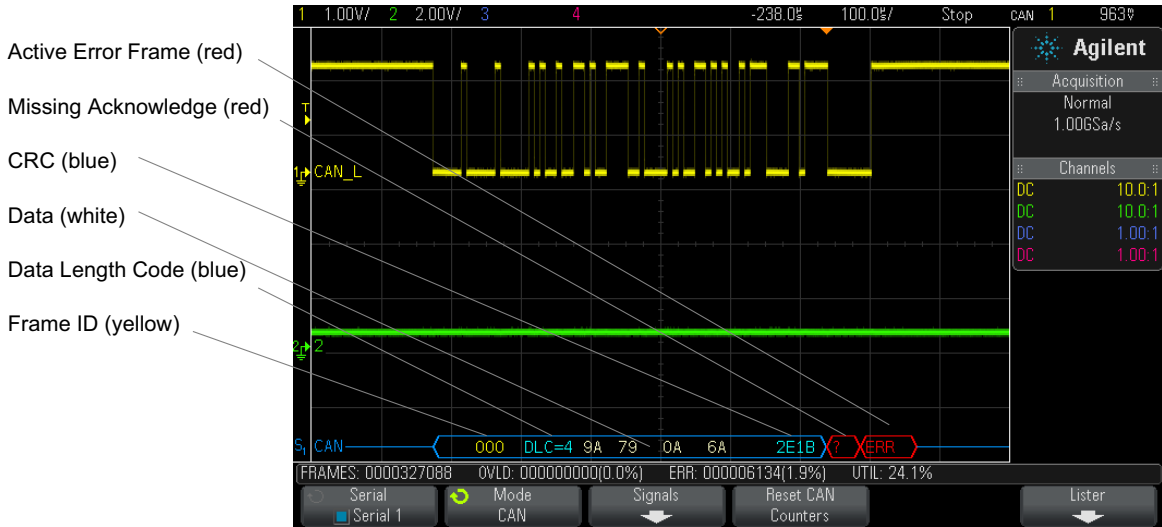

- Frame ID appears in hex digits in yellow. Frames of 11 or 29 bits are automatically detected.
- Remote frame (RMT) appears in green.
- Data length code (DLC) appears in blue for data frames and green for remote frames.
- Data bytes appear in hex digits in white for data frames.
- Cyclic redundancy check (CRC) appears in hex digits in blue when valid, or in red to indicate that the oscilloscope's hardware decode calculated a CRC that is different from the incoming CRC data stream.
- Angled waveforms show an active bus (inside a packet/frame).
- Mid-level blue lines show an idle bus.
- Decoded text is truncated at the end of the associated frame when there is insufficient space within frame boundaries.
- Pink vertical bars indicate you need to expand the horizontal scale (and run again) to see decode.
- Red dots in the decode line indicate that there is data that is not being displayed. Scroll or expand the horizontal scale to view the information.

- Aliased bus values (undersampled or indeterminate) are drawn in pink.
- Unknown bus values (undefined or error conditions) are drawn in red with a "?" label.
- Flagged error frames are drawn in red with an "ERR" label.

CAN Totalizer

The CAN totalizer provides a direct measure of bus quality and efficiency. The CAN totalizer measures total CAN frames, flagged error frames, overload frames, and bus utilization.

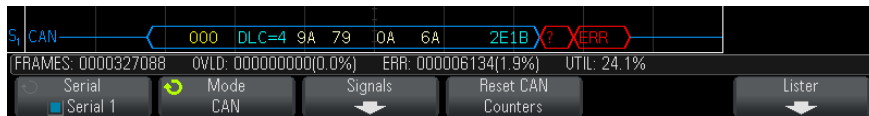

The totalizer is always running (counting frames and calculating percentages) and is displayed whenever CAN decode is displayed. The totalizer counts even when the oscilloscope is stopped (not acquiring data). Pressing the **[Run/Stop]** key does not affect the totalizer. When an overflow condition occurs, the counter displays **OVERFLOW**. The counters can be reset to zero by pressing the **Reset CAN Counters** softkey.

Types of Frames

- Active error frames are CAN frames in which a CAN node recognizes an error condition during a data or remote frame and issues an active error flag.
- A partial frame occurs when the oscilloscope detects any error condition during a frame that is not followed by an active error flag. Partial frames are not counted.

Counters

- The FRAMES counter gives the total number of completed remote, data, overload, and active error frames.
- The OVLD counter gives the total number of completed overload frames and their percentage of the total number of frames.
- The ERR counter gives the total number of completed active error frames and their percentage of the total number of frames.
- The UTIL (bus load) indicator measures the percentage of time the bus is active. The calculation is done on 330 ms periods, approximately every 400 ms.

23 CAN/LIN Triggering and Serial Decode

Example: If a data frame contains an active error flag, both the FRAMES counter and the ERR counter will be incremented. If a data frame contains an error that is not an active error it is considered a partial frame and no counters are incremented.

Interpreting CAN Lister Data

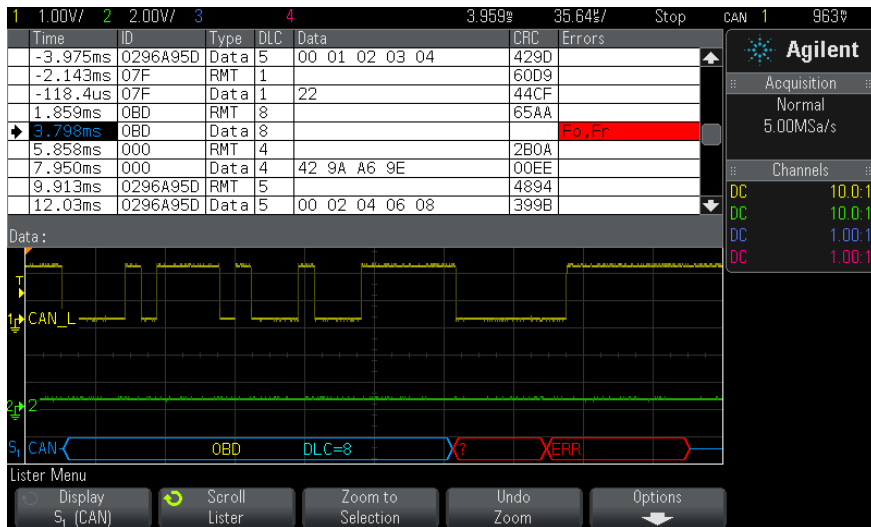

In addition to the standard Time column, the CAN Lister contains these columns:

- ID – frame ID.
- Type – frame type (RMT remote frame or Data).
- DLC – data length code.
- Data – data bytes.
- CRC – cyclic redundancy check.
- Errors – highlighted in red. Errors can be Acknowledge (Ack, A), Form (Fo), or Frame (Fr). Different kinds of errors can be combined like "Fo,Fr" in the above example.

Aliased data is highlighted in pink. When this happens, decrease the horizontal time/div setting and run again.

Searching for CAN Data in the Lister

The oscilloscope's search capability lets you search for (and mark) certain types of CAN data in the Lister. You can use the **[Navigate]** key and controls to navigate through the marked rows.

- 1 With CAN selected as the serial decode mode, press **[Search]**.
- 2 In the Search Menu, press the **Search** softkey; then, turn the Entry knob to select the serial slot (Serial 1 or Serial 2) on which the CAN signal is being decoded.
- 3 Press **Search**; then, select from these options:
 - **Remote Frame ID (RTR)** – Finds remote frames with the specified ID. Press the Bits softkey to enter the ID.
 - **Data Frame ID (~RTR)** – Finds data frames matching the specified ID. Press the Bits softkey to enter the ID.
 - **Remote or Data Frame ID** – Finds remote or data frames matching the specified ID. Press the Bits softkey to select the ID.
 - **Data Frame ID and Data** – Finds data frames matching the specified ID and data. Press the Bits softkey to set the ID length, ID value, number of data bytes, and data value.
 - **Error Frame** – Finds CAN active error frames.
 - **All Errors** – Finds any form error or active error.
 - **Overload Frame** – Finds CAN overload frames.

For more information on searching data, see ["Searching Lister Data"](#) on page 128.

For more information on using the **[Navigate]** key and controls, see ["Navigating the Time Base"](#) on page 60.

Setup for LIN Signals

LIN (Local Interconnect Network) signal setup consists of connecting the oscilloscope to a serial LIN signal, specifying the signal source, threshold voltage level, baud rate, sample point, and other LIN signal parameters.

To set up the oscilloscope to capture LIN signals:

- 1 Press **[Label]** to turn on labels.

23 CAN/LIN Triggering and Serial Decode

- 2 Press [**Serial**].
- 3 Press the **Serial** softkey, turn the Entry knob to select the desired slot (Serial 1 or Serial 2), and press the softkey again to enable decode.
- 4 Press the **Mode** softkey; then, select **LIN** trigger type.
- 5 Press the **Signals** softkey to open the LIN Signals Menu.



- 6 Press the **Source** softkey to select the channel connected to the LIN signal line.

The label for the LIN source channel is automatically set.

- 7 Press the **Threshold** softkey; then, turn the Entry knob to set the LIN signal threshold voltage level to the middle of the LIN signal.

The threshold voltage level is used in decoding, and it will become the trigger level when the trigger type is set to the selected serial decode slot.

- 8 Press the **Baud Rate** softkey to open the LIN Baud Rate Menu.
- 9 Press the **Baud** softkey; then, turn the Entry knob to select the baud rate that matches your LIN bus signal.

The default baud rate is 19.2 kb/s.

If none of the pre-defined selections match your LIN bus signal, select **User Defined**; then, press the **User Baud** softkey and turn the Entry knob to enter the baud rate.

You can set the LIN baud rate from 2.4 kb/s to 625 kb/s in increments of 100 b/s.

- 10 Press the  Back/Up key to return to the LIN Signals Menu.
- 11 Press the **Sample Point** softkey; then, turn the Entry knob to select the sample point at which the oscilloscope will sample the bit value.

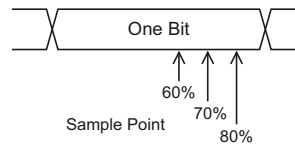

- 12** Press the **Standard** softkey; then, turn the Entry knob to select the LIN standard you are measuring (LIN 1.3 or LIN 2.0).

For LIN 1.2 signals, use the LIN 1.3 setting. The LIN 1.3 setting assumes the signal follows the "Table of Valid ID Values" as shown in section A.2 of the LIN Specification dated December 12, 2002. If your signal does not comply with the table, use the LIN 2.0 setting.

- 13** Press the **Sync Break** softkey and select the minimum number of clocks that define a sync break in your LIN signal.

LIN Triggering

To set up the oscilloscope to capture a LIN signal, see "[Setup for LIN Signals](#)" on page 359.

LIN triggering can trigger on the rising edge at the Sync Break exit of the LIN single-wire bus signal (that marks the beginning of the message frame), the Frame ID, or the Frame ID and Data.

A LIN signal message frame is shown below:

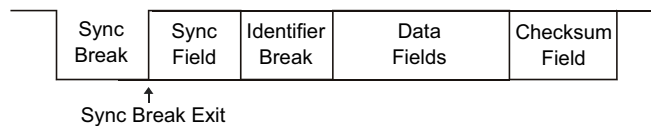

- 1** Press [**Trigger**].
- 2** In the Trigger Menu, press the **Trigger** softkey; then, turn the Entry knob to select the serial slot (Serial 1 or Serial 2) on which the CAN signal is being decoded.

23 CAN/LIN Triggering and Serial Decode



3 Press the **Trigger:** softkey; then, turn the Entry knob to select the trigger condition:

- **Sync** (Sync Break) – The oscilloscope triggers on the rising edge at the Sync Break exit of the LIN single-wire bus signal that marks the beginning the message frame.
- **ID** (Frame ID) – The oscilloscope triggers when a frame with an ID equal to the selected value is detected. Use the **Entry** knob to select the value for the Frame ID.
- **ID & Data** (Frame ID and Data) – The oscilloscope triggers when a frame with an ID and data equal to the selected values is detected. When triggering on a frame ID and data:
 - To select the frame ID value, press the **Frame ID** softkey, and use the **Entry** knob.

Note that you can enter a "don't care" value for the frame ID and trigger on data values only.

- To set up the number of data bytes and enter their values (in hexadecimal or binary), press the **Bits** softkey to open the LIN Bits Menu.



NOTE

For details about using the LIN Bits Menu softkeys, press and hold the softkey in question to display the built-in help.

NOTE

For LIN decode information see "[LIN Serial Decode](#)" on page 363.

LIN Serial Decode

To set up the oscilloscope to capture LIN signals, see ["Setup for LIN Signals"](#) on page 359.

NOTE

For LIN triggering setup see ["LIN Triggering"](#) on page 361.

To set up LIN serial decode:

- 1 Press **[Serial]** to display the Serial Decode Menu.



- 2 Choose whether to include the parity bits in the identifier field.
 - a If you want to mask the upper two parity bits, ensure that the box under the **Show Parity** softkey is not selected.
 - b If you want to include the parity bits in the identifier field, ensure that the box under the **Show Parity** softkey is selected.
- 3 If the decode line does not appear on the display, press the **[Serial]** key to turn it on.
- 4 If the oscilloscope is stopped, press the **[Run/Stop]** key to acquire and decode data.

NOTE

If the setup does not produce a stable trigger, the LIN signal may be slow enough that the oscilloscope is AutoTriggering. Press the **[Mode/Coupling]** key, then press the **Mode** softkey to set the trigger mode from **Auto** to **Normal**.

You can use the horizontal **Zoom** window for easier navigation of the decoded data.

- See Also**
- ["Interpreting LIN Decode"](#) on page 364
 - ["Interpreting LIN Lister Data"](#) on page 365
 - ["Searching for LIN Data in the Lister"](#) on page 366

Interpreting LIN Decode

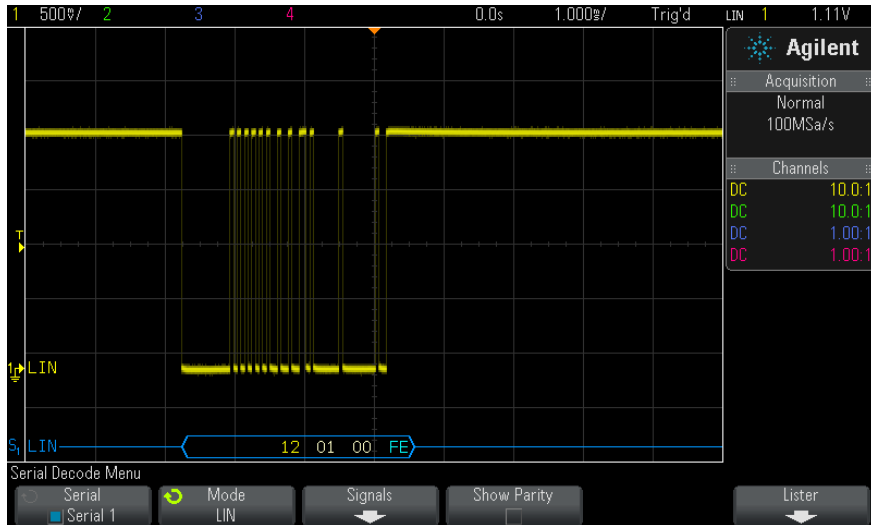

- Angled waveforms show an active bus (inside a packet/frame).
- Mid-level blue lines show an idle bus (LIN 1.3 only).
- The hexadecimal ID and parity bits (if enabled) appear in yellow. If a parity error is detected the hexadecimal ID and parity bits (if enabled) appear in red.
- Decoded hexadecimal data values appear in white.
- For LIN 1.3, the checksum appears in blue if correct, or red if incorrect. The checksum always appears in white for LIN 2.0.
- Decoded text is truncated at the end of the associated frame when there is insufficient space within frame boundaries.
- Pink vertical bars indicate you need to expand the horizontal scale (and run again) to see decode.
- Red dots in the decode line indicate that there is data that is not being displayed. Scroll or expand the horizontal scale to view the information.
- Unknown bus values (undefined or error conditions) are drawn in red.
- If there is an error in the synch field, SYNC will appear in red.

- If the header exceeds the length specified in the standard, THM will appear red.
- If the total frame count exceeds the length specified in the standard, TFM will appear red (LIN 1.3 only).
- For LIN 1.3 a wakeup signal is indicated by WAKE in blue. If the wakeup signal is not followed by a valid wakeup delimiter a wakeup error is detected and displayed as WUP in red.

Interpreting LIN Lister Data

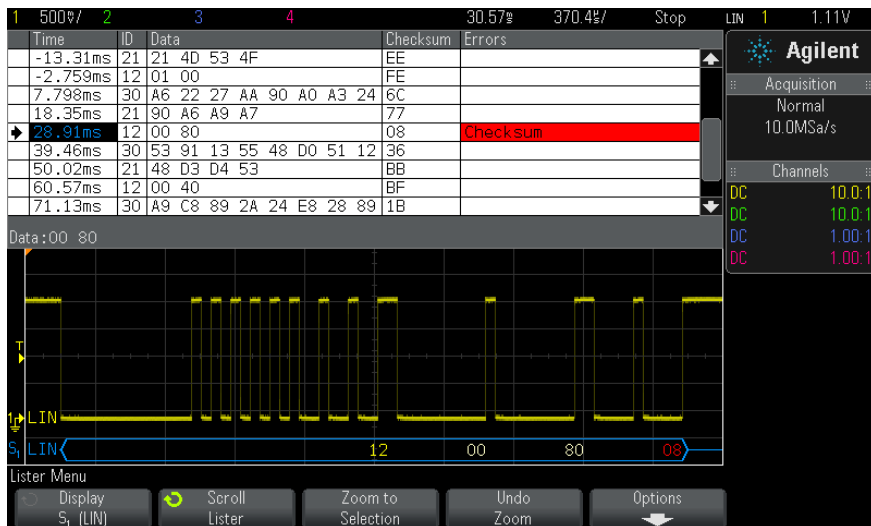

In addition to the standard Time column, the LIN Lister contains these columns:

- ID – frame ID.
- Data – (LIN 1.3 only) data bytes.
- Checksum – (LIN 1.3 only).
- Data and Checksum – (LIN 2.0 only).
- Errors – highlighted in red.

Aliased data is highlighted in pink. When this happens, decrease the horizontal time/div setting and run again.

Searching for LIN Data in the Lister

The oscilloscope's search capability lets you search for (and mark) certain types of LIN data in the Lister. You can use the **[Navigate]** key and controls to navigate through the marked rows.

- 1 With LIN selected as the serial decode mode, press **[Search]**.
- 2 In the Search Menu, press the **Search** softkey; then, turn the Entry knob to select the serial slot (Serial 1 or Serial 2) on which the LIN signal is being decoded.
- 3 Press **Search**; then, select from these options:
 - **ID** – Finds frames with the specified ID. Press the Frame ID softkey to select the ID.
 - **ID & Data** – Finds frames with the specified ID and data. Press the Frame ID softkey to select the ID. Press the Bits softkey to enter the data value.
 - **Errors** – Finds all errors.

For more information on searching data, see "[Searching Lister Data](#)" on page 128.

For more information on using the **[Navigate]** key and controls, see "[Navigating the Time Base](#)" on page 60.

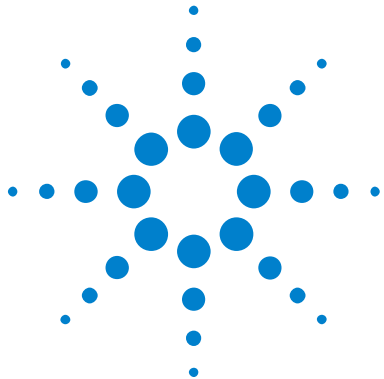

24 FlexRay Triggering and Serial Decode

Setup for FlexRay Signals 367

FlexRay Triggering 368

FlexRay Serial Decode 371

FlexRay triggering and serial decode requires Option FLEX or the DSOX3FLEX upgrade.

Setup for FlexRay Signals

FlexRay signal setup consists of first connecting the oscilloscope to a differential FlexRay signal using a differential active probe (the Agilent N2792A is recommended), specifying the signal source, threshold voltage trigger level, baud rate, and bus type.

To set up the oscilloscope to capture FlexRay signals:

- 1 Press **[Label]** to turn on labels.
- 2 Press **[Serial]**.
- 3 Press the **Serial** softkey, turn the Entry knob to select the desired serial bus (Serial 1 or Serial 2), and press the softkey again to enable decode.
- 4 Press the **Mode** softkey; then, select **FlexRay** mode.
- 5 Press the **Signals** softkey to open the FlexRay Signals Menu.



24 FlexRay Triggering and Serial Decode

- 6 Press **Source** and select the analog channel that is probing the FlexRay signal.
- 7 Press **Threshold**; then, turn the Entry knob to set the threshold voltage level.

The threshold level should be set below the idle level.

The threshold voltage level is used in decoding and will become the trigger level when the trigger type is set to the selected serial decode bus.

- 8 Press **Baud** and select the baud rate of the FlexRay signal being probed.
- 9 Press **Bus** and select the bus type of the FlexRay signal being probed.

It is important to specify the correct bus because this setting affects CRC error detection.

- 10 Press **Auto Setup** to perform the following actions:

- Sets the selected source channel's impedance to 50 Ohms, assuming a differential active probe that requires a 50 ohm termination is being used .
- Sets the selected source channel's probe attenuation to 10:1.
- Sets the trigger level (on the selected source channel) to -300 mV.
- Turns on trigger Noise Reject.
- Turns on Serial Decode.
- Sets the trigger type to FlexRay.

FlexRay Triggering

To set up the oscilloscope to capture a FlexRay signal, see "[Setup for FlexRay Signals](#)" on page 367.

After you have set up the oscilloscope to capture a FlexRay signal, you can then set up triggers on frames (see [page 369](#)), errors (see [page 370](#)), or events (see [page 370](#)).

NOTE

To display FlexRay serial decode, see "[FlexRay Serial Decode](#)" on page 371.

Triggering on FlexRay Frames

- 1 Press [**Trigger**].
- 2 In the Trigger Menu, press the **Trigger** softkey; then, turn the Entry knob to select the serial bus (Serial 1 or Serial 2) on which the FlexRay signals are being decoded.



- 3 Press the **Trigger** softkey; then, turn the Entry knob to select **Frame**.
- 4 Press the **Frames** softkey to open the FlexRay Frame Trigger Menu.



- 5 Press the **Frame ID** softkey, and use the Entry knob to select the frame ID value from **All** or 1 to 2047.
- 6 Press the **Frame Type** softkey to select the frame type:
 - **All Frames**
 - **Startup Frames**
 - **NULL Frames**
 - **Sync Frames**
 - **Normal Frames**
 - **NOT Startup Frames**
 - **NOT NULL Frames**
 - **NOT Sync Frames**
- 7 Press the **Cyc Ct Rep** softkey, and use the Entry knob to select the cycle count repetition factor (**2, 4, 8, 16, 32, or 64, or All**).
- 8 Press the **Cyc Ct Bas** softkey, and use the Entry knob to select the cycle count base factor from 0 through the **Cyc Ct Rep** factor minus 1.

For example, with a base factor of 1 and a repetition factor of 16, the oscilloscope triggers on cycles 1, 17, 33, 49, and 65.

24 FlexRay Triggering and Serial Decode

To trigger on a particular cycle, set the Cycle Repetition factor to 64 and use the cycle base factor to choose a cycle.

To trigger all (any) cycles, set the Cycle Repetition factor to All. The scope will trigger on any and all cycles.

NOTE

Because specific FlexRay frames may occur infrequently, it may be helpful to press the **[Mode/Coupling]** key, then press the **Mode** softkey to set the trigger mode from **Auto** to **Normal**. This prevents the oscilloscope from Auto triggering while waiting for a particular frame and cycle combination.

Triggering on FlexRay Errors

- 1 Press **[Trigger]**.
- 2 In the Trigger Menu, press the **Trigger** softkey; then, turn the Entry knob to select the serial bus (Serial 1 or Serial 2) on which the FlexRay signals are being decoded.
- 3 Press the **Trigger** softkey; then, turn the Entry knob to select **Error**.



- 4 Press the **Errors** softkey; then, select the error type:
 - **All Errors**
 - **Header CRC Error** – cyclic redundancy check error in the header.
 - **Frame CRC Error** – cyclic redundancy check error in the frame.

NOTE

Because FlexRay errors occur infrequently it may be helpful to set the oscilloscope to press the **[Mode/Coupling]** key, then press the **Mode** softkey to set the trigger mode from **Auto** to **Normal**. This prevents the oscilloscope from Auto triggering while waiting for an error to occur. You may need to adjust trigger holdoff to see a particular error when multiple errors exist.

Triggering on FlexRay Events

- 1 Press **[Trigger]**.

- 2 In the Trigger Menu, press the **Trigger** softkey; then, turn the Entry knob to select the serial bus (Serial 1 or Serial 2) on which the FlexRay signals are being decoded.
- 3 Press the **Trigger** softkey; then, turn the Entry knob to select **Event**.



- 4 Press the **Event** softkey; then, select the event type:
 - **Wake-up**
 - **TSS** – Transmission Start Sequence.
 - **BSS** – ByteStart Sequence.
 - **FES/DTS** – Frame End or Dynamic Trailing Sequence.
- 5 Press **Auto Setup for Event**.

This automatically configures oscilloscope settings (as shown on the display) for the selected event trigger.

FlexRay Serial Decode

To set up the oscilloscope to capture FlexRay signals, see "[Setup for FlexRay Signals](#)" on page 367.

NOTE

For FlexRay triggering setup see "[FlexRay Triggering](#)" on page 368.

To set up FlexRay serial decode:

- 1 Press [**Serial**] to display the Serial Decode Menu.



- 2 If the decode line does not appear on the display, press the [**Serial**] key to turn it on.

24 FlexRay Triggering and Serial Decode

- 3 If the oscilloscope is stopped, press the **[Run/Stop]** key to acquire and decode data.

You can use the horizontal **Zoom** window for easier navigation of the acquired data.

- See Also**
- ["Interpreting FlexRay Decode"](#) on page 372
 - ["FlexRay Totalizer"](#) on page 373
 - ["Interpreting FlexRay Lister Data"](#) on page 374
 - ["Searching for FlexRay Data in the Lister"](#) on page 374

Interpreting FlexRay Decode

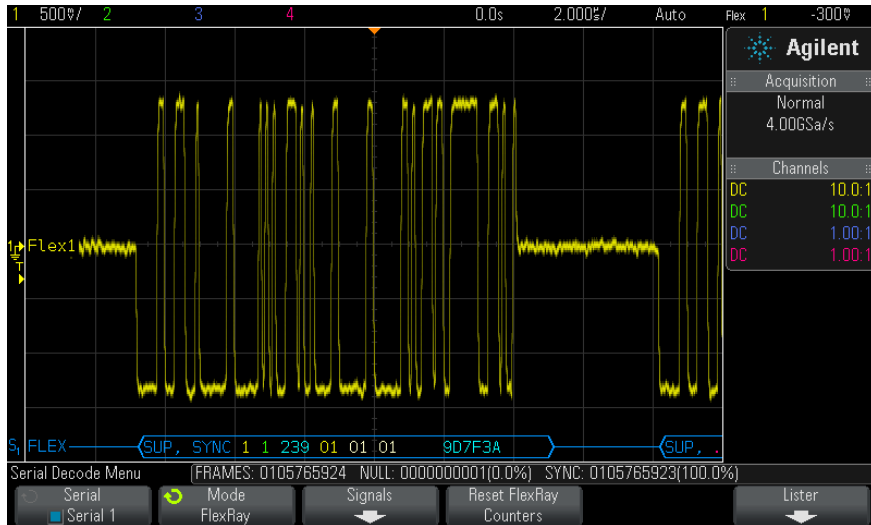

- Frame type (NORM, SYNC, SUP, NULL in blue).
- Frame ID (decimal digits in yellow).
- Payload-length (decimal number of words in green).
- Header CRC (hex digits in blue plus red HCRC error message if invalid).
- Cycle number (decimal digits in yellow).
- Data bytes (HEX digits in white).

- Frame CRC (hex digits in blue plus red FCRC error message if invalid).
- Frame/coding errors (specific error symbol in red).

FlexRay Totalizer

The FlexRay totalizer consists of counters that provide a direct measure of bus quality and efficiency. The totalizer appears on screen whenever FlexRay Decode is ON in the Serial Decode Menu.



- The **FRAMES** counter gives a real-time count of all captured frames.
- The **NULL** counter gives the number and percentage of null frames.
- The **SYNC** counter gives the number and percentage of sync frames.

The totalizer runs, counting frames and calculating percentages, even when the oscilloscope is stopped (not acquiring data).

When an overflow condition occurs, the counter displays **OVERFLOW**.

The counters can be reset to zero by pressing the **Reset FlexRay Counters** softkey.

Interpreting FlexRay Lister Data

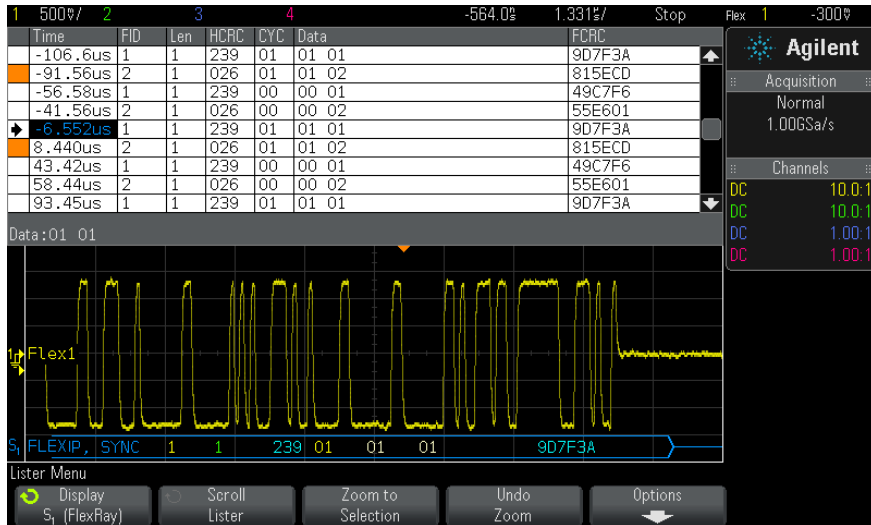

In addition to the standard Time column, the FlexRay Lister contains these columns:

- FID – frame ID.
- Len – payload length.
- HCRC – header CRC.
- CYC – cycle number.
- Data.
- FCRC – frame CRC.
- Frames with errors are highlighted in red.

Searching for FlexRay Data in the Lister

The oscilloscope's search capability lets you search for (and mark) certain types of FlexRay data in the Lister. You can use the **[Navigate]** key and controls to navigate through the marked rows.

- 1 With FlexRay selected as the serial decode mode, press **[Search]**.

- 2 In the Search Menu, press the **Search** softkey; then, turn the Entry knob to select the serial bus (Serial 1 or Serial 2) on which the FlexRay signals are being decoded.
- 3 In the Search Menu, press **Search for**; then, select from these options:
 - **Frame ID** – Finds frames with the specified ID. Press the Frame ID softkey to select the ID.
 - **Cycle number (+ Frame ID)** – Finds frames with the specified cycle number and ID. Press the Frame ID softkey to select the ID. Press the Cycle # softkey to select the number.
 - **Data (+ Frame ID + Cycle number)** – Finds frames with the specified data, cycle number, and frame ID. Press the **Frame ID** softkey to select the ID. Press the **Cycle #** softkey to select the number. Press the **Data** softkey to open a menu where you can enter the data value.
 - **Header CRC Error** – Finds cyclic redundancy check errors in headers.
 - **Frame CRC Error** – Finds cyclic redundancy check errors in frames.
 - **Errors** – finds all errors.

For more information on searching data, see "[Searching Lister Data](#)" on page 128.

For more information on using the **[Navigate]** key and controls, see "[Navigating the Time Base](#)" on page 60.

24 FlexRay Triggering and Serial Decode



25 I2C/SPI Triggering and Serial Decode

Setup for I2C Signals [377](#)

I2C Triggering [378](#)

I2C Serial Decode [382](#)

Setup for SPI Signals [386](#)

SPI Triggering [389](#)

SPI Serial Decode [391](#)

I2C/SPI triggering and serial decode requires Option EMBD or the DSOX3EMBD upgrade.

NOTE

Only one SPI serial bus can be decoded at a time.

Setup for I2C Signals

I²C (Inter-IC bus) signals setup consists of connecting the oscilloscope to the serial data (SDA) line and the serial clock (SCL) line and then specifying the input signal threshold voltage levels.

To set up the oscilloscope to capture I²C signals, use the **Signals** softkey which appears in the Serial Decode Menu:

- 1 Press [**Label**] to turn on labels.
- 2 Press [**Serial**].
- 3 Press the **Serial** softkey, turn the Entry knob to select the desired slot (Serial 1 or Serial 2), and press the softkey again to enable decode.



25 I2C/SPI Triggering and Serial Decode

- 4 Press the **Mode** softkey; then, select **I2C** trigger type.
- 5 Press the **Signals** softkey to open the I²C Signals Menu.



- 6 For both the SCL (serial clock) and SDA (serial data) signals:
 - a Connect an oscilloscope channel to the signal in the device under test.
 - b Press the **SCL** or **SDA** softkey; then, turn the Entry knob to select the channel for the signal.
 - c Press the corresponding **Threshold** softkey; then, turn the Entry knob to select the signal threshold voltage level.

The threshold voltage level is used in decoding, and it will become the trigger level when the trigger type is set to the selected serial decode slot.

Data must be stable during the whole high clock cycle or it will be interpreted as a start or stop condition (data transitioning while the clock is high).

The SCL and SDA labels for the source channels are automatically set.

I2C Triggering

To set up the oscilloscope to capture I2C signals, see "[Setup for I2C Signals](#)" on page 377.

After the oscilloscope has been set up to capture I2C signals, you can trigger on a stop/start condition, a restart, a missing acknowledge, an EEPROM data read, or on a read/write frame with a specific device address and data value.

- 1 Press [**Trigger**]; then, select the **I2C** trigger type.
- 2 Press [**Trigger**].

- 3 In the Trigger Menu, press the **Trigger** softkey; then, turn the Entry knob to select the serial slot (Serial 1 or Serial 2) on which the I²C signals are being decoded.



- 4 Press the **Trigger:** softkey; then, turn the Entry knob to select the trigger condition:
- **Start Condition**— The oscilloscope triggers when SDA data transitions from high to low while the SCL clock is high. For triggering purposes (including frame triggers), a restart is treated as a start condition.
 - **Stop Condition**— The oscilloscope triggers when data (SDA) transitions from low to high while the clock (SCL) is high.

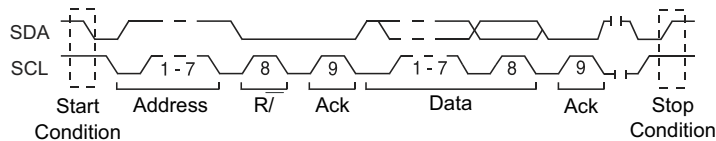

- **Missing Acknowledge**— The oscilloscope triggers when SDA data is high during any Ack SCL clock bit.
- **Address with no Ack**— The oscilloscope triggers when the acknowledge of the selected address field is false. The R/W bit is ignored.
- **Restart**— The oscilloscope triggers when another start condition occurs before a stop condition.
- **EEPROM Data Read**— The trigger looks for EEPROM control byte value 1010xxx on the SDA line, followed by a Read bit and an Ack bit. It then looks for the data value and qualifier set by the **Data** softkey and the **Data is** softkey. When this event occurs, the oscilloscope will trigger on the clock edge for the Ack bit after the data byte. This data byte does not need to occur directly after the control byte.

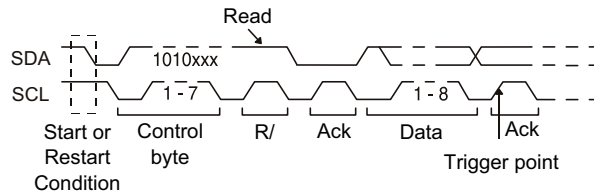

- **Frame (Start: Addr7: Read: Ack: Data) or Frame (Start: Addr7: Write: Ack: Data)**— The oscilloscope triggers on a read or write frame in 7-bit addressing mode on the 17th clock edge if all bits in the pattern match. For triggering purposes, a restart is treated as a start condition.

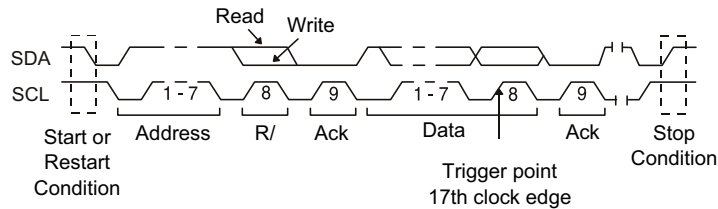

- **Frame (Start: Addr7: Read: Ack: Data: Ack: Data2) or Frame (Start: Addr7: Write: Ack: Data: Ack: Data2)**— The oscilloscope triggers on a read or write frame in 7-bit addressing mode on the 26th clock edge if all bits in the pattern match. For triggering purposes, a restart is treated as a start condition.

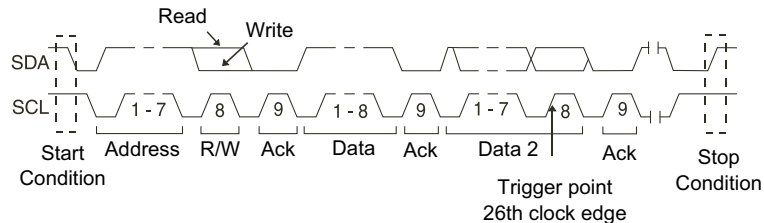

- **10-bit Write** – The oscilloscope triggers on a 10-bit write frame on the 26th clock edge if all bits in the pattern match. The frame is in the format:

Frame (Start: Address byte 1: Write: Address byte 2: Ack: Data)

For triggering purposes, a restart is treated as a start condition.

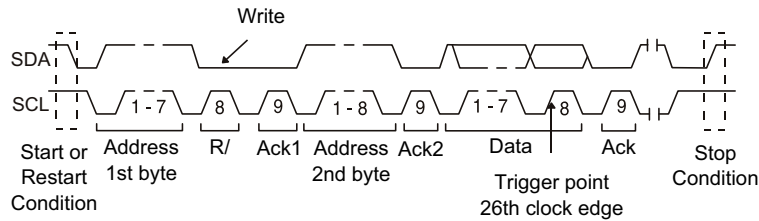

- 5 If you have set the oscilloscope to trigger on an EEPROM Data Read condition:

Press the **Data is** softkey to set the oscilloscope to trigger when data is = (equal to), ≠ (not equal to), < (less than), or > (greater than) the data value set in the **Data** softkey.

The oscilloscope will trigger on the clock edge for the Ack bit after the trigger event is found. This data byte does not need to occur directly after the control byte. The oscilloscope will trigger on any data byte that meets the criteria defined by the **Data is** and **Data** softkeys during a current address read or a random read or a sequential read cycle.

- 6 If you have set the oscilloscope to trigger on a 7-bit address read or write frame condition or a 10-bit write frame condition:
- a Press the **Address** softkey and turn the Entry knob to select the 7-bit or 10-bit device address.

You can select from an address range of 0x00 to 0x7F (7-bit) or 0x3FF (10-bit) hexadecimal. When triggering on a read/write frame, the oscilloscope will trigger after the start, address, read/write, acknowledge, and data events occur.

If don't care is selected (0xXX or 0XXXX) for the address, the address will be ignored. The trigger will always occur on the 17th clock for 7-bit addressing or 26th clock for 10-bit addressing.

- b Press the **Data** value softkey and turn the Entry knob to select the 8-bit data pattern on which to trigger.

You can select a data value in the range of 0x00 to 0xFF (hexadecimal). The oscilloscope will trigger after the start, address, read/write, acknowledge, and data events occur.

25 I2C/SPI Triggering and Serial Decode

If don't care (0xXX) is selected for data, the data will be ignored. The trigger will always occur on the 17th clock for 7-bit addressing or 26th clock for 10-bit addressing.

- c If you have selected a three-byte trigger, press the **Data2** value softkey and turn the Entry knob to select the 8-bit data pattern on which to trigger.

NOTE

To display I2C serial decode, see "[I2C Serial Decode](#)" on page 382.

I2C Serial Decode

To set up the oscilloscope to capture I2C signals, see "[Setup for I2C Signals](#)" on page 377.

NOTE

For I2C triggering setup see "[I2C Triggering](#)" on page 378.

To set up I2C serial decode:

- 1 Press [**Serial**] to display the Serial Decode Menu.



- 2 Choose 7-bit or 8-bit address size. Use 8-bit address size to include the R/W bit as part of the address value, or choose 7-bit address size to exclude the R/W bit from the address value.
- 3 If the decode line does not appear on the display, press the [**Serial**] key to turn it on.
- 4 If the oscilloscope is stopped, press the [**Run/Stop**] key to acquire and decode data.

NOTE

If the setup does not produce a stable trigger, the I2C signals may be slow enough that the oscilloscope is AutoTriggering. Press the **[Mode/Coupling]** key, then press the **Mode** softkey to set the trigger mode from **Auto** to **Normal**.

You can use the horizontal **Zoom** window for easier navigation of the acquired data.

- See Also**
- "Interpreting I2C Decode" on page 383
 - "Interpreting I2C Lister Data" on page 384
 - "Searching for I2C Data in the Lister" on page 385

Interpreting I2C Decode

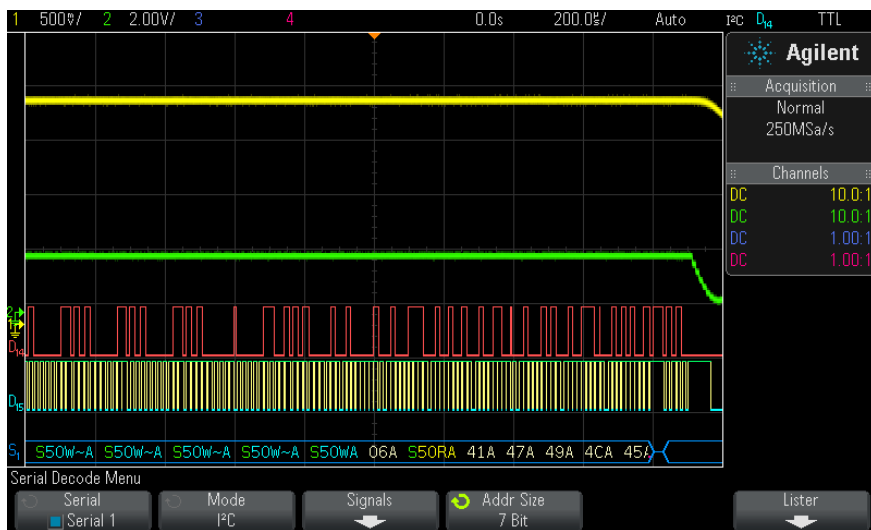

- Angled waveforms show an active bus (inside a packet/frame).
- Mid-level blue lines show an idle bus.
- In the decoded hexadecimal data:
 - Address values appear at the start of a frame.
 - Write addresses appear in light-blue along with the "W" character.
 - Read addresses appear in yellow along with the "R" character.

25 I2C/SPI Triggering and Serial Decode

- Restart addresses appear in green along with the "S" character.
- Data values appear in white.
- "A" indicates Ack (low), "~A" indicates No Ack (high).
- Decoded text is truncated at the end of the associated frame when there is insufficient space within frame boundaries.
- Pink vertical bars indicate you need to expand the horizontal scale (and run again) to see decode.
- Red dots in the decode line indicate that more data can be displayed. Scroll or expand the horizontal scale to view the data.
- Aliased bus values (undersampled or indeterminate) are drawn in pink.
- Unknown bus values (undefined or error conditions) are drawn in red.

Interpreting I2C Lister Data

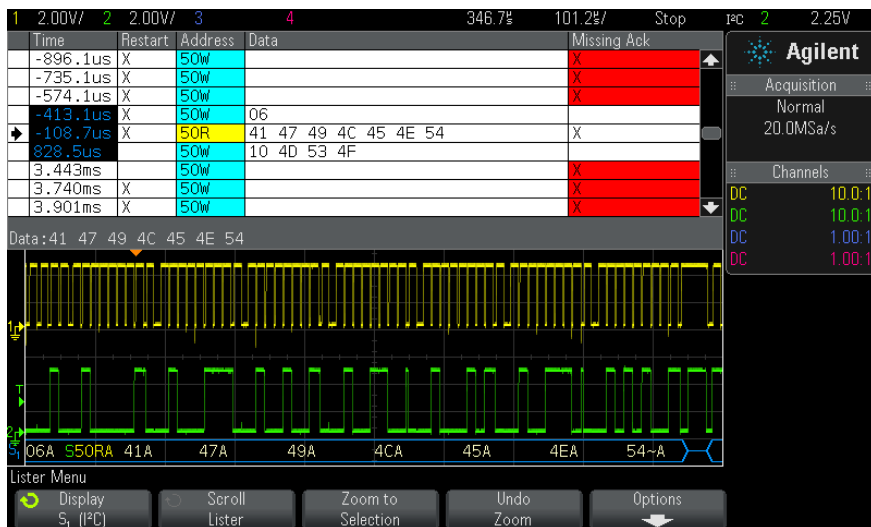

In addition to the standard Time column, the I2C Lister contains these columns:

- Restart – indicated with an "X".
- Address – colored blue for writes, yellow for reads.
- Data – data bytes.

- Missing Ack – indicated by an "X", highlighted in red if an error.

Aliased data is highlighted in pink. When this happens, decrease the horizontal time/div setting and run again.

Searching for I2C Data in the Lister

The oscilloscope's search capability lets you search for (and mark) certain types of I2C data in the Lister. You can use the **[Navigate]** key and controls to navigate through the marked rows.

- 1 With I2C selected as the serial decode mode, press **[Search]**.
- 2 In the Search Menu, press the **Search** softkey; then, turn the Entry knob to select the serial slot (Serial 1 or Serial 2) on which the I2C signal is being decoded.
- 3 Press **Search**; then, select from these options:
 - **Missing Acknowledge** – finds SDA data is high during any Ack SCL clock bit.
 - **Address with no Ack** – finds when the acknowledge of the selected address field is false. The R/W bit is ignored.
 - **Restart** – finds when another start condition occurs before a stop condition.
 - **EEPROM Data Read** – finds EEPROM control byte value 1010xxx on the SDA line, followed by a Read bit and an Ack bit. It then looks for the data value and qualifier set by the Data is softkey and the Data softkeys.
 - **Frame(Start:Address7:Read:Ack:Data)** – finds a read frame on the 17th clock edge if all bits in the pattern match.
 - **Frame(Start:Address7:Write:Ack:Data)** – finds a write frame on the 17th clock edge if all bits in the pattern match.
 - **Frame(Start:Address7:Read:Ack:Data:Ack:Data2)** – finds a read frame on the 26th clock edge if all bits in the pattern match.
 - **Frame(Start:Address7:Write:Ack:Data:Ack:Data2)** – finds a write frame on the 26th clock edge if all bits in the pattern match.

For more information on searching data, see "[Searching Lister Data](#)" on page 128.

For more information on using the **[Navigate]** key and controls, see "[Navigating the Time Base](#)" on page 60.

Setup for SPI Signals

Serial Peripheral Interface (SPI) signals setup consists of connecting the oscilloscope to a clock, MOSI data, MISO data, and framing signal, then setting the threshold voltage level for each input channel, and finally specifying any other signal parameters.

To set up the oscilloscope to capture SPI signals, use the **Signals** softkey which appears in the Serial Decode Menu:

- 1 Press [**Label**] to turn on labels.
- 2 Press [**Serial**].
- 3 Press the **Serial** softkey, turn the Entry knob to select the desired slot (Serial 1 or Serial 2), and press the softkey again to enable decode.
- 4 Press the **Mode** softkey; then, select **SPI** trigger type.
- 5 Press the **Signals** softkey to open the SPI Signals Menu.



- 6 Press the **Clock** softkey to open the SPI Clock Menu.



In the SPI Clock Menu:

- a Press the **Clock** softkey; then, turn the Entry knob to select the channel connected to the SPI serial clock line.

The CLK label for the source channel is automatically set.

- b Press the **Threshold** softkey; then, turn the Entry knob to select the clock signal threshold voltage level.

The threshold voltage level is used in decoding, and it will become the trigger level when the trigger type is set to the selected serial decode slot.

- c Press the slope softkey (↕↘) to select rising edge or falling edge for the selected Clock source.

This determines which clock edge the oscilloscope will use to latch the serial data. When **Display Info** is enabled, the graphic changes to show the current state of the clock signal.

- 7 Press the **MOSI** softkey to open the SPI Master-Out Slave-In Menu.



In the SPI Master-Out Slave-In Menu:

- a Press the **MOSI Data** softkey; then, turn the Entry knob to select the channel that is connected to a SPI serial data line. (If the channel you selected is off, switch it on.)

The MOSI label for the source channel is automatically set.

- b Press the **Threshold** softkey; then, turn the Entry knob to select the MOSI signal threshold voltage level.

The threshold voltage level is used in decoding, and it will become the trigger level when the trigger type is set to the selected serial decode slot.

- 8 (Optional) Press the **MISO** softkey to open the SPI Master-In Slave-Out Menu.



In the SPI Master-In Slave-Out Menu:

- a Press the **MISO Data** softkey; then, turn the Entry knob to select the channel that is connected to a second SPI serial data line. (If the channel you selected is off, switch it on.)

The MISO label for the source channel is automatically set.

- b Press the **Threshold** softkey; then, turn the Entry knob to select the MISO signal threshold voltage level.

The threshold voltage level is used in decoding, and it will become the trigger level when the trigger type is set to the selected serial decode slot.

- 9 Press the **CS** softkey to open the SPI Chip Select Menu.

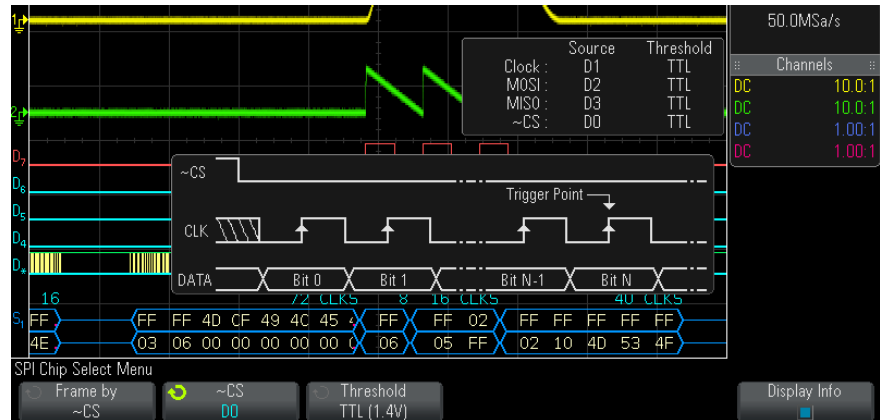

In the SPI Chip Select Menu:

- a Press the **Frame by** softkey to select a framing signal that the oscilloscope will use for determining which clock edge is the first clock edge in the serial stream.

You can set the oscilloscope to trigger during a high chip select (**CS**), a low chip select (**~CS**), or after a **Timeout** period during which the clock signal has been idle.

- If the framing signal is set to **CS** (or **~CS**), the first clock edge as defined, rising or falling, seen after the **CS** (or **~CS**) signal transitions from low to high (or high to low) is the first clock in the serial stream.

Chip Select – Press the **CS** or **~CS** softkey; then, turn the Entry knob to select the channel that is connected to the SPI frame line. The label (**~CS** or **CS**) for the source channel is automatically set. The data pattern and the clock transition must occur during the time when the framing signal is valid. The framing signal must be valid for the entire data pattern.

- If the framing signal is set to **Timeout**, the oscilloscope generates it's own internal framing signal after it sees inactivity on the serial clock line.

Clock Timeout – Select **Clock Timeout** in the **Frame by** softkey, then select the **Timeout** softkey and turn the Entry knob to set the minimum time that the Clock signal must be idle (not transitioning) before the oscilloscope will search for the Data pattern on which to trigger.

The Timeout value can be set anywhere from 100 ns to 10 s.

When you press the **Frame by** softkey, the **Display Info** graphic changes to show timeout selection or the current state of the chip select signal.

- b** Press the **Threshold** softkey; then, turn the Entry knob to select the chip select signal threshold voltage level.

The threshold voltage level is used in decoding, and it will become the trigger level when the trigger type is set to the selected serial decode slot.

When **Display Info** is enabled, information about the selected signal sources and their threshold voltage levels, as well as a waveform diagram, appears on the screen.

SPI Triggering

To set up the oscilloscope to capture SPI signals, see "[Setup for SPI Signals](#)" on page 386.

After the oscilloscope has been set up to capture SPI signals, you can then trigger on a data pattern that occurs at the start of a frame. The serial data string can be specified to be from 4 to 32 bits long.

When you select the SPI trigger type and **Display Info** is enabled, a graphic is displayed showing the current state of the frame signal, clock slope, number of data bits, and data bit values.

- 1** Press [**Trigger**].
- 2** In the Trigger Menu, press the **Trigger** softkey; then, turn the Entry knob to select the serial slot (Serial 1 or Serial 2) on which the SPI signals are being decoded.

25 I2C/SPI Triggering and Serial Decode



- 3 Press the **Trigger Setup** softkey to open the SPI Trigger Setup Menu.



- 4 Press the **Trigger** softkey; then, turn the Entry knob to select the trigger condition:
 - **Master-Out, Slave-In (MOSI) Data** – for triggering on the MOSI data signal.
 - **Master-In, Slave-Out (MISO) Data** – for triggering on the MISO data signal.
- 5 Press the **#Bits** softkey, and turn the Entry knob to set the number of bits (**#Bits**) in the serial data string.

The number of bits in the string can be set anywhere from 4 bits to 64 bits. The data values for the serial string are displayed in the MOSI/MISO Data string in the waveform area.

- 6 For each bit in the MOSI/MISO Data string:
 - a Press the **Bit** softkey; then, turn the Entry knob to select the bit location.

As you rotate the Entry knob, the bit is highlighted in the Data string shown in the waveform area.
 - b Press the **0 1 X** softkey to set the bit selected in the **Bit** softkey to **0** (low), **1** (high), or **X** (don't care).

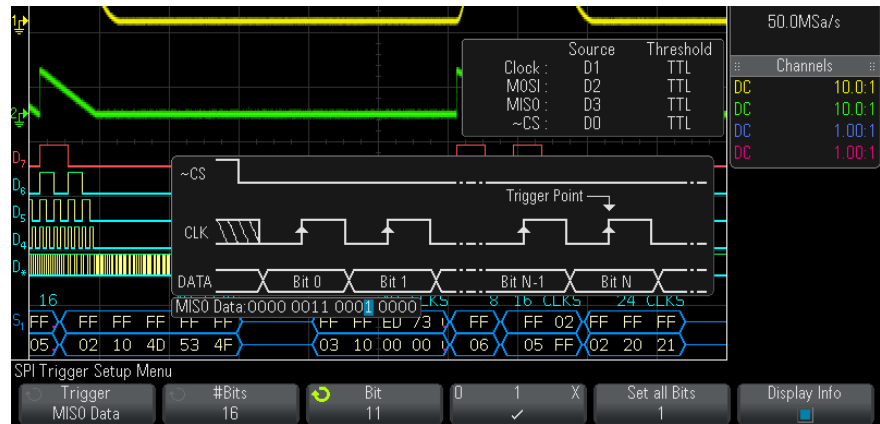

The **Set all Bits** softkey will set all bits in the data string to the value of the **0 1 X** softkey.

NOTE

For SPI decode information see ["SPI Serial Decode"](#) on page 391.

SPI Serial Decode

To set up the oscilloscope to capture SPI signals, see ["Setup for SPI Signals"](#) on page 386.

NOTE

For SPI triggering setup see ["SPI Triggering"](#) on page 389.

To set up SPI serial decode:

- 1 Press [**Serial**] to display the Serial Decode Menu.



- 2 Press the **Word Size** softkey; then, turn the Entry knob to select the number of bits in a word.
- 3 Press the **Bit Order** softkey; then turn the Entry knob to select the bit order, most significant bit first (MSB) or least significant bit first (LSB), used when displaying data in the serial decode waveform and in the Lister.
- 4 If the decode line does not appear on the display, press the **[Serial]** key to turn it on.
- 5 If the oscilloscope is stopped, press the **[Run/Stop]** key to acquire and decode data.

NOTE

If the setup does not produce a stable trigger, the SPI signal may be slow enough that the oscilloscope is AutoTriggering. Press the **[Mode/Coupling]** key, then press the **Mode** softkey to set the trigger mode from **Auto** to **Normal**.

You can use the horizontal **Zoom** window for easier navigation of the acquired data.

- See Also**
- ["Interpreting SPI Decode"](#) on page 393
 - ["Interpreting SPI Lister Data"](#) on page 394
 - ["Searching for SPI Data in the Lister"](#) on page 394

Interpreting SPI Decode

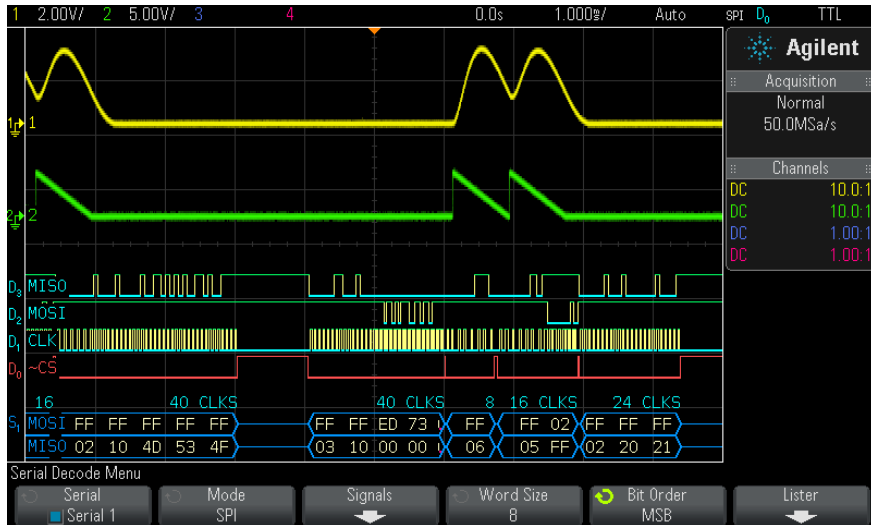

- Angled waveforms show an active bus (inside a packet/frame).
- Mid-level blue lines show an idle bus.
- The number of clocks in a frame appears in light-blue above the frame, to the right.
- Decoded hexadecimal data values appear in white.
- Decoded text is truncated at the end of the associated frame when there is insufficient space within frame boundaries.
- Pink vertical bars indicate you need to expand the horizontal scale (and run again) to see decode.
- Red dots in the decode line indicate that there is data that is not being displayed. Scroll or expand the horizontal scale to view the information.
- Aliased bus values (undersampled or indeterminate) are drawn in pink.
- Unknown bus values (undefined or error conditions) are drawn in red.

Interpreting SPI Lister Data

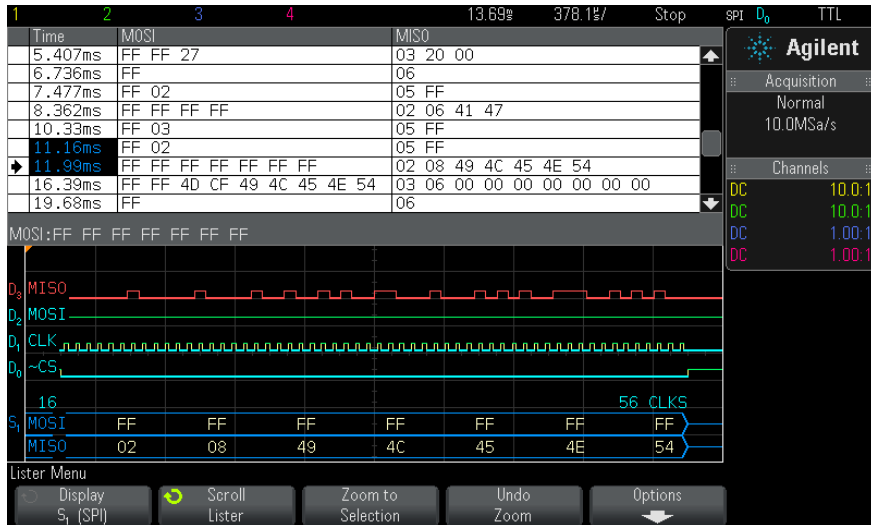

In addition to the standard Time column, the SPI Lister contains these columns:

- Data – data bytes (MOSI and MISO).

Aliased data is highlighted in pink. When this happens, decrease the horizontal time/div setting and run again.

Searching for SPI Data in the Lister

The oscilloscope's search capability lets you search for (and mark) certain types of SPI data in the Lister. You can use the **[Navigate]** key and controls to navigate through the marked rows.

- 1 With SPI selected as the serial decode mode, press **[Search]**.
- 2 In the Search Menu, press the **Search** softkey; then, turn the Entry knob to select the serial slot (Serial 1 or Serial 2) on which the SPI signals are being decoded.
- 3 Press **Search**; then, select from these options:
 - **Master-Out, Slave-In (MOSI) Data** – for searching MOSI data.
 - **Master-In, Slave-Out (MISO) Data** – for searching MISO data.

- 4 Press the **Bits** softkey to open the SPI Bits Search Menu.
- 5 In the SPI Bits Search Menu, use the **Words** softkey to specify the number of words in the data value; then, use the remaining softkeys to enter the hex digit values.

For more information on searching data, see "[Searching Lister Data](#)" on page 128.

For more information on using the [Navigate] key and controls, see "[Navigating the Time Base](#)" on page 60.

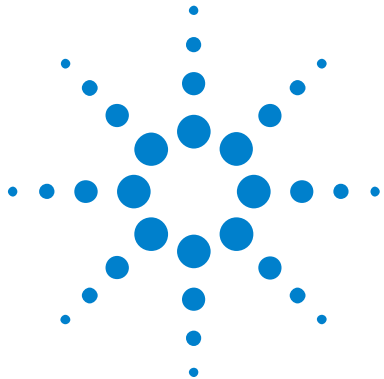

26 I2S Triggering and Serial Decode

Setup for I2S Signals 397

I2S Triggering 400

I2S Serial Decode 403

I2S triggering and serial decode requires Option AUDIO or the DSOX3AUDIO upgrade.

NOTE

Only one I2S serial bus can be decoded at a time.

Setup for I2S Signals

I²S (Inter-IC Sound or Integrated Interchip Sound) signals setup consists of connecting the oscilloscope to the serial clock, word select, and serial data lines and then specifying the input signal threshold voltage levels.

To set up the oscilloscope to capture I2S signals:

- 1 Press [**Label**] to turn on labels.
- 2 Press [**Serial**].
- 3 Press the **Serial** softkey, turn the Entry knob to select the desired slot (Serial 1 or Serial 2), and press the softkey again to enable decode.
- 4 Press the **Mode** softkey; then, select **I2S** trigger type.
- 5 Press the **Signals** softkey to open the I²S Signals Menu.





- 6 For the SCLK (serial clock), WS (word select), and SDATA (serial data) signals:
 - a Connect an oscilloscope channel to the signal in the device under test.
 - b Press the **SCLK**, **WS**, or **SDATA** softkey; then, turn the Entry knob to select the channel for the signal.
 - c Press the corresponding **Threshold** softkey; then, turn the Entry knob to select the signal threshold voltage level.

Set the threshold levels for the SCLK, WS, and SDATA signals to the middle of the signals.

The threshold voltage level is used in decoding, and it will become the trigger level when the trigger type is set to the selected serial decode slot.

The SCLK, WS, and SDATA labels for the source channels are automatically set.

- 7 Press the  Back/Up key to return to the Serial Decode Menu.
- 8 Press the **Bus Config** softkey to open the I²S Bus Configuration Menu and display a diagram showing WS, SCLK, and SDATA signals for the currently specified bus configuration.



- 9 Press the **Word Size** softkey. Turn the Entry knob to match the transmitter word size of the device under test (from 4 to 32 bits).
- 10 Press the **Receiver** softkey. Turn the Entry knob to match the receiver word size of the device under test (from 4 to 32 bits).
- 11 Press the **Alignment** softkey; then, turn the Entry knob to select the desired alignment of the data signal (SDATA). The on-screen diagram changes with your selection.

Standard Alignment – MSB of data for each sample is sent first, LSB is sent last. The MSB appears on the SDATA line one bit clock after the edge of the WS transition.

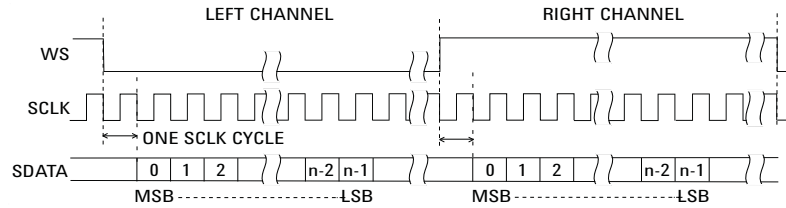

Left-Justified – Data transmission (MSB first) begins at the edge of the WS transition (without the one-bit delay that Standard format employs).

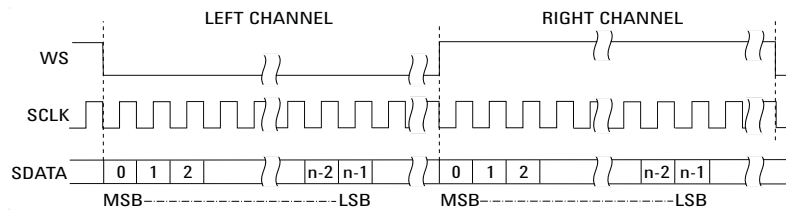

Right-Justified – Data transmission (MSB first) is right-justified to the transition of WS.

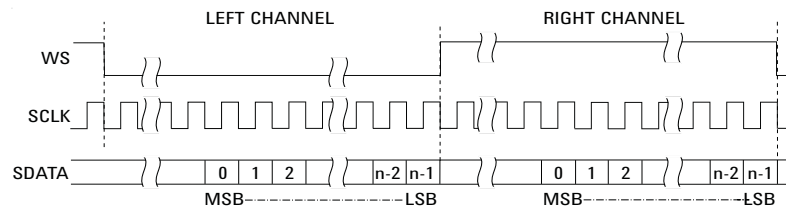

12 Press the **WS Low** softkey; then, turn the Entry knob to select whether WS Low indicates Left or Right channel data. The on-screen diagram changes with your selection.

WS Low = Left Channel – Left-channel data corresponds to WS=low; right-channel data corresponds to WS=high. WS Low=Left is the oscilloscope's default WS setting.

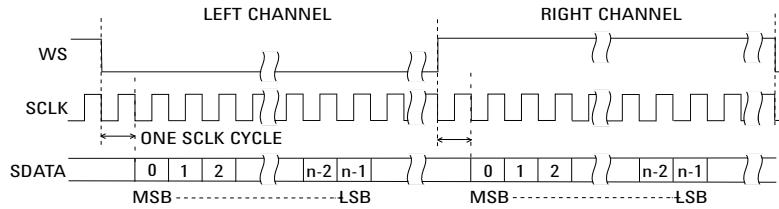

WS Low = Right Channel – Right-channel data corresponds to WS=low; left-channel data corresponds to WS=high.

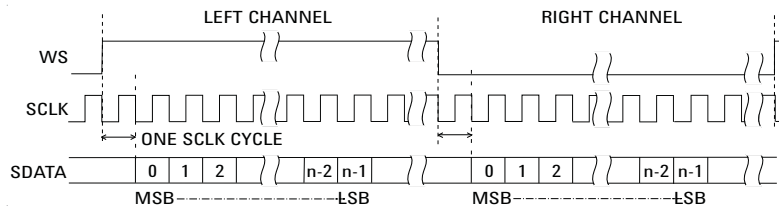

- 13 Press the **SCLK Slope** softkey; then, turn the Entry knob to select the SCLK edge on which data is clocked in your device under test: either rising or falling. The on-screen diagram changes with your selection.

I2S Triggering

To set up the oscilloscope to capture I²S signals, see "[Setup for I2S Signals](#)" on page 397.

After you have set up the oscilloscope to capture I²S signals, you can then trigger on a data value.

- 1 Press [**Trigger**].
- 2 In the Trigger Menu, press the **Trigger** softkey; then, turn the Entry knob to select the serial slot (Serial 1 or Serial 2) on which the I2S signals are being decoded.



- 3 Press the **Trigger Setup** softkey to open the I²S Trigger Setup Menu.



- 4 Press the **Audio** softkey; then, turn the Entry knob to choose to trigger on **Left** channel events, **Right** channel events, or events that occur on **Either** channel.
- 5 Press the **Trigger** softkey and choose a qualifier:
- **Equal** – triggers on the specified audio channel's data word when it equals the specified word.
 - **Not equal** – triggers on any word other than the specified word.
 - **Less than** – triggers when the channel's data word is less than the specified value.
 - **Greater than** – triggers when the channel's data word is greater than the specified value.
 - **In Range** – enter upper and lower values to specify the range in which to trigger.
 - **Out of Range** – enter upper and lower values to specify range in which trigger will not occur.
 - **Increasing value** – triggers when the data value is increasing over time and the specified value is met or exceeded. Set **Trigger** \geq to the data value that must be reached. Set **Armed** \leq to the value to which the data must fall before the trigger circuit is re-armed (ready to trigger again). These settings are made in the current menu when **Base** is **Decimal** or in the Bits submenu when the **Base** is **Binary**. The Armed control reduces triggers due to noise.

This trigger condition is best understood when the digital data transferred over the I2S bus is considered in terms of representing an analog waveform. The figure below shows a plot of sample data transmitted over an I2S bus for one channel. In this example, the oscilloscope will trigger at the 2 points shown since there are two instances in which the data increases from a value below (or at) the "Armed" value to a value greater than (or equal to) the specified "Trigger" value.

If you select an "Armed" value that is equal to or greater than the "Trigger" value, the "Trigger" value will be increased so that it is always greater than the "Armed" value.

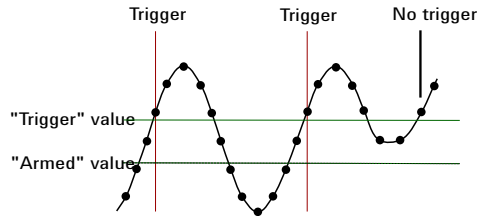

- **Decreasing value** – similar to the description above except the trigger occurs on a decreasing data word value, and the "Armed" value is the value to which the data must rise in order to re-arm the trigger.
- 6 Press the **Base** softkey and select a number base for entering data values:

- **Binary (2's complement).**

When Binary is selected, the **Bits** softkey appears. This softkey opens the I2S Bits Menu for entering data values.

When the trigger qualifier requires a pair of values (as with In Range, Out of Range, Increasing value, or Decreasing value), the first softkey in the I2S Bits Menu lets you select which value of the pair.

In the I2S Bits Menu, press the **Bit** softkey and rotate the Entry knob to select each bit; then, use the **0 1 X** softkey to set each bit value to zero, one, or don't care. You can use the **Set all Bits** softkey to set all bits to the value chosen on the **0 1 X** softkey.

- **Signed decimal.**

When Decimal is selected, the softkey(s) to the right let you enter decimal values with the Entry knob. These softkeys can be **Data**, **<**, **>**, or **Threshold** depending on the selected trigger qualifier.

NOTE

If the setup does not produce a stable trigger, the I2S signal may be slow enough that the oscilloscope is AutoTriggering. Press the **[Mode/Coupling]** key, then press the **Mode** softkey to set the trigger mode from **Auto** to **Normal**.

NOTE

To display I2S serial decode, see ["I2S Serial Decode"](#) on page 403.

I2S Serial Decode

To set up the oscilloscope to capture I2S signals, see ["Setup for I2S Signals"](#) on page 397.

NOTE

For I2S triggering setup see ["I2S Triggering"](#) on page 400.

To set up I2S serial decode:

- 1 Press [**Serial**] to display the Serial Decode Menu.



- 2 Press the **Base** softkey to select the number base in which to display decoded data.
- 3 If the decode line does not appear on the display, press the [**Serial**] key to turn it on.
- 4 If the oscilloscope is stopped, press the [**Run/Stop**] key to acquire and decode data.

NOTE

If the setup does not produce a stable trigger, the I2S signal may be slow enough that the oscilloscope is AutoTriggering. Press the [**Mode/Coupling**] key, then press the **Mode** softkey to set the trigger mode from **Auto** to **Normal**.

You can use the horizontal **Zoom** window for easier navigation of the acquired data.

- See Also**
- ["Interpreting I2S Decode"](#) on page 404
 - ["Interpreting I2S Lister Data"](#) on page 405

- "Searching for I2S Data in the Lister" on page 405

Interpreting I2S Decode

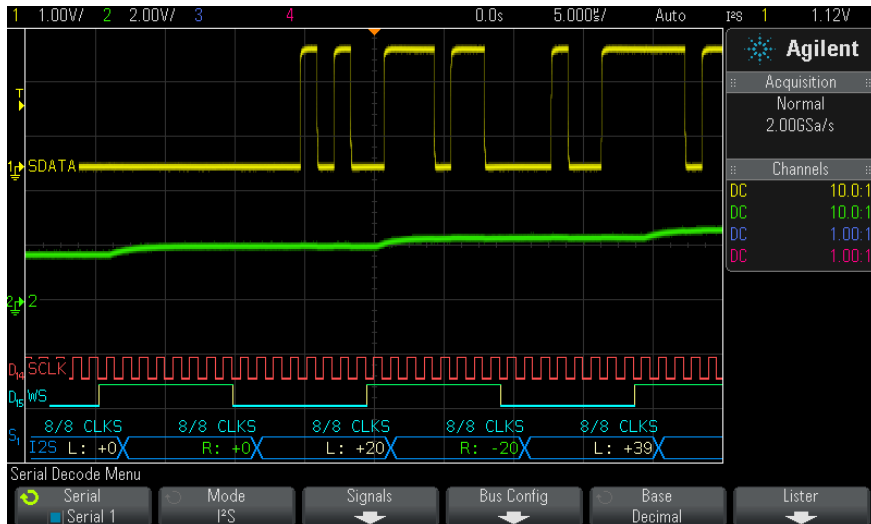

- Angled waveforms show an active bus (inside a packet/frame).
- Mid-level blue lines show an idle bus.
- In the decoded data:
 - Right channel data values appear in green along with the "R:" characters.
 - Left channel data values appear in white along with the "L:" characters.
 - Decoded text is truncated at the end of the associated frame when there is insufficient space within frame boundaries.
- Pink vertical bars indicate you need to expand the horizontal scale (and run again) to see decode.
- Red dots in the decode line indicate that more data can be displayed. Scroll or expand the horizontal scale to view the data.
- Aliased bus values (undersampled or indeterminate) are drawn in pink.
- Unknown bus values (undefined or error conditions) are drawn in red.

NOTE

When the receiver word size is greater than the transmit word size, the decoder fills the least significant bits with zeros and the decoded value does not match the trigger value.

Interpreting I2S Lister Data

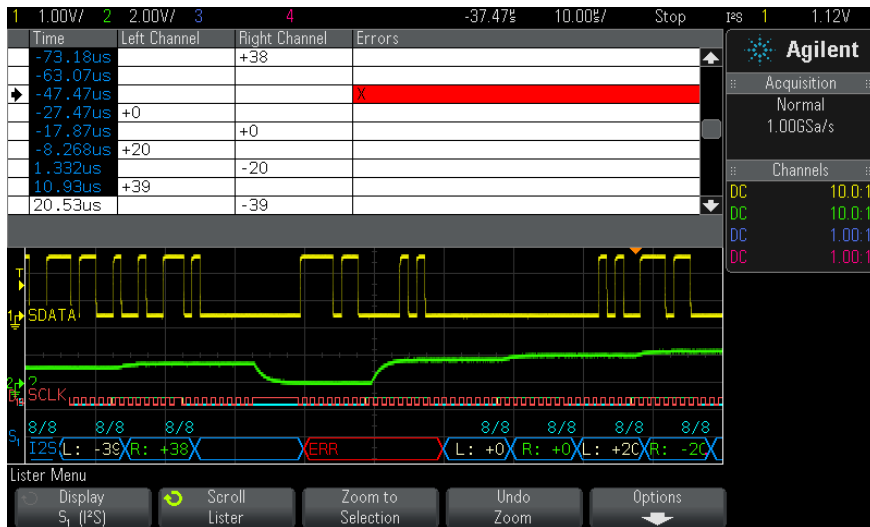

In addition to the standard Time column, the I2S Lister contains these columns:

- Left Channel – displays the left channel data.
- Right Channel – displays the right channel data.
- Errors – highlighted in red and marked with an "X".

Aliased data is highlighted in pink. When this happens, decrease the horizontal time/div setting and run again.

Searching for I2S Data in the Lister

The oscilloscope's search capability lets you search for (and mark) certain types of I2S data in the Lister. You can use the **[Navigate]** key and controls to navigate through the marked rows.

- 1 With I2S selected as the serial decode mode, press **[Search]**.

- 2 In the Search Menu, press the **Search** softkey; then, turn the Entry knob to select the serial slot (Serial 1 or Serial 2) on which the I2S signals are being decoded.
- 3 In the Search Menu, press **Search**; then, select from these options:
 - **= (Equal)** – finds the specified audio channel's data word when it equals the specified word.
 - **!= (Not Equal)** – finds any word other than the specified word.
 - **< (Less than)** – finds when the channel's data word is less than the specified value.
 - **> (Greater than)** – finds when the channel's data word is greater than the specified value.
 - **>< (In Range)** – enter upper and lower values to specify the range to find.
 - **<> (Out of Range)** – enter upper and lower values to specify range not to find.
 - **Errors** – finds all errors.

For more information on searching data, see ["Searching Lister Data"](#) on page 128.

For more information on using the **[Navigate]** key and controls, see ["Navigating the Time Base"](#) on page 60.

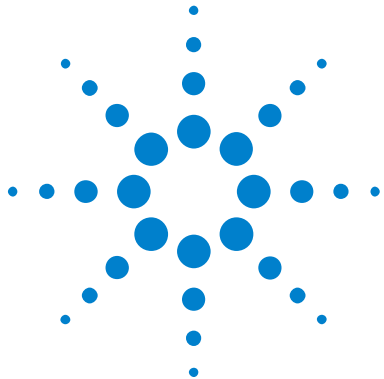

27 MIL-STD-1553/ARINC 429 Triggering and Serial Decode

Setup for MIL-STD-1553 Signals 407

MIL-STD-1553 Triggering 409

MIL-STD-1553 Serial Decode 410

Setup for ARINC 429 Signals 414

ARINC 429 Triggering 415

ARINC 429 Serial Decode 417

MIL-STD-1553/ARINC 429 triggering and serial decode requires Option AERO or the DSOX3AERO upgrade.

The MIL-STD-1553 triggering and decode solution supports bi-phase MIL-STD-1553 signaling by using dual threshold triggering. The solution supports the standard 1553 Manchester II encoding, data rate of 1 Mb/s, and word length of 20 bits.

Setup for MIL-STD-1553 Signals

MIL-STD-1553 signal setup consists of first connecting the oscilloscope to a serial MIL-STD-1553 signal using a differential active probe (the Agilent N2791A is recommended), specifying the signal source, and specifying the high and low trigger threshold voltage levels.

To set up the oscilloscope to capture MIL-STD-1553 signals:

- 1 Press [**Label**] to turn on labels.
- 2 Press [**Serial**].



27 MIL-STD-1553/ARINC 429 Triggering and Serial Decode

- 3 Press the **Serial** softkey, turn the Entry knob to select the desired slot (Serial 1 or Serial 2), and press the softkey again to enable decode.
- 4 Press the **Mode** softkey; then, select **MIL-STD-1553** decode mode.
- 5 Press the **Signals** softkey to open the MIL-STD-1553 Signals Menu.



- 6 Press the **Source** softkey to select the channel connected to the MIL-STD-1553 signal line.
The label for the MIL-STD-1553 source channel is automatically set.
- 7 Press the  Back/Up key to return to the Serial Decode Menu.
- 8 Press the **Auto Setup** softkey which performs these actions:
 - Sets the probe attenuation factor of the input Source channel to 10:1.
 - Sets upper and lower thresholds to a voltage value equal to $\pm 1/3$ division based on the current V/div setting.
 - Turns off trigger noise reject.
 - Turns on Serial Decode.
 - Sets the trigger type to MIL-1553.
- 9 If the upper and lower thresholds are not set correctly by **Auto Setup**, press the **Signals** softkey to return to the MIL-STD-1553 Signals Menu. Then:
 - Press the **High Threshold** softkey; then, turn the Entry knob to set the high trigger threshold voltage level.
 - Press the **Low Threshold** softkey; then, turn the Entry knob to set the low trigger threshold voltage level.

The threshold voltage levels are used in decoding and will become the trigger levels when the trigger type is set to the selected serial decode slot.

MIL-STD-1553 Triggering

To set up the oscilloscope to capture a MIL-STD-1553 signal, see ["Setup for MIL-STD-1553 Signals"](#) on page 407.

To set up a MIL-STD-1553 trigger:

- 1 Press **[Trigger]**.
- 2 In the Trigger Menu, press the **Trigger** softkey; then, turn the Entry knob to select the serial slot (Serial 1 or Serial 2) on which the MIL-STD-1553 signal is being decoded.



- 3 Press the **Trigger** softkey; then, turn the Entry knob to select the trigger condition:
 - **Data Word Start** – triggers on the start of a Data word (at the end of a valid Data Sync pulse).
 - **Data Word Stop** – triggers on the end of a Data word.
 - **Command/Status Word Start** – triggers on the start of Command/Status word (at the end of a valid C/S Sync pulse).
 - **Command/Status Word Stop** – triggers on the end of a Command/Status word.
 - **Remote Terminal Address** – triggers if the RTA of the Command/Status word matches the specified value.

When this option is selected, the **RTA** softkey becomes available and lets you select the hex Remote Terminal Address value to trigger on. If you select 0xXX (don't cares), the oscilloscope will trigger on any RTA.

- **Remote Terminal Address + 11 Bits** – triggers if the RTA and the remaining 11 bits match the specified criteria.

When this option is selected, these softkeys become available:

- The **RTA** softkey lets you select the hex Remote Terminal Address value.
- The **Bit Time** softkey lets you select the bit time position.

27 MIL-STD-1553/ARINC 429 Triggering and Serial Decode

- The **01X** softkey lets you set the bit time position value as a 1, 0, or X (don't care).
- **Parity Error** – triggers if the (odd) parity bit is incorrect for the data in the word.
- **Sync Error** – triggers if an invalid Sync pulse is found.
- **Manchester Error** – triggers if a Manchester encoding error is detected.

NOTE

For MIL-STD-1553 decode information see "[MIL-STD-1553 Serial Decode](#)" on page 410.

MIL-STD-1553 Serial Decode

To set up the oscilloscope to capture MIL-STD-1553 signals, see "[Setup for MIL-STD-1553 Signals](#)" on page 407.

NOTE

For MIL-STD-1553 triggering setup see "[MIL-STD-1553 Triggering](#)" on page 409.

To set up MIL-STD-1553 serial decode:

- 1 Press [**Serial**] to display the Serial Decode Menu.



- 2 Use the **Base** softkey to select between hexadecimal and binary display of the decoded data.

The base setting is used for the display of the remote terminal address and the data, in both the decode line and in the Lister.

- 3 If the decode line does not appear on the display, press the [**Serial**] key to turn it on.
- 4 If the oscilloscope is stopped, press the [**Run/Stop**] key to acquire and decode data.

You can use the horizontal **Zoom** window for easier navigation of the decoded data.

- See Also**
- "Interpreting MIL-STD-1553 Decode" on page 411
 - "Interpreting MIL-STD-1553 Lister Data" on page 412
 - "Searching for MIL-STD-1553 Data in the Lister" on page 413

Interpreting MIL-STD-1553 Decode

To display serial decode information, you must press **[Run]** or **[Single]** after switching on serial decode.



The MIL-STD-1553 decode display is color coded as follows:

- Command and Status decoded data is colored green, with the Remote Terminal Address (5 bits of data) being displayed first, then the text "C/S:", followed by the value of the remaining 11 bits of a Command/Status word.
- Data word decoded data is colored white, preceded by the text "D:".
- Command/Status or Data words with a Parity error have the decode text displayed in red instead of green or white.

27 MIL-STD-1553/ARINC 429 Triggering and Serial Decode

- SYNC errors are displayed with the word "SYNC" within red angle brackets.
- Manchester encoding errors are displayed with the word "MANCH" within blue angle brackets (blue instead of red because a valid Sync pulse started the word).

Interpreting MIL-STD-1553 Lister Data

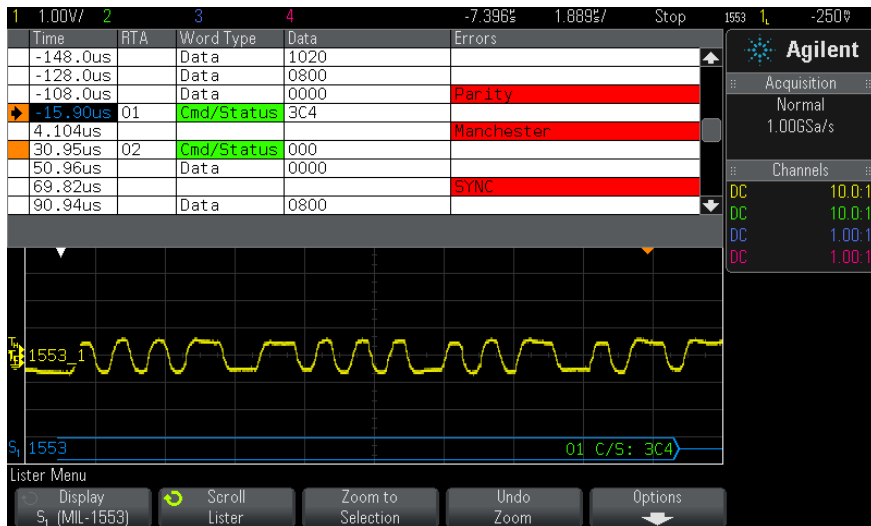

In addition to the standard Time column, the MIL-STD-1553 Lister contains these columns:

- RTA – displays the Remote Terminal Address for Command/Status words, nothing for Data words.
- Word Type – "Cmd/Status" for Command/Status words, "Data" for Data words. For Command/Status words the background color is green to match the decode text color.
- Data – the 11 bits after the RTA for Command/Status words, or the 16 bits of a Data word.
- Errors – "Sync", "Parity", or "Manchester" errors as appropriate. The background color is red to indicate an error.

Aliased data is highlighted in pink. When this happens, decrease the horizontal time/div setting and run again.

Searching for MIL-STD-1553 Data in the Lister

The oscilloscope's search capability lets you search for (and mark) certain types of MIL-STD-1553 data in the Lister. You can use the **[Navigate]** key and controls to navigate through the marked rows.

- 1 With MIL-STD-1553 selected as the serial decode mode, press **[Search]**.
- 2 In the Search Menu, press the **Search** softkey; then, turn the Entry knob to select the serial slot (Serial 1 or Serial 2) on which the MIL-STD-1553 signal is being decoded.
- 3 Press **Search**; then, select from these options:
 - **Data Word Start** – finds the start of a Data word (at the end of a valid Data Sync pulse).
 - **Command/Status Word Start** – finds the start of Command/Status word (at the end of a valid C/S Sync pulse).
 - **Remote Terminal Address** – finds the Command/Status word whose RTA matches the specified value. The value is specified in hex.

When this option is selected, the **RTA** softkey becomes available and lets you select the hex Remote Terminal Address value to find.

- **Remote Terminal Address + 11 Bits** – finds the RTA and the remaining 11 bits that match the specified criteria.

When this option is selected, these softkeys become available:

- The **RTA** softkey lets you select the hex Remote Terminal Address value.
- The **Bit Time** softkey lets you select the bit time position.
- The **0 1 X** softkey lets you set the bit time position value as a 1, 0, or X (don't care).
- **Parity Error** – finds (odd) parity bits that are incorrect for the data in the word.
- **Sync Error** – finds invalid Sync pulses.
- **Manchester Error** – finds Manchester encoding errors.

For more information on searching data, see ["Searching Lister Data"](#) on page 128.

For more information on using the **[Navigate]** key and controls, see "Navigating the Time Base" on page 60.

Setup for ARINC 429 Signals

Setup consists of first connecting the oscilloscope to a ARINC 429 signal using a differential active probe (the Agilent N2791A is recommended), then using the Signals Menu to specify the signal source, the high and low trigger threshold voltage levels, the signal speed, and the signal type.

To set up the oscilloscope to capture ARINC 429 signals:

- 1 Press **[Label]** to turn on labels.
- 2 Press **[Serial]**.
- 3 Press the **Serial** softkey, turn the Entry knob to select the desired slot (Serial 1 or Serial 2), and press the softkey again to enable decode.
- 4 Press the **Mode** softkey; then, select **ARINC 429** decode mode.
- 5 Press the **Signals** softkey to open the ARINC 429 Signals Menu.



- 6 Press **Source**; then, select the channel for the ARINC 429 signal.
The label for the ARINC 429 source channel is automatically set.
- 7 Press the **Speed** softkey to open the ARINC 429 Speed Menu.



- 8 Press the **Speed** softkey and specify the speed of the ARINC 429 signal:
 - **High** – 100 kb/s.
 - **Low** – 12.5 kb/s.
 - **User Defined** – if selected, press the **User Baud** softkey and turn the Entry knob to specify the speed.
- 9 Press the **Back/Up** key (with a circular arrow icon) to return to the ARINC 429 Signals Menu.

10 Press the **Signal Type** softkey and specify the signal type of the ARINC 429 signal:

- **Line A (non-inverted).**
- **Line B (inverted).**
- **Differential (A-B).**

11 Press the **Auto Setup** softkey to automatically set these options for decoding and triggering on ARINC 429 signals:

- High Trigger Threshold: 3.0 V.
- Low Trigger Threshold: -3.0 V.
- Noise Reject: Off.
- Probe Attenuation: 10.0.
- Vertical Scale: 4 V/div.
- Serial Decode: On.
- Base: Hex.
- Word Format: Label/SDI/Data/SSM.
- Trigger: currently active serial bus.
- Trigger Mode: Word Start.

12 If the high and low thresholds are not set correctly by **Auto Setup**:

- Press the **High Threshold** softkey; then, turn the Entry knob to set the high trigger threshold voltage level.
- Press the **Low Threshold** softkey; then, turn the Entry knob to set the low trigger threshold voltage level.

The threshold voltage levels are used in decoding and will become the trigger levels when the trigger type is set to the selected serial decode slot.

ARINC 429 Triggering

To set up the oscilloscope to capture a ARINC 429 signal, see "[Setup for ARINC 429 Signals](#)" on page 414.

After setting up the oscilloscope to capture a ARINC 429 signal:

1 Press [**Trigger**].

- In the Trigger Menu, press the **Trigger** softkey; then, turn the Entry knob to select the serial slot (Serial 1 or Serial 2) on which the ARINC 429 signal is being decoded.



- Press the **Trigger:** softkey; then, turn the Entry knob to select the trigger condition:
 - Word Start** – triggers on the start of a word.
 - Word Stop** – triggers at the end of a word.
 - Label** – triggers on the specified label value.
 - Label + Bits** – triggers on the label and the other word fields as specified.
 - Label Range** – triggers on a label following in a min/max range.
 - Parity Error** – triggers on words with a parity error.
 - Word Error** – triggers on an intra-word coding error.
 - Gap Error** – triggers on an inter-word gap error.
 - Word or Gap Error** – triggers on either a Word or Gap Error.
 - All Errors** – triggers on any of the above errors.
 - All Bits (Eye)** – triggers on any bit, which will therefore form an eye diagram.
 - All 0 Bits** – triggers on any bit with a value of zero.
 - All 1 Bits** – triggers on any bit with a value of one.
- If you select the **Label** or **Label + Bits** condition, use the **Label** softkey to specify the label value.

Label values are always displayed in octal.

- If you select the **Label + Bits** condition, use the **Bits** softkey and submenu to specify the bit values:



Use the **Define** softkey to select SDI, Data, or SSM. The SDI or SSM selections may not be available, depending on word format selection in the Serial Decode Menu.

Use the **Bit** softkey to select the bit to change.

Use the **0 1 X** softkey to set the bit value.

Use the **Set all Bits** softkey to set all bit values to 0, 1, or X.

- 6 If you select the **Label Range** condition, use the **Label Min** and **Label Max** softkeys to specify the ends of the range.

Again, label values are always displayed in octal.

You can use the **Zoom** mode for easier navigation of the decoded data.

NOTE

To display ARINC 429 serial decode, see "[ARINC 429 Serial Decode](#)" on page 417.

ARINC 429 Serial Decode

To set up the oscilloscope to capture ARINC 429 signals, see "[Setup for ARINC 429 Signals](#)" on page 414.

NOTE

For ARINC 429 triggering set up see "[ARINC 429 Triggering](#)" on page 415.

To set up ARINC 429 serial decode:

- 1 Press [**Serial**] to display the Serial Decode Menu.



- 2 In the submenu accessed by the **Settings** softkey, you can use the **Base** softkey to select between hexadecimal and binary display of the decoded data.

The base setting is used for *data* display in both the decode line and in the Lister.

Label values are always displayed in octal, and SSM and SDI values are always displayed in binary.

3 Press the **Word Format** softkey and specify the word decode format:

- **Label/SDI/Data/SSM:**

- Label - 8 bits.
- SDI - 2 bits.
- Data - 19 bits.
- SSM - 2 bits.

- **Label/Data/SSM:**

- Label - 8 bits.
- Data - 21 bits.
- SSM - 2 bits.

- **Label/Data:**

- Label - 8 bits.
- Data - 23 bits.

4 If the decode line does not appear on the display, press the **[Serial]** key to turn it on.

5 If the oscilloscope is stopped, press the **[Run/Stop]** key to acquire and decode data.

NOTE

If the setup does not produce a stable trigger, the ARINC 429 signal may be slow enough that the oscilloscope is AutoTriggering. Press the **[Mode/Coupling]** key, then press the **Mode** softkey to set the trigger mode from **Auto** to **Normal**.

You can use the horizontal **Zoom** window for easier navigation of the decoded data.

- See Also**
- ["Interpreting ARINC 429 Decode"](#) on page 419
 - ["ARINC 429 Totalizer"](#) on page 420
 - ["Interpreting ARINC 429 Lister Data"](#) on page 421
 - ["Searching for ARINC 429 Data in the Lister"](#) on page 421

Interpreting ARINC 429 Decode

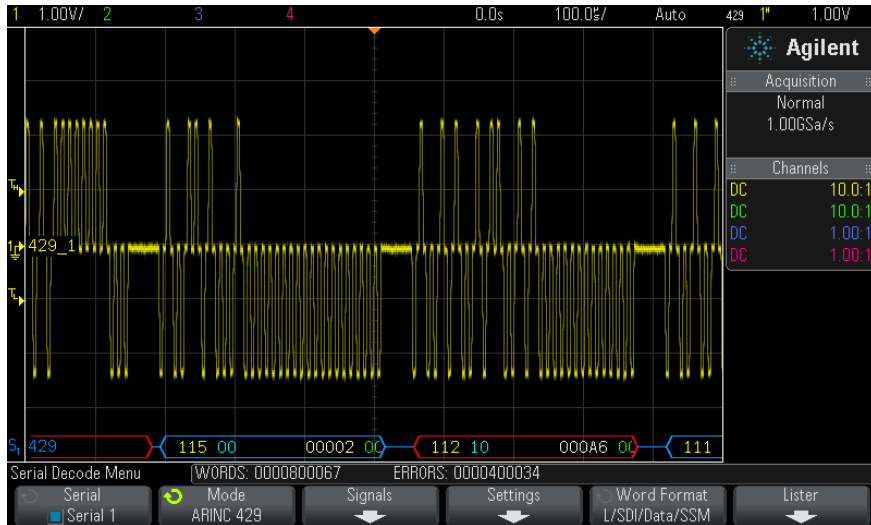

Depending on the selected word decode format, the ARINC 429 decode display is color coded as follows:

- When the decode format is Label/SDI/Data/SSM:
 - Label (yellow) (8 bits) – displayed in octal.
 - SDI (blue) (2 bits) – displayed in binary.
 - Data (white, red if parity error) (19 bits) – displayed in the selected Base.
 - SSM (green) (2 bits) – displayed in binary.
- When the decode format is Label/Data/SSM:
 - Label (yellow) (8 bits) – displayed in octal.
 - Data (white, red if parity error) (21 bits) – displayed in the selected Base.
 - SSM (green) (2 bits) – displayed in binary.
- When the decode format is Label/Data:
 - Label (yellow) (8 bits) – displayed in octal.

- Data (white, red if parity error) (23 bits) – displayed in the selected Base.

The Label bits are displayed in the same order as they are received on the wire. For the Data, SSM, and SDI bits, the fields are displayed in the order received; however, the bits within those fields are displayed in reverse order. In other words, the non-Label fields are displayed in the ARINC 429 Word Format, while the bits for those fields have the opposite transfer order on the wire.

ARINC 429 Totalizer

The ARINC 429 totalizer measures the total ARINC 429 words and errors.



The totalizer is always running, counting words and errors, and is displayed whenever ARINC 429 decode is displayed. The totalizer counts even when the oscilloscope is stopped (not acquiring data).

Pressing the **[Run/Stop]** key does not affect the totalizer.

When an overflow condition occurs, the counter displays **OVERFLOW**.

The counters can be reset to zero by pressing the **Reset ARINC 429 Counters** softkey (in the decode **Settings** menu).

Interpreting ARINC 429 Lister Data

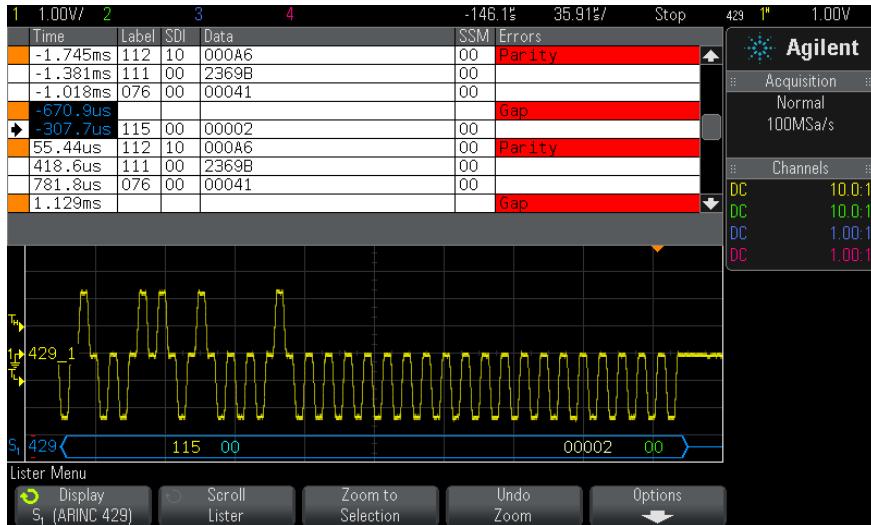

In addition to the standard Time column, the ARINC 429 Lister contains these columns:

- Label – the 5-bit label value in octal format.
- SDI – the bit values (if included in the word decode format).
- Data – the data value in binary or hex, depending on the base setting.
- SSM – the bit values (if included in the word decode format).
- Errors – highlighted in red. Errors can be Parity, Word, or Gap.

Aliased data is highlighted in pink. When this happens, decrease the horizontal time/div setting and run again.

Searching for ARINC 429 Data in the Lister

The oscilloscope's search capability lets you search for (and mark) certain types of ARINC 429 data in the Lister. You can use the **[Navigate]** key and controls to navigate through the marked rows.

- 1 With ARINC 429 selected as the serial decode mode, press **[Search]**.

- 2 In the Search Menu, press the **Search** softkey; then, turn the Entry knob to select the serial slot (Serial 1 or Serial 2) on which the ARINC 429 signal is being decoded.
- 3 Press **Search**; then, select from these options:
 - **Label** – finds the specified label value.
Label values are always displayed in octal.
 - **Label + Bits** – finds the label and the other word fields as specified.
 - **Parity Error** – finds words with a parity error.
 - **Word Error** – finds an intra-word coding error.
 - **Gap Error** – finds an inter-word gap error.
 - **Word or Gap Error** – finds either a Word or Gap Error.
 - **All Errors** – finds any of the above errors.

For more information on searching data, see "[Searching Lister Data](#)" on page 128.

For more information on using the [**Navigate**] key and controls, see "[Navigating the Time Base](#)" on page 60.



28 UART/RS232 Triggering and Serial Decode

Setup for UART/RS232 Signals 423

UART/RS232 Triggering 425

UART/RS232 Serial Decode 427

UART/RS232 triggering and serial decode requires Option COMP or the DSOX3COMP upgrade.

Setup for UART/RS232 Signals

To set up the oscilloscope to capture UART/RS232 signals:

- 1 Press [**Label**] to turn on labels.
- 2 Press [**Serial**].
- 3 Press the **Serial** softkey, turn the Entry knob to select the desired slot (Serial 1 or Serial 2), and press the softkey again to enable decode.
- 4 Press the **Mode** softkey; then, select **UART/RS232** trigger type.
- 5 Press the **Signals** softkey to open the UART/RS232 Signals Menu.



- 6 For both the Rx and Tx signals:
 - a Connect an oscilloscope channel to the signal in the device under test.
 - b Press the **Rx** or **Tx** softkey; then, turn the Entry knob to select the channel for the signal.
 - c Press the corresponding **Threshold** softkey; then, turn the Entry knob to select the signal threshold voltage level.

The threshold voltage level is used in decoding, and it will become the trigger level when the trigger type is set to the selected serial decode slot.

The RX and TX labels for the source channels are automatically set.

- 7 Press the  Back/Up key to return to the Serial Decode Menu.
- 8 Press the **Bus Config** softkey to open the UART/RS232 Bus Configuration Menu.



Set the following parameters.

- a **#Bits** – Set the number of bits in the UART/RS232 words to match your device under test (selectable from 5-9 bits).
- b **Parity** – Choose odd, even, or none, based on your device under test.
- c **Baud** – Press the **Baud Rate** softkey, then press the **Baud** softkey and select a baud rate to match the signal in your device under test. If the desired baud rate is not listed, select **User Defined** on the Baud softkey; then, select the desired baud rate using the **User Baud** softkey.

You can set the UART baud rate from 1.2 kb/s to 8.0000 Mb/s in increments of 100 b/s.

- d **Polarity** – Select idle low or idle high to match your device under test's state when at idle. For RS232 select idle low.
- e **Bit Order** – Select whether the most significant bit (MSB) or the least significant bit (LSB) is presented after the start bit in the signal from your device under test. For RS232 select LSB.

NOTE

In the serial decode display, the most significant bit is always displayed on the left regardless of how Bit Order is set.

UART/RS232 Triggering

To set up the oscilloscope to capture UART/RS-232 signals, see "[Setup for UART/RS232 Signals](#)" on page 423.

To trigger on a UART (Universal Asynchronous Receiver/Transmitter) signal connect the oscilloscope to the Rx and Tx lines and set up a trigger condition. RS232 (Recommended Standard 232) is one example of a UART protocol.

- 1 Press [**Trigger**].
- 2 In the Trigger Menu, press the **Trigger** softkey; then, turn the Entry knob to select the serial slot (Serial 1 or Serial 2) on which the UART/RS232 signals are being decoded.



- 3 Press the **Trigger Setup** softkey to open the UART/RS232 Trigger Setup Menu.



- 4 Press the **Base** softkey to select Hex or ASCII as the base displayed on the Data softkey in the UART/RS232 Trigger Setup Menu.

Note that the setting of this softkey does not affect the selected base of the decode display.

- 5 Press the **Trigger** softkey and set up the desired trigger condition:
 - **Rx Start Bit** – The oscilloscope triggers when a start bit occurs on Rx.

- **Rx Stop Bit** – Triggers when a stop bit occurs on Rx. The trigger will occur on the first stop bit. This is done automatically whether the device under test uses 1, 1.5, or 2 stop bits. You do not need to specify the number of stop bits used by the device Under test.
 - **Rx Data** – Triggers on a data byte that you specify. For use when the device under test data words are from 5 to 8 bits in length (no 9th (alert) bit).
 - **Rx 1:Data** – For use when the device under test data words are 9 bits in length including the alert bit (the 9th bit). Triggers only when the 9th (alert) bit is 1. The specified data byte applies to the least significant 8 bits (excludes the 9th (alert) bit).
 - **Rx 0:Data** – For use when the device under test data words are 9 bits in length including the alert bit (the 9th bit). Triggers only when the 9th (alert) bit is 0. The specified data byte applies to the least significant 8 bits (excludes the 9th (alert) bit).
 - **Rx X:Data** – For use when the device under test data words are 9 bits in length including the alert bit (the 9th bit). Triggers on a data byte that you specify regardless of the value of the 9th (alert) bit. The specified data byte applies to the least significant 8 bits (excludes the 9th (alert) bit).
 - Similar choices are available for Tx.
 - **Rx or Tx Parity Error** – Triggers on a parity error based on the parity you have set in the Bus Configuration Menu.
- 6 If you choose a trigger condition that includes "**Data**" in its description (for example: **Rx Data**), then press the **Data is** softkey, and choose an equality qualifier. You can choose equal to, not equal to, less than, or greater than a specific data value.
 - 7 Use the **Data** softkey to choose the data value for your trigger comparison. This works in conjunction with the **Data is** softkey.
 - 8 Optional: The **Burst** softkey lets you trigger on the Nth frame (1-4096) after an idle time you select. All trigger conditions must be met for the trigger to occur.
 - 9 If **Burst** is selected, an idle time (1 μ s to 10 s) can be specified so that the oscilloscope will look for a trigger condition only after the idle time has past. Press the **Idle** softkey and rotate the Entry knob to set an idle time.

NOTE

If the setup does not produce a stable trigger, the UART/RS232 signals may be slow enough that the oscilloscope is AutoTriggering. Press the **[Mode/Coupling]** key, then press the **Mode** softkey to set the trigger mode from **Auto** to **Normal**.

NOTE

To display UART/RS232 serial decode, see "[UART/RS232 Serial Decode](#)" on page 427.

UART/RS232 Serial Decode

To set up the oscilloscope to capture UART/RS232 signals, see "[Setup for UART/RS232 Signals](#)" on page 423.

NOTE

For UART/RS232 triggering setup see "[UART/RS232 Triggering](#)" on page 425.

To set up UART/RS232 serial decode:

- 1 Press **[Serial]** to display the Serial Decode Menu.



- 2 Press **Settings**.
- 3 In the UART/RS232 Settings Menu, press the **Base** softkey to select the base (hex, binary, or ASCII) in which decoded words are displayed.



- When displaying words in ASCII, the 7-bit ASCII format is used. Valid ASCII characters are between 0x00 and 0x7F. To display in ASCII you must select at least 7 bits in the Bus Configuration. If ASCII is selected and the data exceeds 0x7F, the data is displayed in hex.

- When **#Bits** is set to 9 in the UART/RS232 Bus Configuration Menu, the 9th (alert) bit is displayed directly to the left of the ASCII value (which is derived from the lower 8 bits).
- 4 Optional: Press the **Framing** softkey and select a value. In the decode display, the chosen value will be displayed in light blue. However, if a parity error occurs the data will be displayed in red.
 - 5 If the decode line does not appear on the display, press the **[Serial]** key to turn it on.
 - 6 If the oscilloscope is stopped, press the **[Run/Stop]** key to acquire and decode data.

NOTE

If the setup does not produce a stable trigger, the UART/RS232 signals may be slow enough that the oscilloscope is AutoTriggering. Press the **[Mode/Coupling]** key, then press the **Mode** softkey to set the trigger mode from **Auto** to **Normal**.

You can use the horizontal **Zoom** window for easier navigation of the acquired data.

- See Also**
- ["Interpreting UART/RS232 Decode"](#) on page 429
 - ["UART/RS232 Totalizer"](#) on page 430
 - ["Interpreting UART/RS232 Lister Data"](#) on page 431
 - ["Searching for UART/RS232 Data in the Lister"](#) on page 431

Interpreting UART/RS232 Decode

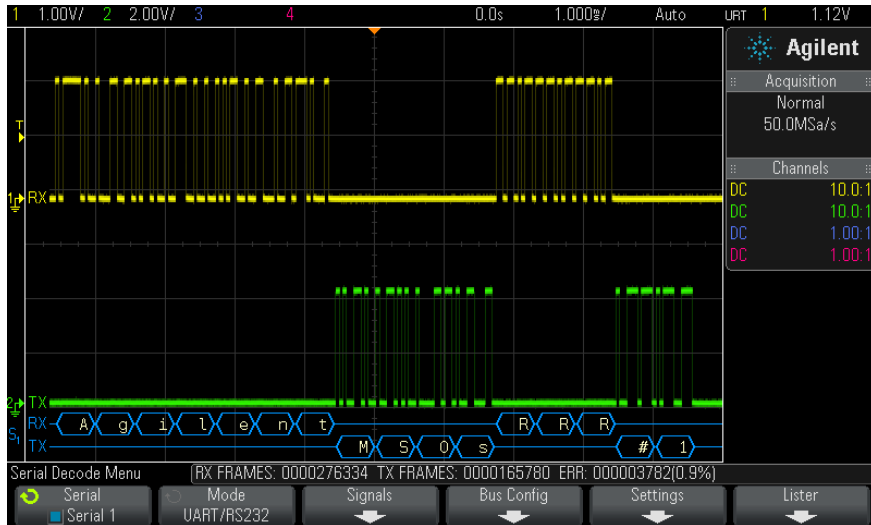

- Angled waveforms show an active bus (inside a packet/frame).
- Mid-level blue lines show an idle bus.
- When using 5-8 bit formats, the decoded data is displayed in white (in binary, hex, or ASCII).
- When using the 9 bit format, all data words are displayed in green, including the 9th bit. The 9th bit is displayed on the left.
- When a data word value is selected for framing, it is displayed in light blue. When using 9-bit data words, the 9th bit will also be displayed in light blue.
- Decoded text is truncated at the end of the associated frame when there is insufficient space within frame boundaries.
- Pink vertical bars indicate you need to expand the horizontal scale (and run again) to see decode.
- When the horizontal scale setting does not permit the display of all available decoded data, red dots will appear in the decoded bus to mark the location of hidden data. Expand the horizontal scale to allow the data to display.
- An unknown (undefined) bus is shown in red.

- A parity error will cause the associated data word to be shown in red, which includes the 5-8 data bits and the optional 9th bit.

UART/RS232 Totalizer

The UART/RS232 totalizer consists of counters that provide a direct measure of bus quality and efficiency. The totalizer appears on screen whenever UART/RS232 Decode is ON in the Serial Decode Menu.



The totalizer is running, counting frames and calculating the percentage of error frames, even when the oscilloscope is stopped (not acquiring data).

The ERR (error) counter is a count of Rx and Tx frames with parity errors. The TX FRAMES and RX FRAMES counts include both normal frames and frames with parity errors. When an overflow condition occurs, the counter displays **OVERFLOW**.

The counters can be reset to zero by pressing the **Reset UART Counters** softkey in the UART/RS232 Settings Menu.

Interpreting UART/RS232 Lister Data

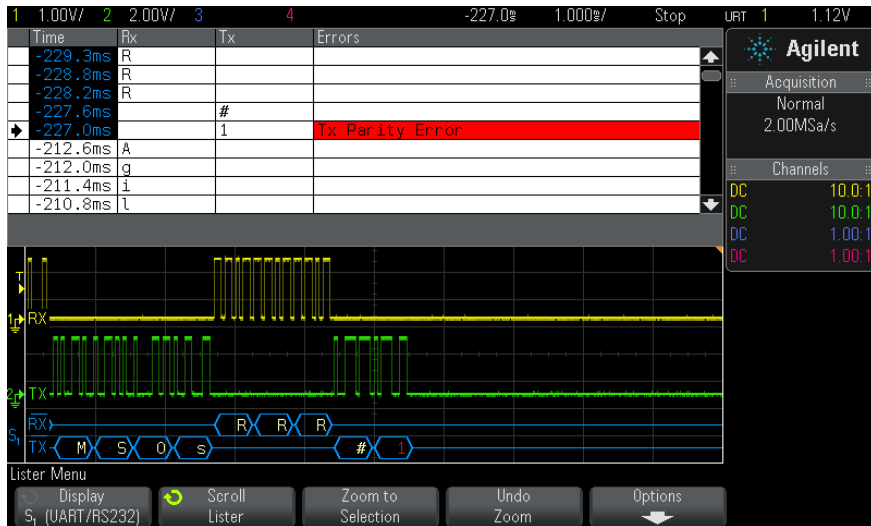

In addition to the standard Time column, the UART/RS232 Lister contains these columns:

- Rx – receive data.
- Tx – transmit data.
- Errors – highlighted in red, Parity Error or Unknown Error.

Aliased data is highlighted in pink. When this happens, decrease the horizontal time/div setting and run again.

Searching for UART/RS232 Data in the Lister

The oscilloscope's search capability lets you search for (and mark) certain types of UART/RS232 data in the Lister. You can use the **[Navigate]** key and controls to navigate through the marked rows.

- 1 With UART/RS232 selected as the serial decode mode, press **[Search]**.
- 2 In the Search Menu, press the **Search** softkey; then, turn the Entry knob to select the serial slot (Serial 1 or Serial 2) on which the UART/RS232 signals are being decoded.
- 3 In the Search Menu, press **Search**; then, select from these options:

- **Rx Data** – Finds a data byte that you specify. For use when the DUT data words are from 5 to 8 bits in length (no 9th (alert) bit).
- **Rx 1:Data** – For use when the DUT data words are 9 bits in length including the alert bit (the 9th bit). Finds only when the 9th (alert) bit is 1. The specified data byte applies to the least significant 8 bits (excludes the 9th (alert) bit)
- **Rx 0:Data** – For use when the DUT data words are 9 bits in length including the alert bit (the 9th bit). Finds only when the 9th (alert) bit is 0. The specified data byte applies to the least significant 8 bits (excludes the 9th (alert) bit).
- **Rx X:Data** – For use when the DUT data words are 9 bits in length including the alert bit (the 9th bit). Finds a data byte that you specify regardless of the value of the 9th (alert) bit. The specified data byte applies to the least significant 8 bits (excludes the 9th (alert) bit).
- Similar choices are available for Tx.
- **Rx or Tx Parity Error** – Finds a parity error based on the parity you have set in the Bus Configuration Menu.
- **Rx or Tx Any Error** – Finds any error.

For more information on searching data, see ["Searching Lister Data"](#) on page 128.

For more information on using the **[Navigate]** key and controls, see ["Navigating the Time Base"](#) on page 60.

Index

Symbols

- (-) Width measurement, 230
- (+) Width measurement, 230

Numerics

- 1 M ohm input impedance, 67
- 50 ohm input impedance, 66

A

- About Oscilloscope, 309
- absolute value math function, 92
- AC channel coupling, 66
- AC RMS - Full Screen measurement, 225
- AC RMS - N Cycles measurement, 225
- accessories, 25, 334, 338, 339
- acquire, 187, 197
- Acquire key, 40
- acquisition memory, 144
- acquisition memory, saving, 279
- acquisition mode, 193
- acquisition mode, averaging, 197
- acquisition mode, high resolution, 199
- acquisition mode, normal, 194
- acquisition mode, peak detect, 194
- acquisition mode, preserve during
AutoScale, 304
- acquisition modes, 187
- active serial bus, 356, 364, 383, 393, 404, 429
- activity indicator, 111
- actual sample rate, 193
- adding digital channels license, 341
- addition math function, 77
- address with no ack condition, I2C
trigger, 379
- Addresses softkey, 298
- ADVMath license, 339
- AERO license, 339
- Agilent IO Libraries Suite, 322

- aliasing, 189
- aliasing, FFT, 88
- alternating edge trigger, 147
- AM (amplitude modulation), waveform
generator output, 268
- Amplitude measurement, 221
- amplitude modulation (AM), waveform
generator output, 268
- analog channel inputs, 41
- analog channel, probe attenuation, 69
- analog channel, setup, 63
- analog filters, adjusting, 83
- Analyze key, 37
- Analyze Segments, 200, 202, 240
- annotation, adding, 312
- arbitrary generated waveforms,
editing, 261
- arbitrary waveform generator output, 258
- arbitrary waveforms, copying from other
sources, 264
- arbitrary waveforms, creating new, 262
- arbitrary waveforms, editing existing, 263
- Area - Full Screen measurement, 236
- Area - N Cycles measurement, 236
- ARINC 429 serial decode, 417
- ARINC 429 totalizer, 420
- ARINC 429 trigger, 415
- ARINC 429 words/errors counter, 420
- ARINC 429 decode, signal speed, 414
- ARINC 429 decode, signal type, 415
- ARINC 429 decode, word format, 418
- ASCII file format, 274
- attenuation, probe, 69
- attenuation, probe, external trigger, 185
- attenuators, 71
- AUDIO license, 339
- Auto Increment, 283
- AUTO Option, 339
- Auto Scale key, 39
- Auto Setup, FFT, 84, 85
- Auto trigger mode, 180
- Auto? trigger indicator, 181

- AutoIP, 297, 298
- automatic measurements, 215, 217
- automatic setup, 109
- AutoProbe interface, 41, 66
- AutoScale preferences, 303
- AutoScale, digital channels, 109
- AutoScale, undo, 33
- Average - Full Screen measurement, 224
- Average - N Cycles measurement, 224
- average measurement trend, 97
- averaging acquire mode, 193, 197
- Ax + B math function, 90

B

- Back Up key, 36
- bandwidth, 309
- bandwidth limit, 67
- bandwidth required, oscilloscope, 192
- bandwidth, oscilloscope, 190
- base 10 exponential math function, 94
- Base measurement, 222
- BIN file format, 274
- binary data (.bin), 342
- binary data file examples, 346
- binary data in MATLAB, 343
- binary data, example program for
reading, 345
- bits, SPI trigger, 390
- Blackman Harris FFT window, 84
- blanking, 56
- BMP file format, 274
- brick-wall frequency response, 190
- brightness of waveforms, 36
- Browser Web Control, 317, 318, 319, 320, 321
- Browser-Based Remote Front Panel, 320
- built-in help, 47
- burst width measurements, 230
- burst, capture signal bursts, 199
- bus display mode, 114
- buttons (keys), front panel, 35

Index

BW Limit? in DVM display, 254

C

calibrate probe, 70
calibration, 306
calibration protect button, 44, 45
calibration status, 327
CAN decode, source channels, 352
CAN frame counter, 357
CAN serial decode, 355
CAN totalizer, 357
CAN trigger, 353
capture signal bursts, 199
cardiac waveform generator output, 260
Center, FFT, 83
channel labels, 137
channel, analog, 63
channel, bandwidth limit, 67
channel, coupling, 65
channel, invert, 68
channel, on/off keys, 41
channel, position, 65
channel, probe units, 69
channel, skew, 70
channel, vernier, 67
channel, vertical sensitivity, 65
characteristics, 331
chart logic bus state math function, 99
chart logic bus timing math function, 98
choosing values, 37
cleaning, 309
clear display, 196
clear display, Quick Clear Display, 311
clear persistence, 134
clock, 304
CMOS threshold, 113
common logarithm math function, 92
COMP license, 340
compensate passive probes, 34, 41
Config softkey, 297, 298
connect probes, digital, 105
connection, to a PC, 298
connectors, rear panel, 44
control, remote, 295
controls, front panel, 35
copyright, 2
Counter measurement, 229
counter, ARINC 429 words/errors, 420

counter, CAN frame, 357
counter, FlexRay frame, 373
counter, UART/RS232 frame, 430
coupling, channel, 65
coupling, trigger, 182
crosstalk problems, 83
CSV file format, 274
CSV files, minimum and maximum values, 349
current probes, 337
cursor measurements, 205
cursor units, 208
Cursors key, 40
Cursors knob, 40
cursors, binary, 207
cursors, hex, 207
cursors, manual, 206
cursors, track waveform, 207

D

D*, 39, 113
d/dt math function, 79
damage, shipping, 25
data sheet, 331
DC channel coupling, 66
DC offset correction for integrate waveform, 81
DC RMS - Full Screen measurement, 225
DC RMS - N Cycles measurement, 225
DC signals, checking, 181
DC waveform generator output, 259
dead time (re-arm), 202
decibels, FFT vertical units, 84
decimating samples, 193
decimation, for measurement record, 349
decimation, for screen, 349
default configuration, 31
default label library, 141
default setup, 31, 286
Default Setup key, 38
defaults, waveform generator, 272
delay knob, 51
Delay measurement, 218, 231
delay time indicator, 59
delayed sweep, 56
delete character, 283
delete file, 299
Demo 1 terminal, 41
Demo 2 terminal, 41
depth, AM modulation, 269
deviation, FM modulation, 270
DHCP, 297, 298
differential probes, 336
differentiate math function, 79
Digit softkey, 155
digital bus mode, 114
digital channel controls, 39
digital channel inputs, 42
digital channel menu, 112
digital channels, 112
digital channels, AutoScale, 109
digital channels, enabling, 341
digital channels, logic threshold, 112
digital channels, probing, 117
digital channels, size, 111
digital display, interpreting, 110
Digital key, 39
digital probes, 105, 117
digital probes, impedance, 117
digital voltmeter (DVM), 253
Display key, 40
display multiple acquisitions, 188
display, area, 46
display, interpreting, 45
display, persistence, 133
display, signal detail, 131
display, softkey labels, 47
display, status line, 46
displayed channels AutoScale, 303
distortion problems, 83
Divide math function, 77
DNS IP, 297
Duty cycle measurement, 230
duty cycle measurement trend, 98
DVM (digital voltmeter), 253
DVM license, 340
Dynamic DNS, 297

E

ECL threshold, 113
edge speeds, 192
edge then edge triggering, 148
edge triggering, 146
EDK license, 340
EEPROM data read, I2C trigger, 379
either edge trigger, 147

EMBD license, 340
 energy of a pulse, 80
 English user interface and Quick Help, 48
 Entry knob, 37
 Entry knob, push to select, 37
 erase, secure, 287
 event table, 126
 expand about, 65, 301
 expand about center, 302
 expand about ground, 301
 exponential fall waveform generator
 output, 260
 exponential math function, 93
 exponential rise waveform generator
 output, 259
 exporting waveform, 273
 EXT TRIG IN as Z-axis input, 56
 EXT TRIG IN connector, 45
 external memory device, 42
 external trigger, 184
 external trigger, input impedance, 185
 external trigger, probe attenuation, 185
 external trigger, probe units, 185

F

f(t), 75
 factory default settings, 286
 Fall time measurement, 231
 fall time measurement trend, 98
 falling edges count measurements, 235
 fast debug AutoScale, 303
 FFT aliasing, 88
 FFT DC value, 88
 FFT measurement hints, 86
 FFT measurements, 83
 FFT resolution, 87
 FFT spectral leakage, 89
 FFT units, 88
 FFT vertical units, 84
 FFT window, 84
 file explorer, 299
 file format, ASCII, 274
 file format, BIN, 274
 file format, BMP, 274
 file format, CSV, 274
 file format, PNG, 274
 File keys, 40
 file name, new, 283

file, save, recall, load, 299
 filter math function, high pass and low
 pass, 95
 filters, math, 94
 fine adjustment, horizontal scale, 58
 firmware updates, 341
 firmware upgrade files, 327
 firmware version information, 315
 firmware versions, 327
 flash drive, 42
 flat frequency response, 191
 Flat top FFT window, 84
 FLEX license, 340
 FlexRay frame counter, 373
 FlexRay serial decode, 371
 FlexRay totalizer, 373
 FlexRay trigger, 368
 FM (frequency modulation), waveform
 generator output, 269
 folding frequency, 189
 forcing a trigger, 145
 frame trigger, I2C, 380
 freeze display, 311
 freeze display, Quick Freeze Display, 311
 French front panel overlays, 43
 French user interface and Quick Help, 48
 frequency deviation, FM modulation, 270
 Frequency measurement, 228
 frequency measurement trend, 97
 frequency modulation (FM), waveform
 generator output, 269
 frequency requirements, power source, 29
 frequency, Nyquist, 189
 frequency-shift keying modulation (FSK),
 waveform generator output, 271
 front panel controls and connectors, 35
 front panel self test, 309
 front panel, browser-based remote, 320
 front panel, language overlay, 42
 front panel, real scope remote, 318
 front panel, simple remote, 319
 FSK (frequency-shift keying modulation),
 waveform generator output, 271

G

g(t), 75
 gateway IP, 297
 Gaussian frequency response, 190

gaussian pulse waveform generator
 output, 260
 Generic video trigger, 168
 German front panel overlays, 43
 German user interface and Quick Help, 48
 glitch capture, 195
 glitch trigger, 149
 golden waveform test, 241
 GPIB address, 296
 GPIB interface, remote control, 295
 GPIB module, 28, 44
 GPIB module installation, 28
 grabber, 107, 108
 graphical user interface language, 48
 graticule intensity, 135
 graticule type, 134
 grid intensity, 135
 grid type, 134
 ground level, 64
 Ground terminal, 41

H

Hanning FFT window, 84
 hardware self test, 308
 Help key, 40
 help, built-in, 47
 hex bus trigger, 155
 Hex softkey, 155
 HF Reject, 183
 high pass filter math function, 95
 high-frequency noise rejection, 183
 high-resolution mode, 193, 199
 holdoff, 184
 hop frequency, FSK modulation, 271
 Horiz key, 38, 49, 54, 56, 196
 Horizontal controls, 38, 53
 horizontal Navigate key, 38
 horizontal position control, 38
 horizontal position knob, 51
 horizontal scale fine adjustment, 58
 horizontal Search key, 38
 horizontal sweep speed control, 38
 horizontal time/div control, 38
 horizontal Zoom key, 38
 host name, 297, 315
 Host name softkey, 298

Index

I

I/O interface settings, 295
I2C serial decode, 382
I2C trigger, 378
I2S serial decode, 403
I2S trigger, 400
identification function, web interface, 326
idle serial bus, 356, 364, 383, 393, 404, 429
Imped softkey, 66
impedance, digital probes, 117
increment statistics, 240
indeterminate state, 207
infinite persistence, 133, 188, 195
information area, 46
input impedance, analog channel input, 66
installed licenses, 309
installed options, 326
instantaneous slope of a waveform, 79
Instrument Utilities web page, 326
Integrate math function, 80
intensity control, 131
Intensity key, 36
interpolate, arbitrary waveform option, 262
invert graticule colors, 276
invert waveform, 68
IP address, 297, 315
Italian front panel overlays, 43
Italian user interface and Quick Help, 48

J

Japanese front panel overlays, 43
Japanese user interface and Quick Help, 48

K

keyboard, USB, 140, 283, 292, 303, 313
keys, front panel, 35
knobs, front panel, 35
Korean front panel overlays, 43
Korean user interface and Quick Help, 48

L

Label key, 41

label list, 141
label list, loading from text file, 140
labels, 137
labels, auto-increment, 140
labels, default library, 141
LAN connection, 297
LAN interface, remote control, 295
LAN port, 44
LAN Settings softkey, 297, 298
LAN/VGA module, 28, 44
LAN/VGA module installation, 28
landscape mode, 292
language, user interface and Quick Help, 48
length control, 279
length softkey, 277, 278
level, trigger, 145
LF Reject, 182
library, labels, 139
licenses, 339, 341
LIN serial decode, 363
LIN trigger, 361
line voltage, 29
Lister, 126
load file, 299
Load from, 283
localized front panel overlay, 42
Location, 283, 300
logic presets, waveform generator, 266
logic threshold, 112
low pass filter math function, 95
low-frequency noise rejection, 182

M

magnify math function, 96
mask files, recall, 285
MASK license, 340
mask test, trigger output, 245, 305
mask testing, 241
mask, TRIG OUT signal, 305
math filters, 94
Math key, 39
math operators, 76
math transforms, 78
math visualizations, 96
math, 1*2, 77
math, 1/2, 77
math, addition, 77
math, differentiate, 79
math, divide, 77
math, FFT, 83
math, functions, 73
math, integrate, 80
math, multiply, 77
math, offset, 75
math, scale, 75
math, subtract, 77
math, transforms or filters on arithmetic operations, 75
math, units, 75, 76
math, using waveform math, 73
MATLAB binary data, 343
Maximum measurement, 221
maximum sample rate, 193
Meas key, 40, 215
Measure controls, 40
measure, Quick Measure All, 311
measurement category, definitions, 332
measurement definitions, 217
measurement record, 280
measurement statistics, 238
measurement thresholds, 236
measurement trend math function, 97
measurement window with zoom display, 238
measurements, 217
measurements, automatic, 215
measurements, delay, 218
measurements, overshoot, 218
measurements, phase, 219
measurements, preshoot, 219
measurements, time, 227
measurements, voltage, 220
MegaZoom IV, 4
mem4M, 340
memory depth and sample rate, 193
memory, segmented, 199
menu line, 46
MIL-STD-1553 serial decode, 410
MIL-STD-1553 trigger, 409
Minimum measurement, 221
missing acknowledge condition, I2C trigger, 379
Mode/Coupling key, trigger, 179
model number, 309, 315
Modify softkey, 298

modulation, waveform generator
 output, 267
 module installed, 309
 module slot, 44
 MSO, 4
 MSO feature upgrade, 341
 MSO license, 340
 Multicast DNS, 297
 multiplexed position knob, 39
 multiplexed scale knob, 39
 Multiply math function, 77

N

natural logarithm math function, 93
 navigate files, 299
 Navigate key, 38
 navigating the time base, 60
 negative pulse width measurement
 trend, 97
 network configuration parameters, 315
 network printer connection, 290
 network, connecting to, 297
 new label, 139
 noise rejection, 183
 noise waveform generator output, 259
 noise, adding to waveform generator
 output, 267
 noise, high-frequency, 183
 noise, low-frequency, 182
 noisy signals, 179
 non-volatile memory, secure erase, 287
 normal acquire mode, 194
 normal mode, 193, 194
 Normal trigger mode, 180
 notices, 2
 Nth edge burst trigger, 158
 Nth edge burst triggering, 158
 number of negative pulses
 measurements, 235
 number of positive pulses
 measurements, 234
 Nyquist frequency, 88
 Nyquist sampling theory, 189

O

offset (DC) correction for integrate
 waveform, 81

operators, math, 76
 options, print, 292
 OR trigger, 155
 oscilloscope bandwidth, 190
 oscilloscope bandwidth required, 192
 oscilloscope rise time, 191
 oscilloscope sample rate, 191
 output load expected, waveform
 generator, 265
 output, trigger, 304
 overlay, localized, 42
 Overshoot measurement, 218, 223
 overvoltage category, 333

P

palette, 276
 pan and zoom, 50
 parts, replacement, 122
 passive probes, 335
 passive probes, compensating, 34
 password (network), reset, 329
 password (network), setting, 327
 pattern trigger, 152
 pattern, SPI trigger, 390
 PC connection, 298
 peak detect mode, 193, 194, 195
 Peak-peak measurement, 221
 Period measurement, 228
 period measurement trend, 97
 persistence, 133
 persistence, clearing, 134
 persistence, infinite, 188
 Phase measurement, 219, 232
 phase X cursor units, 208
 PNG file format, 274
 point-to-point connection, 298
 pollution degree, 333
 pollution degree, definitions, 334
 Portuguese front panel overlays, 43
 Portuguese user interface and Quick
 Help, 48
 position digital channels, 113
 position knob, 113
 position, analog, 65
 positive pulse width measurement
 trend, 97
 post-processing, 215
 post-trigger information, 51

Power App measurements, 219
 power consumption, 29
 power cord connector, 44
 power requirements, 29
 power supply, 44
 power switch, 30, 36
 power-on, 29
 predefined labels, 138
 Preshoot measurement, 219, 224
 Press to go, 283, 300
 pre-trigger information, 51
 print, 311
 Print key, 40
 print options, 292
 print screen, 289
 print, landscape, 292
 print, Quick Print, 311
 printer, USB, 42, 289
 printing the display, 289
 probe attenuation, 69
 probe attenuation, external trigger, 185
 probe compensation, 41
 probe head, 71
 probe units, 69
 probe, AutoProbe interface, 41
 probe, calibrate, 70
 probes, 334, 338, 339
 probes, connecting to oscilloscope, 30
 probes, current, 337
 probes, differential, 336
 probes, digital, 105
 probes, passive, 335
 probes, passive, compensating, 34
 probes, single-ended active, 335
 programmer's guide, 323
 pulse polarity, 150
 pulse waveform generator output, 259
 pulse width trigger, 149
 PWR license, 340

Q

qualifier, pulse width, 151
 Quick Action key, 37, 311
 Quick Clear Display, 311
 Quick Freeze Display, 311
 Quick Help, 47
 Quick Help language, 48
 Quick Measure All, 311

Index

Quick Print, 311
Quick Recall, 311
Quick Save, 311
Quick Trigger Mode, 311

R

ramp waveform generator output, 259
random noise, 179
ratio measurement, 227
ratio measurement trend, 97
ratio X cursor units, 208
ratio Y cursor units, 208
raw acquisition record, 280
Real Scope Remote Front Panel, 318
rear panel connectors, 44
re-arm time, 202
recall, 311
recall files via web interface, 324
recall mask files, 285
recall setups, 284
recall, Quick Recall, 311
Rectangular FFT window, 84
Ref key, 39, 101
reference point, waveform, 301
reference waveforms, 101
remote control, 295
Remote Front Panel, 321
remote programming, Agilent IO Libraries, 322
remote programming, web interface, 321
replacement parts, 122
required oscilloscope bandwidth, 192
reset network password, 329
restart condition, I2C trigger, 379
return instrument for service, 310
Rise time measurement, 231
rise time measurement trend, 98
rise time, oscilloscope, 191
rise time, signal, 192
rise/fall time triggering, 157
rising edge count measurements, 235
RMS - AC measurement trend, 97
roll mode, 53
RS232 trigger, 425
Run Control keys, 38
runt pulses, 228
runt triggering, 160
Russian front panel overlays, 43

Russian user interface and Quick Help, 48

S

safety warning, 31
sample rate, 3
sample rate and memory depth, 193
sample rate, current rate displayed, 50
sample rate, oscilloscope, 190, 191
sampling theory, 189
sampling, overview, 189
save, 311
save file, 299
save files via web interface, 323
save segment, 277
save setup files, 275
save times, data, 280
Save to, 283
save, Quick Save, 311
save/recall from web interface, 323
Save/Recall key, 40
saver, screen, 302
saving data, 273
SCL, I2C trigger, 378
SCLK, I2S trigger, 398
SCPI Commands window, 321
screen image via web interface, 325
screen saver, 302
SDA, 377
SDA, I2C trigger, 378
Search key, 38
secure erase, 287
segmented memory, 199
segmented memory, re-arm time, 202
segmented memory, saving segments, 277
segmented memory, statistical data, 202
select digital channels, 113
select knob, 113
Selected, 300
selecting, values, 37
self test, front panel, 309
self test, hardware, 308
serial clock, I2C trigger, 378
serial clock, I2S trigger, 398
serial data, 377
serial data, I2C trigger, 378
serial decode controls, 39
Serial key, 39
serial number, 309, 315
service functions, 305
Set all Digits softkey, 155
setup and hold triggering, 162
setup files, saving, 275
setup, automatic, 109
setup, default, 31
setups, recall, 284
SGM, 199
SGM license, 340
shipping damage, 25
shipping precautions, 310
Sigma, minimum, 244
Simple Remote Front Panel, 319
Simplified Chinese front panel overlays, 43
Simplified Chinese user interface and Quick Help, 48
sinc waveform generator output, 259
sine waveform generator output, 259
single acquisition, 38
Single key, 187
single-ended active probes, 335
single-shot acquisitions, 181
single-shot events, 187
size, 111
skew, analog channel, 70
slope trigger, 146
Snapshot All measurements, 219
snapshot all, quick action, 311
softkey labels, 47
softkeys, 7, 36
software updates, 341
software version, 309
Span, FFT, 83
Spanish front panel overlays, 43
Spanish user interface and Quick Help, 48
specifications, 331
spectral leakage, FFT, 89
SPI serial decode, 391
SPI trigger, 389
square math function, 91
square root, 90
square waveform generator output, 259
square waves, 190
stand-alone connection, 298
start acquisition, 38
start condition, I2C, 379
state logic bus chart, 99
statistics, increment, 240
statistics, mask test, 246

statistics, measurement, 238
 statistics, using segmented memory, 202
 status line, 46
 status, User Cal, 309
 Std Deviation measurement, 225
 stop acquisition, 38
 stop condition, I2C, 379
 storage locations, navigate, 282
 subnet mask, 297
 subtract math function, 77
 sync pulse, waveform generator, 265

T

template, front panel, 42
 test, mask, 241
 theory, sampling, 189
 threshold, analog channel measurements, 236
 threshold, digital channels, 112
 thumb drive, 42
 tilt for viewing, 28
 time measurements, 227
 time reference indicator, 59
 time, re-arm, 202
 timebase, 53
 times for saving data, 280
 timing logic bus chart, 98
 Tools keys, 37
 Top measurement, 221
 totalizer, ARINC 429, 420
 totalizer, CAN, 357
 totalizer, FlexRay, 373
 totalizer, UART/rs232, 430
 tracking cursors, 207
 trademarks, 2
 Traditional Chinese front panel overlays, 43
 Traditional Chinese user interface and Quick Help, 48
 transforms, math, 78
 transient withstand capability, 333
 Transparent backgrounds, 302
 TRIG OUT connector, 45, 304
 Trig'd trigger indicator, 181
 Trig'd? trigger indicator, 181
 Trigger controls, 37
 trigger coupling, 182
 trigger indicator, Auto?, 181
 trigger indicator, Trig'd, 181

trigger indicator, Trig'd?, 181
 trigger level, 145
 trigger mode, auto or normal, 180
 trigger mode, Quick Trigger Mode, 311
 trigger output, 304
 trigger output, mask test, 245, 305
 trigger type, ARINC 429, 415
 trigger type, CAN, 353
 trigger type, edge, 146
 trigger type, edge then edge, 148
 trigger type, FlexRay, 368
 trigger type, glitch, 149
 trigger type, hex bus, 155
 trigger type, I2C, 378
 trigger type, I2S, 400
 trigger type, LIN, 361
 trigger type, MIL-STD-1553, 409
 trigger type, Nth edge burst, 158
 trigger type, OR, 155
 trigger type, pattern, 152
 trigger type, pulse width, 149
 trigger type, rise/fall time, 157
 trigger type, RS232, 425
 trigger type, runt, 160
 trigger type, setup and hold, 162
 trigger type, slope, 146
 trigger type, SPI, 389
 trigger type, UART, 425
 trigger type, USB, 175
 trigger type, video, 163
 trigger types, 143
 trigger, definition, 144
 trigger, external, 184
 trigger, forcing a, 145
 trigger, general information, 144
 trigger, holdoff, 184
 trigger, mode/coupling, 179
 trigger, source, 146
 triggers, TRIG OUT signal, 305
 TTL threshold, 113
 turn channel on, 41

U

UART totalizer, 430
 UART trigger, 425
 UART/RS232 frame counter, 430
 UART/RS232 license, 340
 UART/RS232 serial decode, 427

under-sampled signals, 189
 units, cursor, 208
 units, external trigger probe, 185
 units, math, 75, 76
 units, probe, 69
 updating software and firmware, 341
 upgrade files, 327
 upgrade options, 339
 upgrading the oscilloscope, 341
 upload new firmware, 315
 usb, 301
 USB device port, 45
 USB device port, remote control, 295
 USB host port, 45, 289
 USB host ports, 42
 USB printer, 289
 USB printers, supported, 289
 USB storage device, 42
 USB, CD device, 301
 USB, eject device, 42
 USB, storage device numbering, 301
 USB, trigger type, 175
 usb2, 301
 user cal, 306
 user calibration, 306
 user interface language, 48
 User-defined threshold, 113
 utilities, 295
 Utility key, 37

V

V RMS, FFT vertical units, 84
 values, choosing, 37
 variable persistence, 133
 ventilation requirements, 29
 vernier, channel, 67
 Vertical controls, 41
 vertical expansion, 65
 vertical position, 65
 vertical position knobs, 41
 vertical scale knobs, 41
 vertical sensitivity, 41, 65
 Vertical Units, FFT, 84
 VGA video output, 44
 VID license, 340
 video trigger, 163
 video trigger, custom Generic, 168
 viewing, tilt the instrument, 28

Index

VISA connect string, [315](#)
visualizations, math, [96](#)
voltage measurements, [220](#)
zoom display, measurement window
 with, [238](#)
Zoom key, [38](#)

W

warranted specifications, [331](#)
warranty, [310](#)
Wave Gen key, [37](#), [42](#)
waveform generator, [257](#)
waveform generator defaults,
 restoring, [272](#)
waveform generator expected output
 load, [265](#)
waveform generator logic presets, [266](#)
waveform generator sync pulse, [265](#)
waveform generator sync pulse, TRIG OUT
 signal, [305](#)
waveform generator, arbitrary
 waveforms, [261](#)
waveform generator, waveform type, [257](#)
Waveform keys, [40](#)
waveform type, waveform generator, [257](#)
waveform, cursor tracking, [207](#)
waveform, intensity, [131](#)
waveform, printing, [289](#)
waveform, reference point, [301](#)
waveform, saving/exporting, [273](#)
WAVEGEN license, [341](#)
web interface, [315](#)
web interface, accessing, [316](#)
white noise, adding to waveform generator
 output, [267](#)
Width - measurement, [230](#)
Width + measurement, [230](#)
Window, FFT, [84](#)

X

X at Max Y measurement, [234](#)
X at Max Y on FFT, [219](#)
X at Min Y measurement, [233](#)
X at Min Y on FFT, [219](#)
XY mode, [53](#), [54](#)

Z

Z-axis blanking, [56](#)
zoom and pan, [50](#)