

EASE Focus

Version 3



Developed by

AFMG® Ahnert Feistel Media Group

The creators of EASE®, EASERA, SysTune

www.afmg.eu

0. Table of Contents

| | |
|---|-----------|
| 1. Introduction to EASE Focus 3 | 4 |
| 1.1. Software Overview | 4 |
| 1.2. System Requirements | 5 |
| 1.3. How to Install | 5 |
| 1.4. User Interface..... | 7 |
| 1.5. Program Conventions..... | 9 |
| 1.6. Shortcut List..... | 12 |
| | |
| 2. Venue Definition, Line Arrays, and Loudspeakers | 14 |
| 2.1. Project Properties..... | 14 |
| 2.2. Top View..... | 15 |
| 2.3. Side View | 18 |
| 2.4. Adding Audience Zones..... | 19 |
| 2.5. Editing Audience Zones | 20 |
| 2.6. Copying Areas between Zones | 26 |
| 2.7. Saving Projects | 28 |
| 2.8. Loading Projects | 29 |
| 2.9. Importing and Managing System Definitions..... | 29 |
| 2.10. Adding Line Arrays..... | 31 |
| 2.11. Editing Line Arrays..... | 32 |
| 2.12. Auto Splay | 34 |
| 2.13. Overlap Regions | 36 |
| 2.14. Copying Setups between Similar Line Arrays | 36 |
| 2.15. Regular Loudspeakers, Steerable Columns | 39 |
| 2.16. Moving Active Sound Sources | 40 |
| 2.17. Snap to Loudspeaker and Stacking Loudspeakers | 41 |
| 2.18. Plug-Ins | 42 |
| 2.19. Secondary Properties Window..... | 43 |
| | |
| 3. Subwoofers | 44 |
| 3.1. Pre-Configured Subwoofer Arrays | 44 |
| 3.2. Manually Configured Arrays..... | 47 |
| | |
| 4. Mapping and Calculation Results..... | 50 |

| | | |
|-----------|--|-----------|
| 4.1. | Mapping Toolbar | 50 |
| 4.2. | Calculations Background | 51 |
| 4.3. | Mapping Options..... | 52 |
| 4.4. | Levels..... | 54 |
| 4.5. | Distribution Graph..... | 54 |
| 4.6. | Adding Receivers | 55 |
| 4.7. | Frequency Response | 56 |
| 4.8. | Sound Source Groups | 58 |
| 4.9. | Audience Area Groups | 60 |
| 4.10. | Exporting Pictures | 61 |
| 4.11. | Creating Reports..... | 62 |
| 5. | Options | 63 |
| 5.1. | View..... | 63 |
| 5.2. | Grid and Snap | 64 |
| 5.3. | Environment..... | 64 |
| 6. | Advanced Features..... | 66 |
| 6.1. | Setting Layout Pictures..... | 66 |
| 6.2. | Adding Section Planes | 68 |
| 6.3. | Mounting Height Based on the Lowest Point of System..... | 69 |
| 6.4. | Filter and Global Filter..... | 71 |
| 6.5. | Filter Settings for Line Arrays | 72 |
| 6.6. | Positive Cabinet Gain | 72 |
| 6.7. | Time Response | 73 |
| 6.8. | Coverage Optimization with AFMG FIRmaker | 74 |
| 6.9. | Exporting Line Array Configuration Data to EASE | 79 |
| 6.10. | Moving the Origin..... | 79 |
| 6.11. | Noise Settings..... | 81 |
| 7. | References | 82 |

1. Introduction to EASE Focus 3

1.1. Software Overview

EASE Focus 3 is a three-dimensional, acoustic simulation software for the configuration and modeling of line array systems and loudspeakers. The software is publicly available and it is free.

In EASE Focus, each line array or loudspeaker is described by a so-called system definition which contains the mechanical, electronic and acoustic properties of the loudspeaker system. This system definition is stored in an EASE GLL file which can be compiled with the EASE SpeakerLab software.

GLL data files are created and supplied by loudspeaker manufacturers. Any GLL file can be loaded into the EASE acoustic modeling software. However, in order to create a GLL that can be used in EASE Focus 3 a loudspeaker company needs to be licensed by AFMG.

Beginning with version 3.1, EASE Focus takes advantage of the newly developed plug-in architecture of the GLL to enhance the capabilities of GLL data files.

The EASE Focus 3 software program was developed over a period of several years and is related to EASE Focus 1 and Focus 2. EASE Focus 3 takes a large step forward towards realistic modeling of complex sound systems by including the following major features:

- 3D modeling of direct sound, displayed in horizontal and vertical cutting planes.
- Full support for EASE GLL files and data exchange with EASE and other AFMG software packages.
- Capability to use multiple line array systems in a single project.
- Virtual equalizer for tuning a line array in the simulation.
- Support for regular loudspeakers, subwoofer arrays, as well as for digitally steered columns and other more complex sound sources. An additional, proprietary DLL can be programmed in order to provide e.g. beam steering filters or a customized GUI.
- Full frequency range from 20 Hz to 20 kHz.
- High accuracy due to high internal data resolution and GLL data format. See AFMG white papers and AES articles for details.

Great efforts have been made to keep EASE Focus intuitive and easy-to-use while introducing three-dimensional coordinates and many new features. It can be considered a tool for both the end user, who needs to set up the sound system for a show, as well as for the R&D engineer, who is interested in the acoustic qualities of the array design. EASE Focus is the optimal tool for easy and quick prediction of the sound system performance in a given venue.

Compared to conventional aiming software the applicability of EASE Focus is much larger. It is not fixed to a single loudspeaker product. System definition files for different types of line arrays can be created and added to the software database at any time and without changing a single line of code.

EASE Focus 3 is one of the first of AFMG's software packages that incorporates FIRmaker technology. Using advanced numerical algorithms, AFMG FIRmaker allows calculating specific FIR filters for line arrays and column loudspeakers. These FIR filters are derived based on the layout of the venue and the design goals

specified by the user. Compared to conventional beam-steering FIRmaker optimization does not require any manual aiming.

EASE Focus is developed by Ahnert Feistel Media Group. Located in Berlin, Germany, AFMG is a worldwide leader in software for the pro-audio industry and has created the industry standards EASE and EASERA software for acoustic simulation and measurement as well as their related products EASE Focus, SysTune, EASE Address, EASE Evac and EASE SpeakerLab. AFMG works closely with leading university faculties, manufacturers and design clients to apply the latest developments in acoustical research and computer technology. For more information, including the latest news and forum posts, visit <http://afmg.eu>.

EASE and AFMG are registered trademarks of AFMG Technologies GmbH.

1.2. System Requirements

Minimum software requirements

- Microsoft Windows 7, 8, 8.1, or 10.
- Adobe Acrobat Reader 8.0 (or later).
- Microsoft .NET Framework v4.6.1, which can be downloaded here:

<https://www.microsoft.com/en-US/download/details.aspx?id=49982>

Minimum hardware requirements

- 2 GB RAM (4 GB or more recommended)
- 990 x 600 display resolution (1024 x 768 or higher recommended display resolution)
- 1.5 GHz processor speed or higher (multiple cores are supported and recommended)

For optimal program performance, it is recommended there is at least 30 GB of free disk space available.

1.3. How to Install

To install EASE Focus 3, unpack the ZIP file and double click on the executable named "setup". This will launch the setup utility that will install the program in a few easy steps. Note that for the installation you will need administrator rights on your computer.

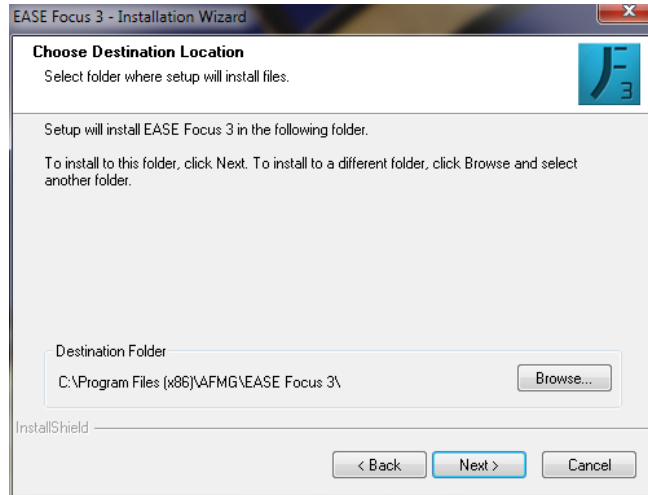

EASE Focus 3 can be installed on a computer that already has Focus 2 installed. By default it will be installed to a new location. While you can change the suggested target location, it is strongly recommended that you **do not** install Focus 3 in the same folder as Focus 2.

After the installation has completed successfully you can launch EASE Focus 3 using the desktop icon or the Windows Start menu. The software can be found in the AFMG folder. If you should experience problems with EASE Focus 3 at any time later, try starting the software with its default settings. This option is available as a command from the Windows Start menu.



Initial Setup of the Program

Upon start-up, the software will prompt you with the question if you would like to sign up for the AFMG newsletter in order to be informed about program updates and other AFMG news. We strongly recommend subscribing to the newsletter. You can do that by either pressing **YES** on the initial dialog window or by selecting the command **SIGN UP FOR NEWS** from the **HELP** menu. This will take you to the AFMG registration website where you can enter personal details as needed and make your choice about which news you would like to receive.

EASE Focus ships with a number of language options: English, German, French, Spanish, Italian, and Portuguese. Normally the first time EASE Focus is run it will detect the language of your operating system and use it automatically. If you wish to change the default language, press **F9** for the **OPTIONS** window and switch to the **ENVIRONMENT** page. Then select the desired language from the **LANGUAGE** drop-down list at the very top. (See §5.3)

The installation package of EASE Focus 3 includes a number of line array types and loudspeakers by default. But if you have new or updated system definition files, that is, GLL or DLL files, you may want to add them to your local database in order to make them available in EASE Focus 3. To do that press **Ctrl+I** or select **IMPORT SYSTEM DEFINITION File** from the **FILE** menu. A file dialog will open which allows you to select the GLL file of interest. Note that the program’s database manager will make a full copy of this GLL file in its database so you don’t have to worry that removing the GLL file from the original location after the import may cause problems. It will not. (See §2.9)

1.4. User Interface

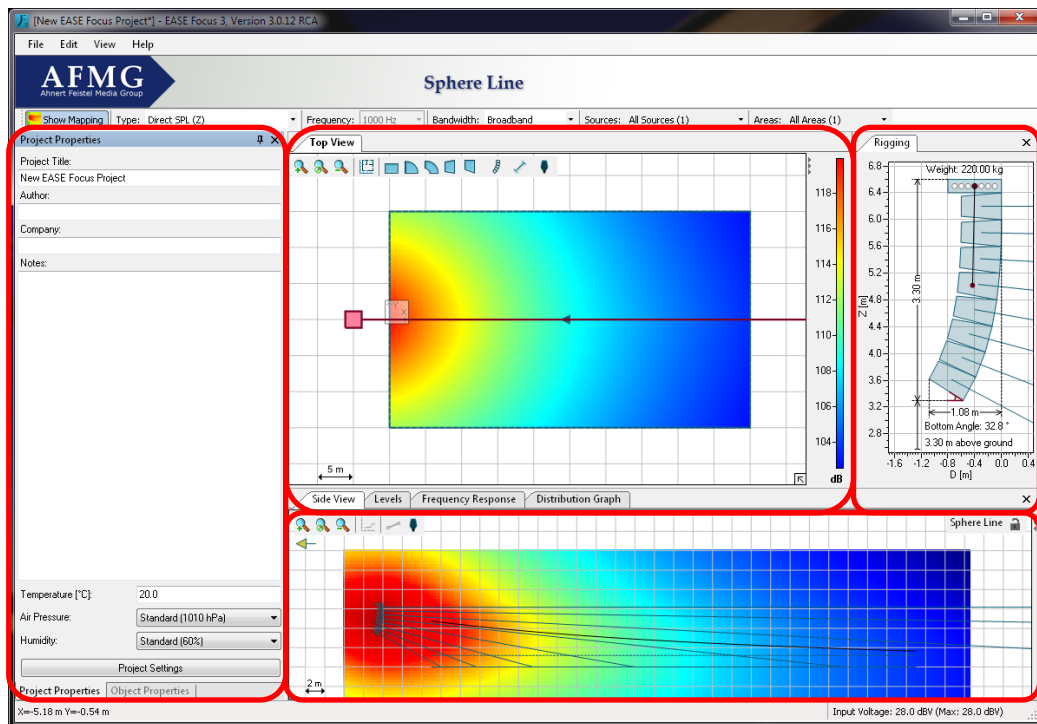

In EASE Focus, objects are generally added and selected in the Top View. Their properties can be viewed and modified in the Properties window as well as in the Side View. The Object Properties window displays the properties of the selected object or, if no object is selected, a list of the objects in the project. You can select an object directly from the list, and then see its properties with the `SHOW PROPERTIES` button, or go back to the list with the `SHOW OBJECT LIST` button.

The software GUI is subdivided into 4 screen areas:

- Left: Project Properties (§2.1) and Object Properties, used for editing Line Arrays (§2.11), Loudspeakers/Columns (§0), Pre-Configured Subwoofer Arrays (§3.1), Audience Zones (§2.5), Receivers (§4.6), and Section Planes (§6.2).
- Top: Top View (§2.2), horizontal coverage. This allows selecting, entering and modifying Audience Zones, Receivers, Line Arrays, Pre-Configured Subwoofer Arrays, Loudspeakers/Columns, and Section Planes in the X-Y-domain.
- Bottom: Side View (§2.3), vertical coverage. This allows entering and modifying Audience Areas for the selected Zone or changing the aiming and position of the selected Line Array system or other sound source. Additional tabs can be used to select Frequency Response (§4.7), Levels (§4.4) and Distribution (§4.5). In the Extended mode, Time Response (§6.7), source Filter and Global Filter (§6.3) are also available. For information on how to activate the Extended mode, see §5.3.
- Right: Rigging view. For some GLL files the Secondary Properties window will be shown here, as well (see §2.19).

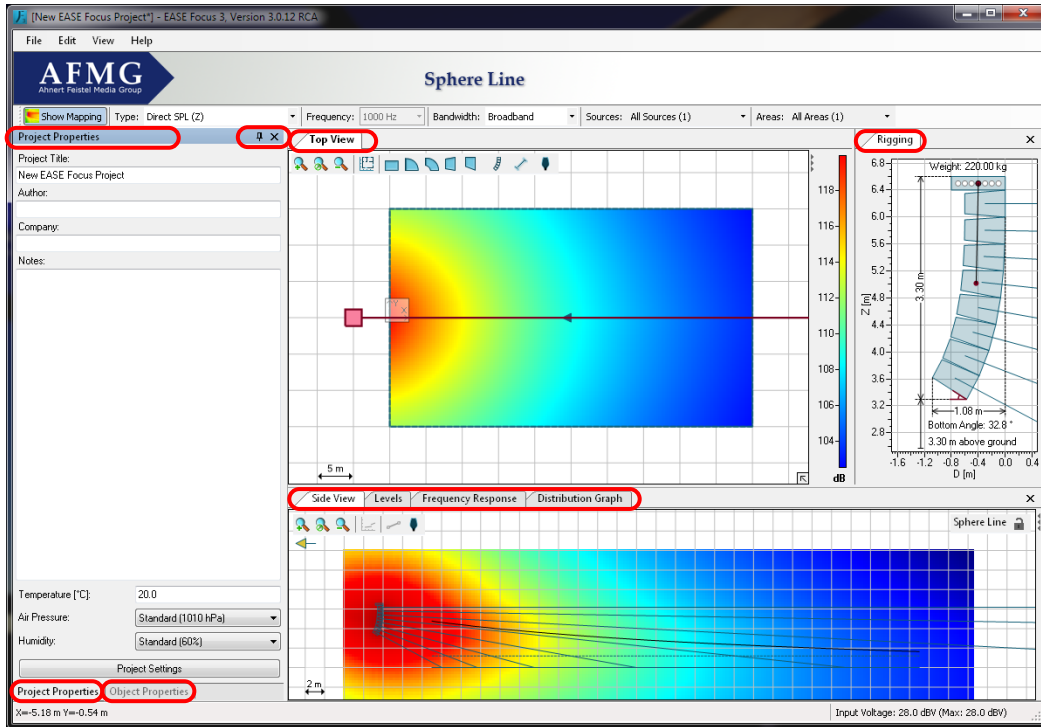

At the top of the main window you can find the menu bar, a panel displaying the manufacturer’s logo and the Mapping Toolbar (§4.1).

At the bottom is the status bar. On its left side readouts for mouse position are shown as you navigate maps and graphs of many windows in Focus (see §1.5 for more). On its right side you find the input voltage for the selected Sound Source (§4.2) as well as the status messages count relative to Sound Sources (§2.11) and Audience Zones (§2.5). Clicking on the message count or pressing F8 opens a window that lists them in detail.

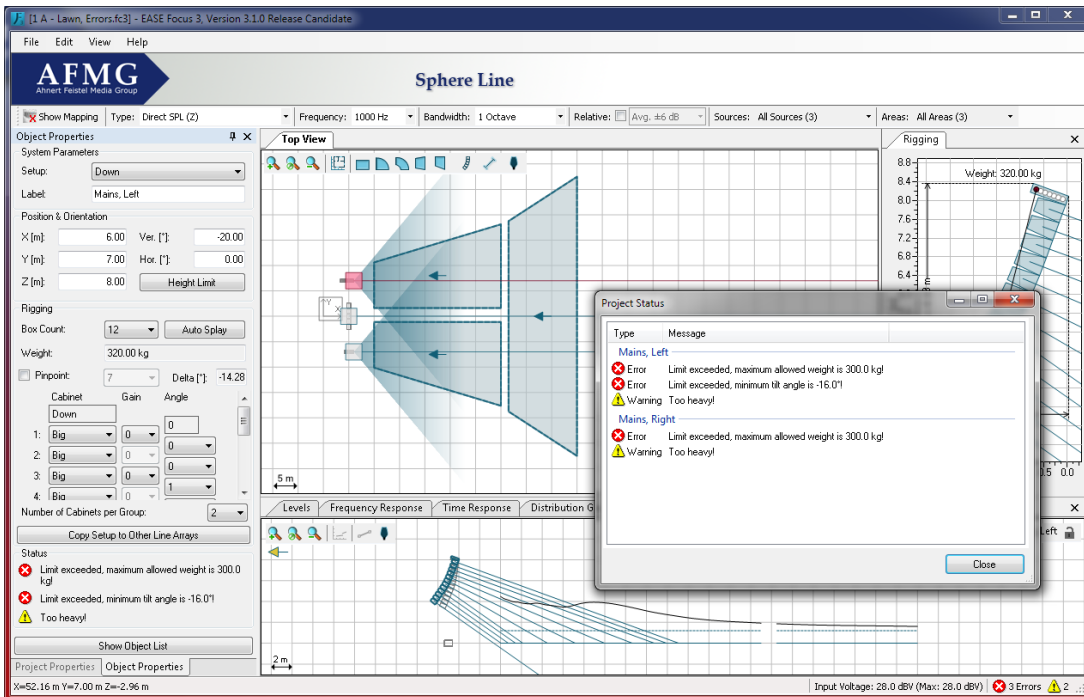

Note that you can move windows by grabbing their title bar or tab caption. You can also change their size relative to the other windows. Use the command `VIEW | RESET LAYOUT` to return to the original settings. Use the `STORE` and `RESTORE` commands in the `VIEW` menu to create and recall your own window layouts.

1.5. Program Conventions

Definition of Terms

There are four major types of objects in EASE Focus:

- **Audience Zones (§2.4):** Audience Zones are two-dimensional shapes roughly circumscribing the audience in one direction when looking from the stage. They contain one or more Audience Areas (§2.5). An Audience Area is always part of a Zone; it is defined by starting and ending points and is stretched out over the width of the Zone: this is the actual area where the audience is located.
- **Sound Source:** Based on the related system definition (GLL), a Sound Source consists of one or multiple point sources each of which is considered the origin of a sound wave. Technically, a Sound Source can be one of three types, a Line Array (§0), a Pre-Configured Subwoofer Array (§3.1), or a Loudspeaker/Column (§0). Depending on the properties of the Sound Source, the respective GUI elements may be different. Note that manually configured subwoofer arrays are constructed of individual loudspeaker-type Sound Sources.
- **Receiver (§4.6):** A Receiver is a representative point for detailed acoustic analysis, such as with respect to the local time or frequency response. This item has no acoustic relevance.
- **Section Plane:** A Section Plane is a user-defined, virtual surface that can be added to the project in order to view mapping data in an arbitrary vertical cutting plane (see §6.2). Like the Receiver, this item is purely virtual and has no effect on the computational results.

A Project is the set of all objects as defined before combined with the settings associated with the project such as regarding height limits or noise levels. Projects can be loaded from and saved to files with the extension `.fc3`. Project files from EASE Focus 2 (`.fc2`) can be loaded as well but they cannot be saved as `.fc2` files. They can be saved as `.fc3` files.

Coordinate System

The main coordinate system in EASE Focus uses XYZ coordinates. The origin marker is displayed by default in the Top View (but can be hidden, see §5.1) and can be moved to another location (§6.10). XYZ coordinates are used in the Object Properties window to indicate the position of all objects. The current mouse location in Top View, Side View and Rigging windows is shown in the status bar, along with the SPL value at that point, if an active Sound Source exists. For all other windows that display a plot you can also see current mouse coordinates in the status bar.

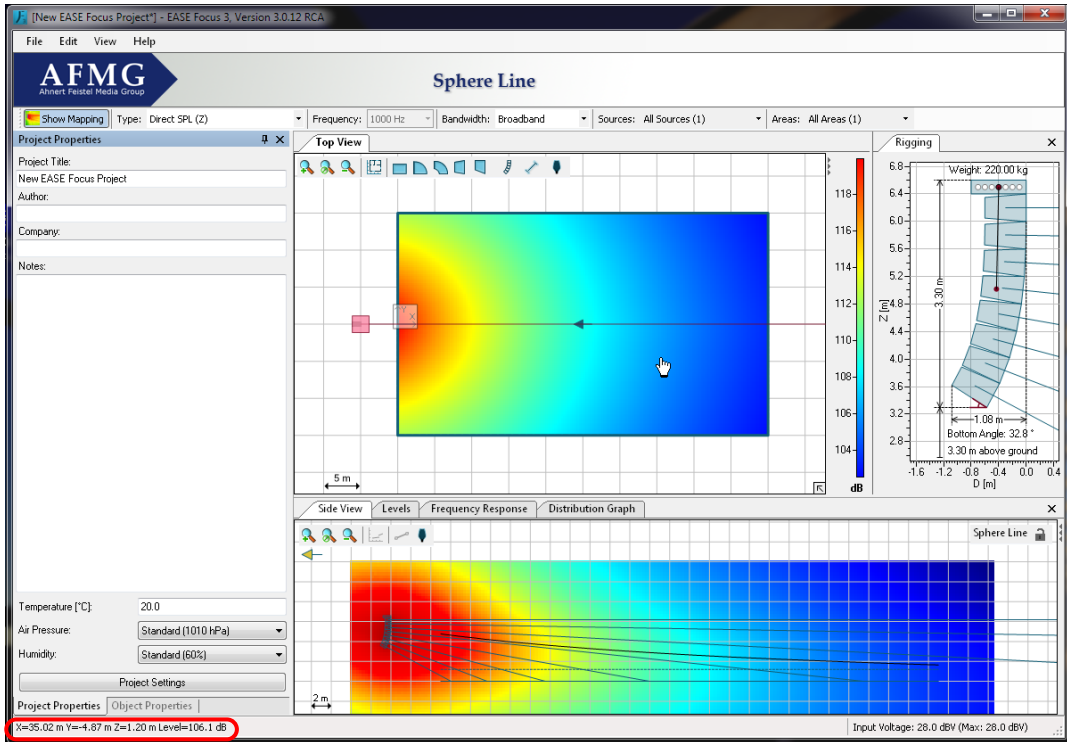

Another important coordinate system is DZ coordinates, used in Side View, Rigging and Levels windows. The DZ origin marker can be optionally hidden in Side View as well. While Z still refers to the elevation from the ground, D is relative to the position of the object whose section is displayed in Side View, and reflects the distance, along the object’s main axis, from its reference point: the location for Sound Sources (§0, §0, §3.1) and Receivers (§4.6), the front center point for Audience Zones (§2.4), or the starting point for Section Planes (§6.2). You can see how relative D values relate to XY coordinates in the status bar, while you move your mouse over Side View, Rigging and Levels windows.

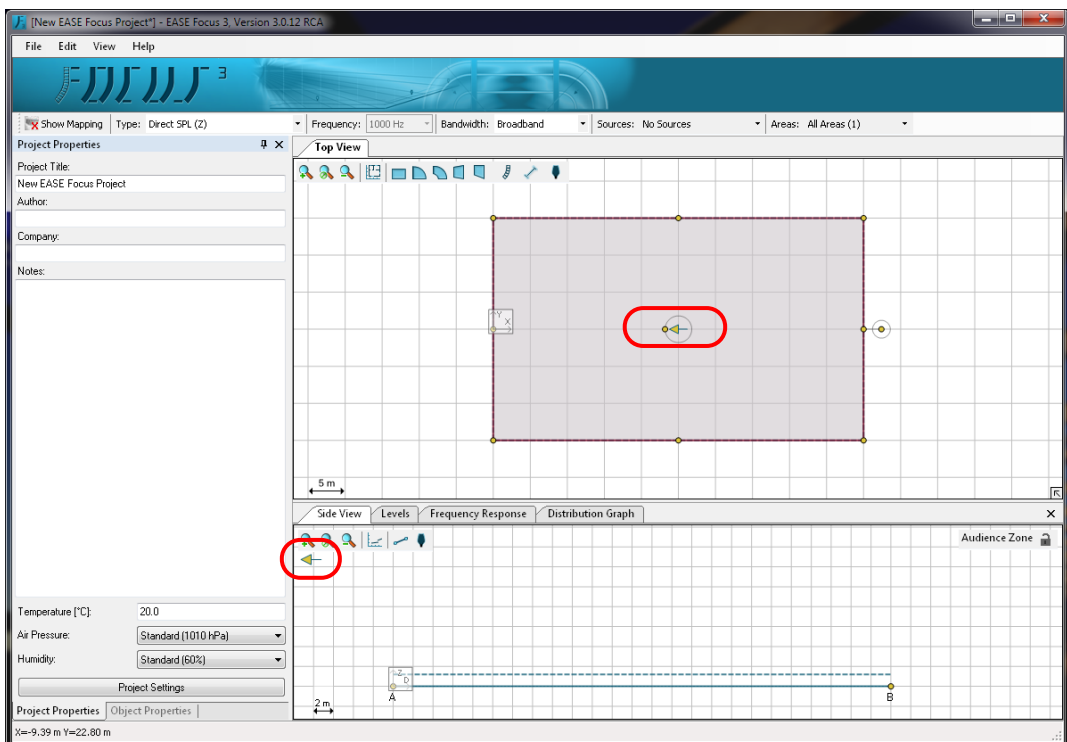

The difference between positive and negative D values is given by a simple convention of EASE Focus 3: in short, Sound Sources are expected to be radiating from left to right in Side View, and the audience is expected to face from right to left. For this reason, the Side View relative to Sound Sources is always showing them pointing right, while relative to Receivers, Audience Zones and Section Planes it shows them pointing left. If you have any doubt when using Audience Zones or Section Planes, refer to the yellow arrow appearing in the middle of those objects when they are selected, and pointing to their front center point (for Audience Zones) or starting point (for Section Planes): this is the same arrow that appears in the Side View, pointing left, and these two arrows are oriented in the same direction.

1.6. Shortcut List

Here is a list of all keyboard shortcuts available in EASE Focus, for quick reference.

Main window (always active):

| | |
|------------------------|--|
| F1 | Help; opens this User’s Guide |
| F4 | Show Object Properties or Object List |
| F8 | Show Project Status Messages (§1.4) |
| F9 | Options (see Chapter 5) |
| F10 | Scale to Fit (both Top View and Side View) |
| F11 | Select Previous Object |
| F12 | Select Next Object |
| Alt+F4 | Exit Focus |
| Ctrl+N | New Project |
| Ctrl+O | Open Project (§0) |
| Ctrl+S | Save Project (§2.7) |
| Ctrl+Shift+S | Save Project As (§2.7) |
| Ctrl+Z | Undo |
| Ctrl+Y | Redo |
| Ctrl+Alt+L | Add Sound Source (§0, §0) |
| Ctrl+I | Import System Definition (§2.9) |
| Ctrl+Alt+M | Manage System Definitions (§2.9) |
| Ctrl+M | Move Active Sound Sources (§2.16) |
| Ctrl+T | Change System (when a Sound Source is selected) |
| Ctrl+U | Move Selected Sound Source to Upper Height Limit (§6.3) |
| Ctrl+L | Move Selected Sound Source to Lower Height Limit (§6.3) |
| Ctrl+Shift+J | J-Array setup (when a Line Array is selected, see §2.11) |
| Ctrl+Shift+L | Lined setup (when a Line Array is selected, see §2.11) |
| Ctrl+Shift+U | Curved setup (when a Line Array is selected, see §2.11) |
| Ctrl+Shift+A | Auto Splay (when a Line Array is selected, see §2.12) |
| Ctrl+F1 ... F12 | Activate a stored layout: individual layout names and shortcuts can be seen in the View menu (§1.4) |
| Ctrl+Shift+R | Reset Layout |
| Ctrl+Alt+C | The automatic mapping color legend is by default optimized for Top View: use this shortcut to switch optimization between Top View and Side View |
| Shift+Alt+A | Transfer FIR Preset to Powersoft Armonia (only for supported system definitions) |
| Shift+Alt+L | Transfer FIR Preset to Lab.gruppen Lake Controller (only for supported system definitions) |

Top View (§2.2):

| | |
|---------------------|--|
| Ctrl+C | Copy selected object |
| Ctrl+V | Paste copied object |
| Ctrl+Shift+C | Copy Areas (for Audience Zones, see §2.6), Copy Setup (for Sound Sources, see §2.14) |
| Ctrl+Shift+V | Paste Areas (for Audience Zones, see §2.6), Paste Setup (for Sound Sources, see §2.14) |
| Del | Delete selected object |

Moving Active Sound Sources (§2.16):

| | |
|-------------------------|--|
| Ctrl + → | Move the sources along the positive X axis |
| Ctrl + ← | Move the sources along the negative X axis |
| Ctrl + ↑ | Move the sources along the positive Y axis |
| Ctrl + ↓ | Move the sources along the negative Y axis |
| Ctrl + Page Up | Move the sources along the positive Z axis |
| Ctrl + Page Down | Move the sources along the negative Z axis |
| Ctrl + + | Rotate the sources clockwise |
| Ctrl + - | Rotate the sources counterclockwise |

Modifier keys (to be held while performing a mouse action):

| | |
|--------------|---|
| Shift | Measure distance (when dragging between two points in Top View) |
| Alt | Ignore grid snapping in Top View (see §5.2 about snap settings). |
| Ctrl | Free the Receiver currently being edited (dragged), ignore auto-anchoring (§4.6), in Top View and Side View. Snap Sound Source currently being edited (dragged) to the ground or to the top of the Sound Source below it, in Top View (§2.17). |

2. Venue Definition, Line Arrays, and Loudspeakers

This section gives a brief introduction into the main features you need to know in order to model a small project with EASE Focus. We will explain how to enter a simple venue and then add line array systems to it. More advanced topics will be covered in the subsequent chapters.

The next chapters will guide you through the main steps of editing a project. Whenever you make a mistake, you can revert any modification to the project, or recover a reverted modification, with the menu items `EDIT | UNDO (Ctrl+Z)` and `EDIT | REDO (Ctrl+Y)`.

In this chapter and in the following ones you will find some yellow frames along the way, just like this one. These contain simple examples to help you learn how to use EASE Focus. You can choose to create your own project, or to work on this tutorial project and learn as you progress.

2.1. Project Properties

The Project Properties window is located on the left side of the main window. It contains basic information about the project (title, company, author, notes) as well as some settings that are relevant for calculations (temperature, air pressure, humidity).

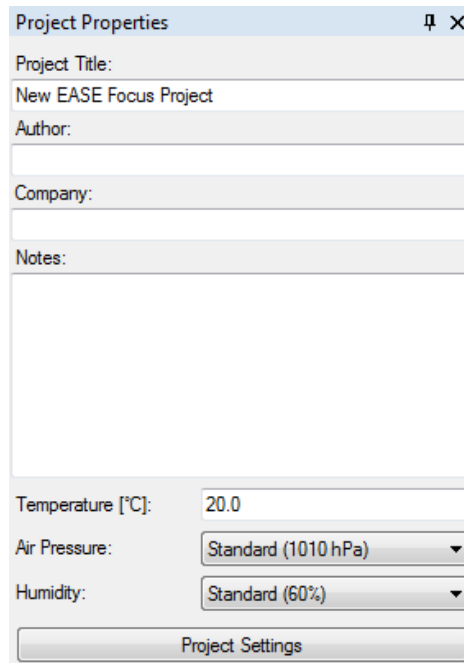

Project Properties

Project Title:
New EASE Focus Project

Author:

Company:

Notes:

Temperature [°C]: 20.0

Air Pressure: Standard (1010 hPa)

Humidity: Standard (60%)

Project Settings

From here you can also access the `PROJECT SETTINGS` window, where you can edit ear height values for Audience Areas. Three values are available: `SITTING`, `STANDING` and `CUSTOM`. When editing Audience Zones, you will be able to choose one of these values for each Area (§2.5). In the `PROJECT SETTINGS` window you

can also define default project-wide height limits for Sound Sources. When editing a Source you can choose whether to apply project limits or to define individual limits (§2.11).



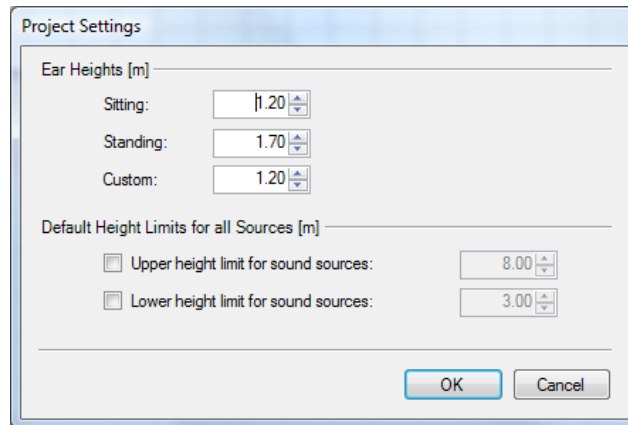









When working in Extended mode, you can access the NOISE SETTINGS from a button within the Project Properties window as well (§6.11). See §5.3 to learn how to activate Extended mode.



2.2. Top View

The Top View displays a plan of the venue, and contains all objects in the project: Audience Zones, Sound Sources, Receivers, and Section Planes. To select an object, click on it with the left mouse button; to move it, just drag it around the window. In addition, objects have either aiming lines (Sound Sources and Receivers) or yellow handles (Audience Zones, Section Planes) to rotate them and resize them with a simple mouse drag.

The Top View toolbar is located on the top left corner of this window. It includes the following buttons:

-  Zoom in
-  Fit the zoom to the project
-  Zoom out
-  Add Layout Picture (§6.1)
-  Add Audience Zone (Rectangle) (§2.4)
-  Add Audience Zone (Circular Sector) (§2.4)
-  Add Audience Zone (Annular Sector) (§2.4)
-  Add Audience Zone (Trapezoid) (§2.4)
-  Add Audience Zone (Right-Angled Trapezoid) (§2.4)
-  Add Sound Source (§0, §0)
-  Add Section Plane (§6.2)
-  Add Receiver (§4.6)

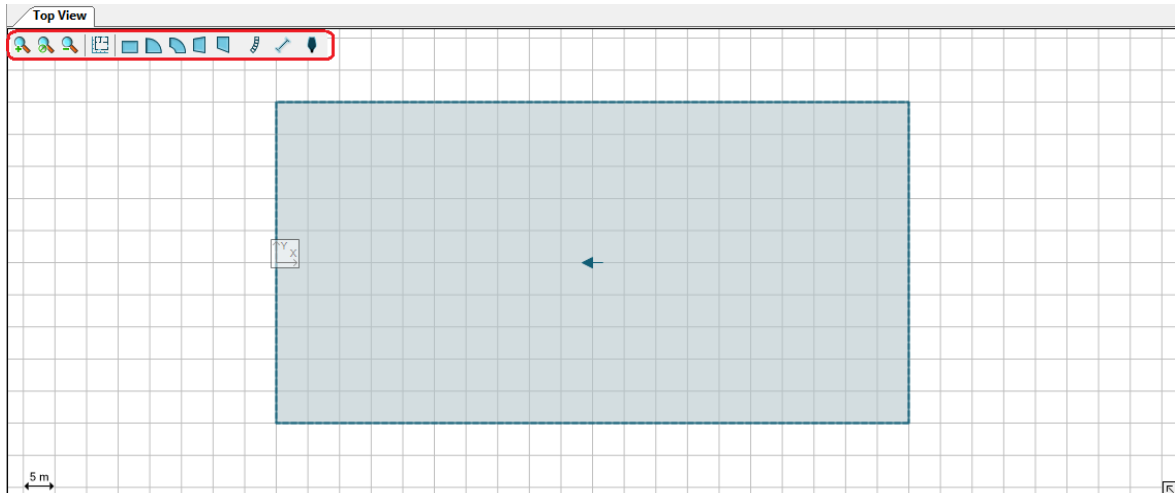

To add an object, first click on the button in the toolbar corresponding to the desired object. Then move the mouse to the desired location in the drawing, click the left button and drag with your mouse until you are satisfied with the size and orientation of the object. If you click without dragging, the object will be centered on mouse location and take on the default size and orientation, which you can then modify later.

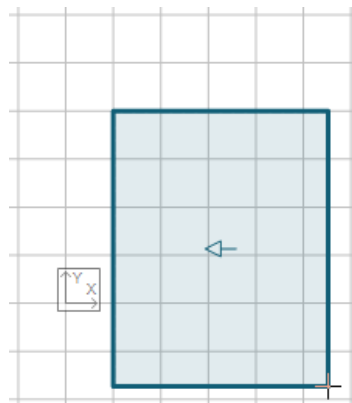

Clicking anywhere in the Top View with the right mouse button will open the context menu, where you can perform any of the following actions:

- **ADD AUDIENCE ZONE:** inserts a new Audience Zone into the Project (RECTANGLE, CIRCULAR SECTOR, ANNULAR SECTOR, TRAPEZOID, RIGHT-ANGLED TRAPEZOID), as an alternative method to the toolbar buttons (§2.4).
- **ADD SOUND SOURCE:** inserts a Line Array (§0), Pre-Configured Subwoofer Array (§3.1), or a Loudspeaker/Column (§0) into the Project, as an alternative method to toolbar buttons.
- **COPY (Ctrl+C):** copies the selected object to the clipboard.
- **PASTE (Ctrl+V):** pastes any previously copied object into the Project.
- **DELETE (Del):** removes the selected object.
- **COPY AREAS (Ctrl+Shift+C):** when an Audience Zone is selected, stores its Audience Areas to be subsequently applied to another Audience Zone (§2.6).
- **PASTE AREAS (Ctrl+Shift+V):** when an Audience Zone is selected, and Audience Areas have been copied from another Zone, pastes them to the selected Zone (§2.6).
- **COPY SETUP (Ctrl+Shift+C):** when a Sound Source is selected, stores its setup to be subsequently applied to a compatible Source (§2.14).
- **PASTE SETUP (Ctrl+Shift+V):** when a Sound Source is selected, and a setup has been copied from a compatible Source, applies it to the selected Source (§2.14).

- **PASTE SETUP WITH OPTIONS:** when a Sound Source is selected, and a setup has been copied from a compatible Source, opens a dialog window for selecting additional paste options in order to copy only selected properties to the target Source (§2.14).

Please note that copying objects, copying Audience Areas, and copying Sound Source setups are three independent functions that do not override or affect each other. However, copying objects and copying pictures (see below) both use the Windows clipboard, and will override each other.

- **EDIT:** performs an action affecting the selected object. You can **FLIP HORIZONTALLY**, **FLIP VERTICALLY**, **ROTATE CLOCKWISE**, **ROTATE COUNTERCLOCKWISE**.
- **SAVE PICTURE TO:** saves the content of the Top View as an image file (§4.10).
- **COPY PICTURE TO CLIPBOARD:** copies the content of the Top View as an image in the Windows clipboard, to be pasted into any Windows application that supports it.
- **MOVE ORIGIN HERE:** specifies a new origin for the Project coordinates (§6.10).
- **PROPERTIES (F4):** when an object is selected, shows the Object Properties window for that object if it is hidden and brings it to the top.
- **OBJECT LIST (F4):** when no object is selected, shows the object list if it is hidden and brings it to the top.

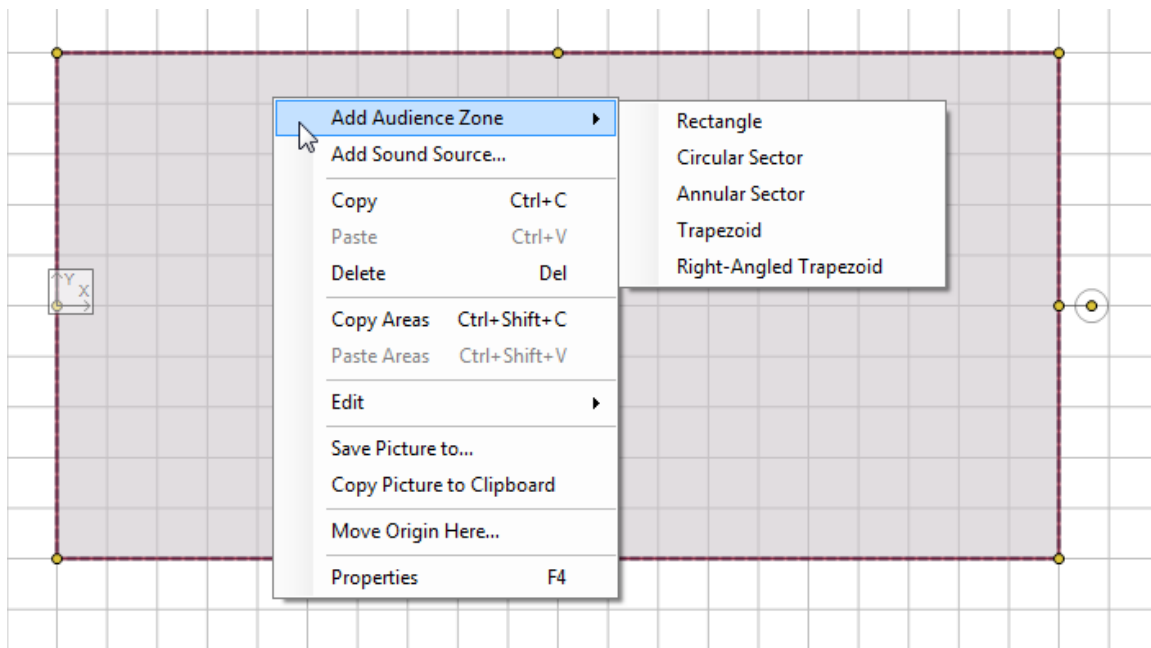

Note that all drawing and editing options snap by default to the displayed grid; this can be changed in the options (§5.2). Holding the Alt key will also temporarily deactivate the snap to the grid. Holding the Shift key before dragging with the mouse will measure any distance in length and time delay.

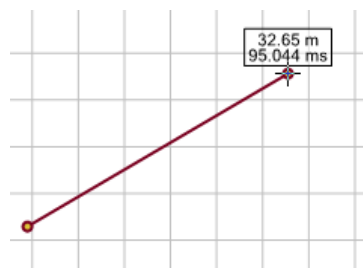

On the bottom right corner you can see a miniature map of the whole project, displaying the portion currently being viewed: this small frame can be collapsed if you don’t need it. To the left of it, a Mapping

Progress Bar will appear whenever mapping data are being calculated. The Mapping Legend appears by default on the right edge of the Top View whenever color mapping is active and visible, but it can also be collapsed by clicking on the three small triangles in the upper left of its window.

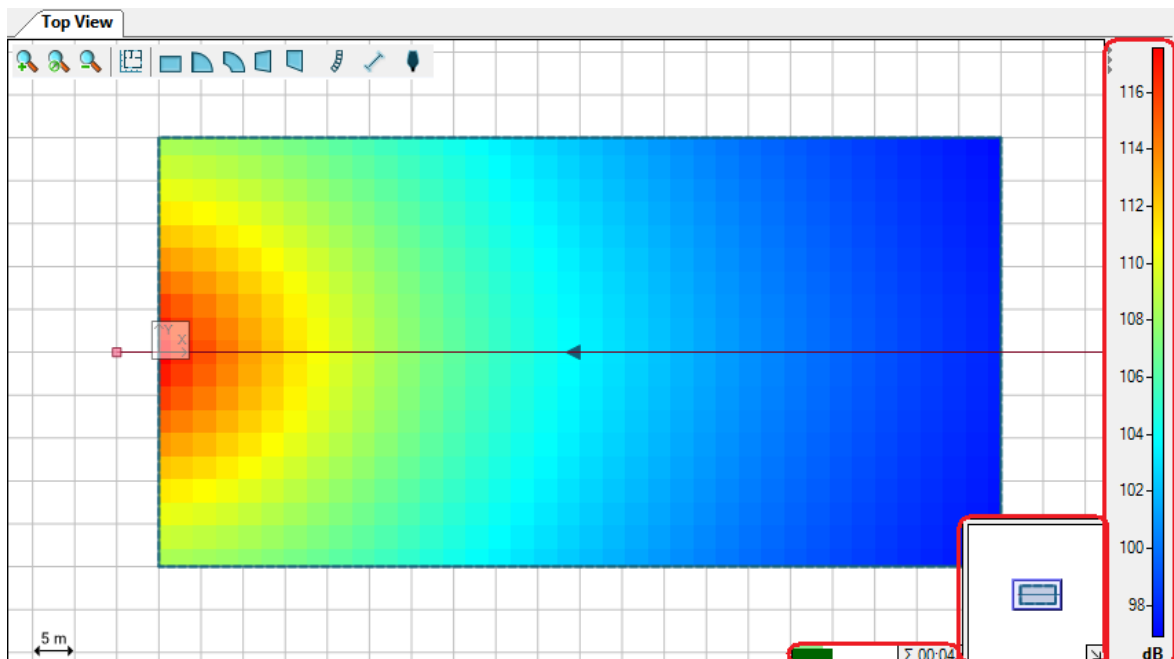

2.3. Side View





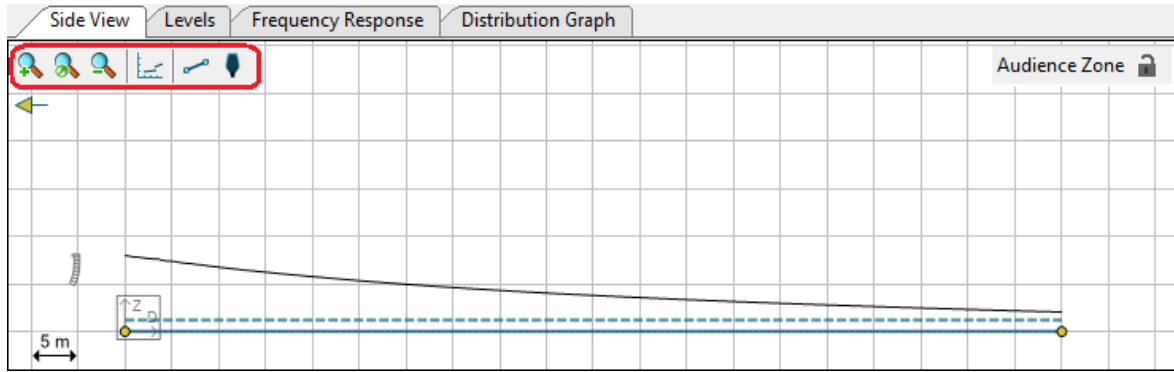

The Side View has an interface similar to the Top View, except it will not show the whole project, but only a vertical section of it, referring in general to the selected object. The section is taken along the central axis of the object: for Audience Zones this is the line going through the orientation arrow displayed in the Top View, for Sound Sources and Receivers it is the aiming line, and for Section Planes the plane itself.

To understand in which direction you are looking when an Audience Zone or a Section Plane is selected, use the yellow arrow in the top left corner: it replicates the arrow appearing on these two types of objects when they are selected, and points in the same direction. When a Sound Source is selected, the Side View displays it to the left, with the aiming line oriented rightwards; the aiming line points leftwards instead, in the case of Receivers.

You can also see the related Side View of an object which is not selected. Use the Lock symbol  in the upper right corner of the Side View window to keep the side view of an object while manipulating another one. This is helpful, for example, when you want to adjust the location of a Receiver in the Side View of a Line Array or change the splay angles of a Line Array while viewing an audience zone.



Just like the Top View, the Side View has its toolbar in the top left corner as well. It displays these buttons:

-  Zoom in
-  Fit the zoom to the project
-  Zoom out
-  Add Layout Picture (when an Audience Zone or a Section Plane is being displayed) (§6.1)
-  Add Audience Area (when an Audience Zone is being displayed) (§2.5)
-  Add Receiver (§4.6)

A Mapping Progress Bar will appear in the bottom right corner whenever mapping data are being calculated.

The Side View window is particularly useful to edit Audience Zones (§2.6), Line Arrays (§2.11), Pre-Configured Subwoofer Arrays (§3.1), and Loudspeakers/Columns (§0) with a graphical interface.

2.4. Adding Audience Zones

Audience locations are defined on two levels. First, Audience Zones are entered in the Top View and should include all particular seating areas in one direction looking towards the center or stage of the venue. In a second step, a profile consisting of one or multiple Audience Areas is defined for each Zone.

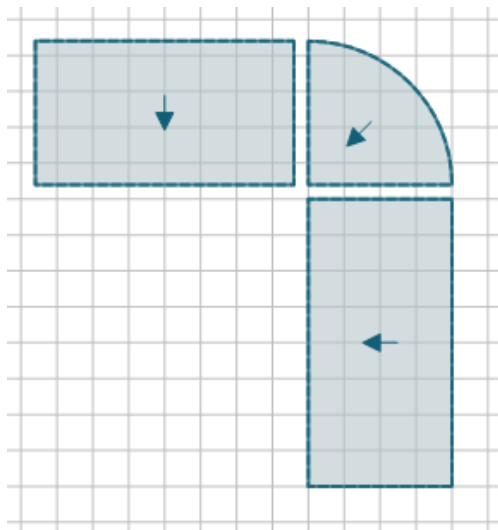

A Zone is basically a simple 2D shape that can be understood as the circumjacent projection of the seating areas in one part of the venue on the horizontal plane. It is defined by a location, orientation, and properties specific to the shape, such as the width and depth of a rectangle.

Use the shape icons in the top view to select a particular shape for insertion:



Then add an Audience Zone by clicking or dragging.

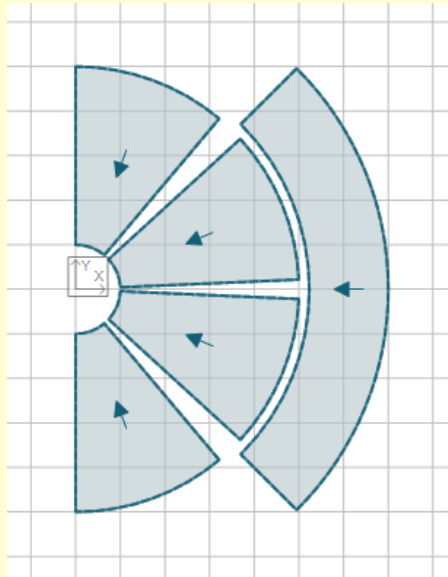

Draw an amphitheater similar to the one shown above. You will need five Annular Sectors. Give them meaningful names like “Floor Left”, “Floor Middle Left”, “Floor Middle Right”, “Floor Right”, “Balcony”.

2.5. Editing Audience Zones

Select a Zone by simple left-click.

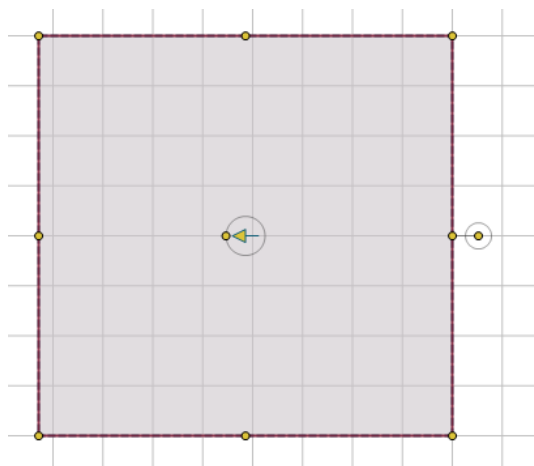

When active, the Zone will be highlighted in dark red. It will also show yellow handles that allow you to resize, rotate or change the shape of the Zone. A Zone can be moved relative to other objects by simply left-dragging it with the mouse. The yellow arrow (blue when the Zone is deselected) indicates the viewing direction of the spectators.

An Audience Area is always part of a Zone and is defined by a starting point and an ending point relative to the Zone. There can be multiple Areas inside a Zone. In 3D, these Areas are assumed to be stretched out over the width of the entire Zone, depending on the symmetry of the shape.

Selecting a Zone will show the Zone’s profile in the side view.

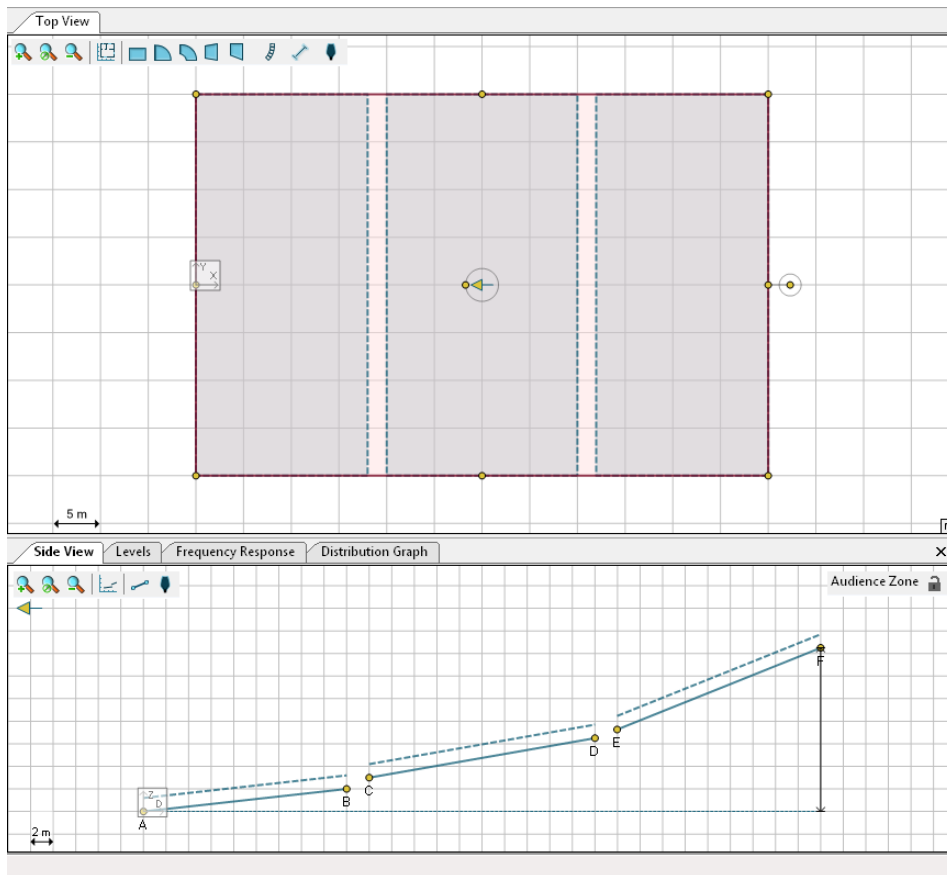

Use the line icon  to enter a new Area for this Zone. Note that you can also left-drag the yellow handles at the ends of an Area to resize it or left-drag the center of an Area to move it. Left-drag the white background of the drawing to move the objects relative to the screen.

The horizontal dotted line at the bottom of the Side View indicates the Audience Zone. The Audience Zone above consists of three Audience Areas denoted by the solid lines with the yellow handles. The dotted lines that are parallel to the Audience Areas indicate the selected listening heights.

Object Properties

Label: Audience Zone

Orientation [°]: 0.00

Depth [m]: 60.00

Width [m]: 40.00

⊕ Front Center: X [m] 0.00 Y [m] 0.00

Add Area Copy Areas...

Audience area: Audience Area 1

Audience Area 1 Remove

| | D [m] | Z [m] | Length [m] | Angle [°] |
|---|-------|-------|------------|-----------|
| A | 0.00 | 0.00 | 18.11 | 6.34 |
| B | 18.00 | 2.00 | | |

Ear height: Sitting

Audience area: Audience Area 2

Audience Area 2 Remove

| | D [m] | Z [m] | Length [m] | Angle [°] |
|---|-------|-------|------------|-----------|
| C | 20.00 | 3.00 | 20.30 | 9.93 |
| D | 40.00 | 6.50 | | |

Ear height: Sitting

Audience area: Audience Area 3

Audience Area 3 Remove

| | D [m] | Z [m] | Length [m] | Angle [°] |
|---|-------|-------|------------|-----------|
| E | 41.96 | 7.27 | 19.43 | 21.86 |
| F | 60.00 | 14.50 | | |

Ear height: Sitting

Edit relative to reference point at D=0

Show Object List

Project Properties Object Properties

Properties of Audience Zones can also be modified from the Object Properties window. Below is a short description of all Audience Zone types and of the attributes available for each one.

Rectangle: a rectangular Zone, with the audience facing one of the edges

- **ORIENTATION:** the direction the Audience Zone is facing (0° = facing left)
- **DEPTH:** the size of the Zone along its axis
- **WIDTH:** the size of the Zone across its sides
- **FRONT CENTER, FRONT LEFT, FRONT RIGHT, BACK LEFT, BACK RIGHT:** position of the main reference points

Circular Sector: a Zone whose shape is a circular sector (like a piece of pie), with the audience facing the corner point

- **ORIENTATION:** the direction the Audience Zone is facing (0° = facing left)
- **DEPTH:** the size of the Zone along its axis
- **SWEEP ANGLE:** the angular width of the sector
- **FRONT CENTER, BACK LEFT, BACK RIGHT:** position of the main reference points

Annular Sector: a Zone whose shape is an annular sector (a portion of a ring), with the audience facing the center of the circle

- **ORIENTATION:** the direction the Audience Zone is facing (0° = facing left)
- **DEPTH:** the size of the Zone along its axis

- **INNER RADIUS:** distance between the inner circle and the center of the circle (outer radius = inner radius + depth)
- **SWEEP ANGLE:** the angular width of the sector
- **FRONT CENTER, FRONT LEFT, FRONT RIGHT, BACK LEFT, BACK RIGHT:** position of the main reference points

Trapezoid: a Zone whose shape is an isosceles trapezoid, with the audience facing one of the parallel edges

- **ORIENTATION:** the direction the Audience Zone is facing (0° = facing left)
- **DEPTH:** the size of the Zone along its axis
- **FRONT WIDTH:** the size of the parallel edge faced by the audience
- **BACK WIDTH:** the size of the parallel edge behind the audience
- **FRONT CENTER, FRONT LEFT, FRONT RIGHT, BACK LEFT, BACK RIGHT:** position of the main reference points

Right-Angled Trapezoid: a Zone whose shape is a right-angled trapezoid, with the audience facing one of the parallel edges

- **ORIENTATION:** the direction the Audience Zone is facing (0° = facing left)
- **DEPTH:** the size of the Zone along its axis
- **FRONT WIDTH:** the size of the parallel edge faced by the audience
- **BACK WIDTH:** the size of the parallel edge behind the audience
- **ORTHOGONAL SIDE:** specifies which of the two non-parallel edges is orthogonal with respect to the parallel edges (left or right, with respect to the audience)
- **FRONT CENTER, FRONT LEFT, FRONT RIGHT, BACK LEFT, BACK RIGHT:** position of the main reference points

Audience Areas can even be added or removed from the Object Properties window, and their profile can be copied to other Zones (§2.6).

When editing an Audience Area note that in the Side View the points that defines each of the Audience Areas within an Audience Zone are uniquely labeled (i.e. A, B, C...) to make identification quick and accurate. The location of each of these points is specified by entering its distance and height from the DZ coordinate origin. These are entered in the $D [M]$ and $Z [M]$ boxes, respectively.

For every Audience Area you can set the following attributes:

- **D:** the distance from the front of the Zone to the location of the selected point
- **Z:** the height from the floor to the location of the selected point
- **EAR HEIGHT:** ear height of the audience, selected from three pre-defined values (see §2.1)

An Audience Area also has settings for **LENGTH** and **ANGLE**. When editing in zone coordinates these denote the length of the Audience Area along its axis (diagonally, taking into account the differences in height from the front to the rear of the area) and the angle of the Audience Area with respect to the horizontal plane. Entering values for **LENGTH** and **ANGLE** will alter the values of **D** and **Z** for the end point of the Audience Area, and vice-versa.

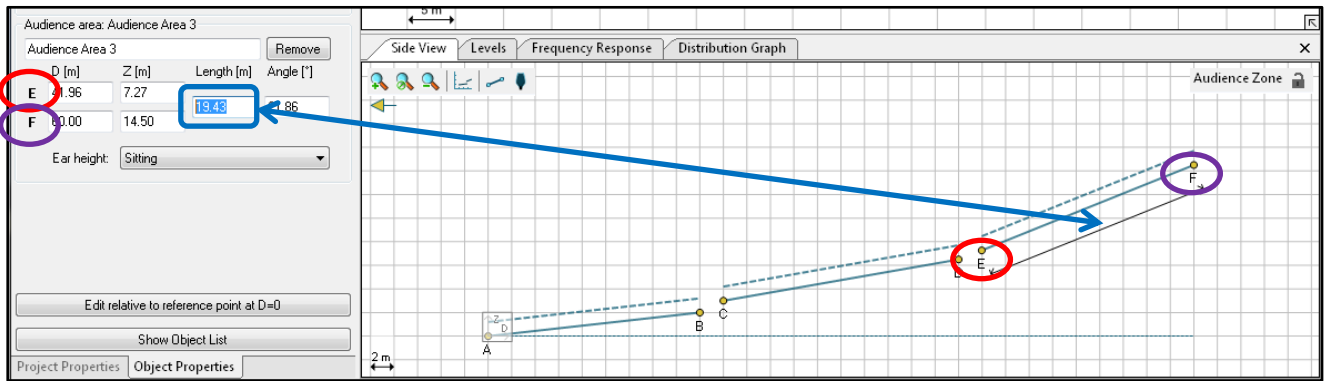

It is also possible to enter the locations of the front and rear points for an Audience Area in polar coordinates. Clicking the `EDIT RELATIVE TO REFERENCE POINT AT D=0` button at the bottom of the Audience Area properties enables the use of polar coordinate entry. In this mode a reference point, R, is shown in the Side View. The height of this reference point can be made whatever is convenient for the user. The reference point is always at distance of $D=0$. The length and angle from this reference point to the front and rear points that define each audience area can now be entered directly.

This polar coordinate entry method makes it very easy to use a laser range finder at a fixed location in a venue and “shoot” the front and rear points of each audience area to find the distance and angle from the reference point to each of these audience points. Note, however, that you will need to choose the origin of the Audience Zone so that it matches your measurement position relative to the venue.

When one of the data boxes is selected (by clicking in it) a line from the reference point to the selected point defining the Audience Area will be shown in the Side View to graphically indicate the item selected.

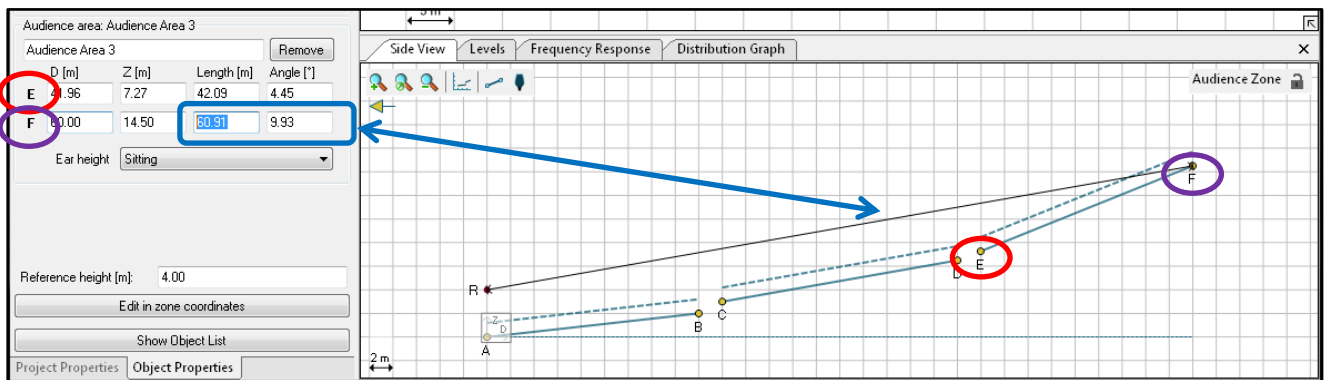

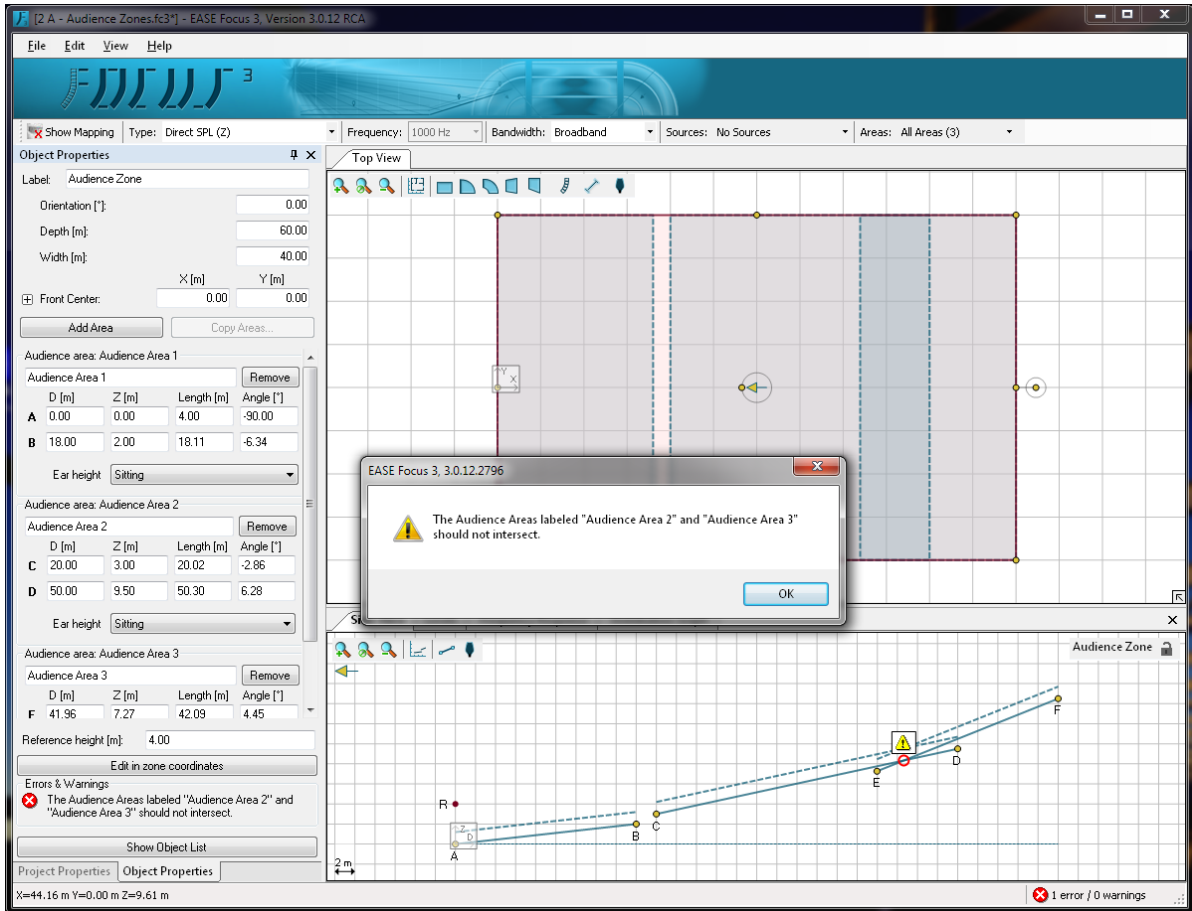

If two Audience Areas intersect, error messages will be shown, both in the Audience Zone related Object Properties and Side View and in the status bar.

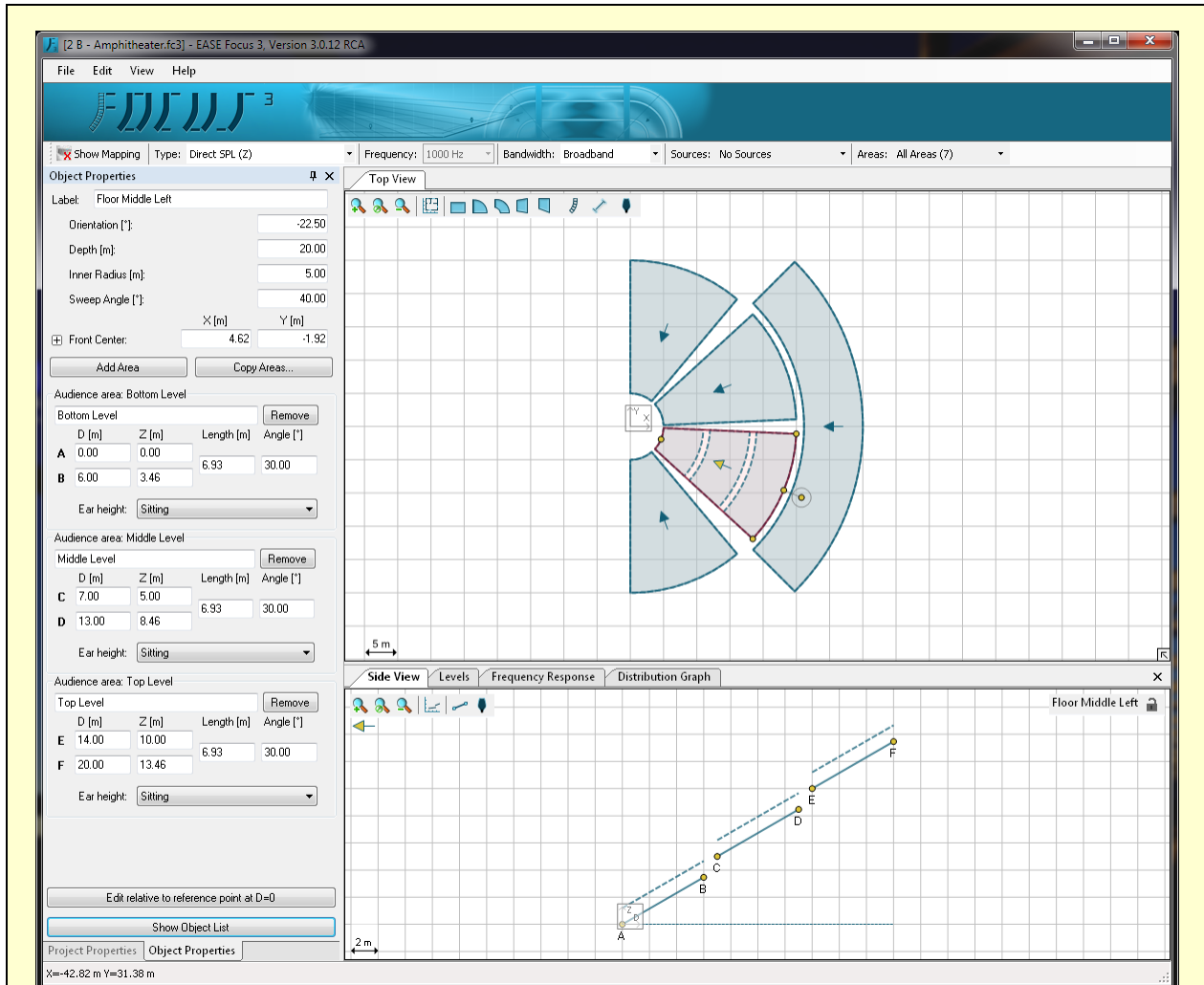

Select one of the floor Audience Zones that you have entered in the previous section, and draw three Audience Areas in it, as shown in the picture. These will be the levels of the amphitheater. Name the Areas “Top Level”, “Middle Level” and “Bottom Level.” In the next paragraph we will see how to extend levels to other Audience Zones.

2.6. Copying Areas between Zones

You might find yourself drawing a venue where several Audience Zones have a similar profile. A typical example is a stadium where all Zones could form a loop consisting of rectangles, annular and circular sectors, but circles extend across all these Zones. The solution for this situation is the “Copy Areas” operation. It can be performed in two ways:

- Context menu in Top View:** the Audience Areas must of course be defined for one of the Audience Zones. Then click with the right mouse button on that Zone: a menu will appear. Select the item `COPY AREAS`; then right click on one of the target Zones and select `PASTE AREAS`. Repeat this operation for all target Zones (you do not have to re-copy Areas every time, as they will be kept in memory until they are overwritten by another `COPY AREAS` operation).

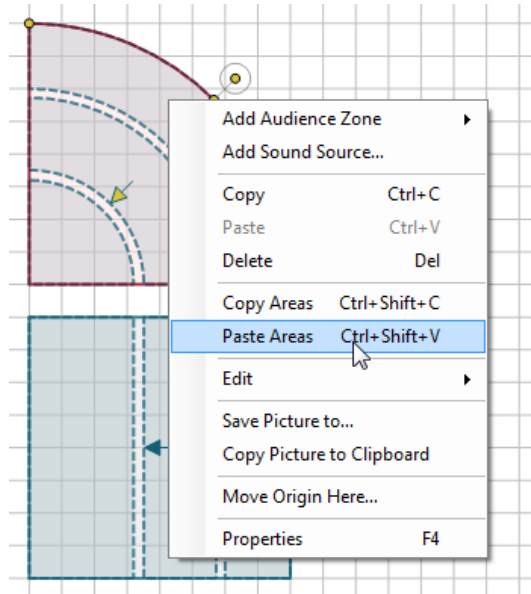

- Object Properties window:** once you have defined the Audience Area profile for one Zone, when this is selected, open the Object Properties window (if it is not showing already: either from menu `VIEW | OBJECT PROPERTIES`, or right clicking in the Top View and selecting `PROPERTIES`, or just hitting `F4`) and click on the `COPY AREAS TO OTHER ZONES` button. A dialog will appear listing all Audience Zones in the Project; click on any of them in the list to identify it in the Top View. Check all target Zones for your copy operation. Additional options on Area groups are available in the expandable section on the bottom (§4.9). Click `OK` to validate the selection and run the operation.

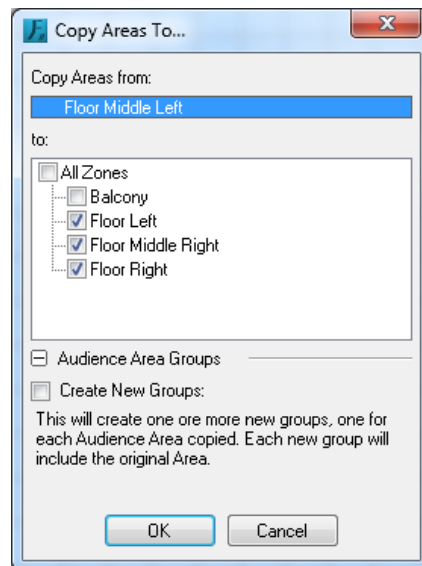

Please note that copied Areas will be adapted to the size of target Zones. However, if your Audience Zones have about the same length, no unexpected results will happen.

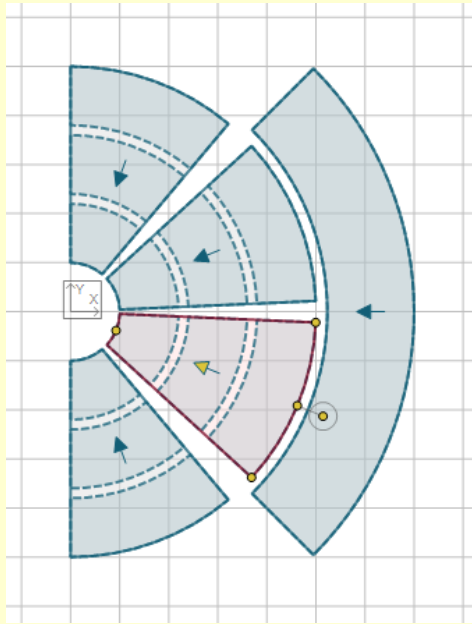

Make sure that all your floor Zones have the same depth, as it is logical in an amphitheater. Then select the Zone in which you have drawn the levels, and copy them to all other floor Audience Zones. Try both methods to do so.

2.7. Saving Projects

To save a project, click on **FILE | SAVE (Ctrl+S)**; **FILE | SAVE AS (Ctrl+Shift+S)** will save the current project to a new file, similar to most other programs. Saving a project will also pack GLL and DLL files into the file, so that it can be passed on to other EASE Focus users without having to worry about other files that are needed to open it. However, note that this could lead to quite large project files.

When a project is modified after saving, a star (*) symbol will appear next to its file name in the main window title bar. This indicates that the current project contains unsaved changes. In this case, if you try to quit EASE Focus, you will be asked if you want to save all changes. The same is true for new projects.

2.8. Loading Projects

To load a project, click on **FILE | OPEN (Ctrl+O)**. Before loading, if the project contains system definitions, that is GLL or DLL files, that are not present in your database, they will be listed in the Import System Definitions window and you will have the possibility to import every single system definition into your database using **SAVE**. Alternatively you can click **SAVE ALL**, which will store all system definition files in your database at once.

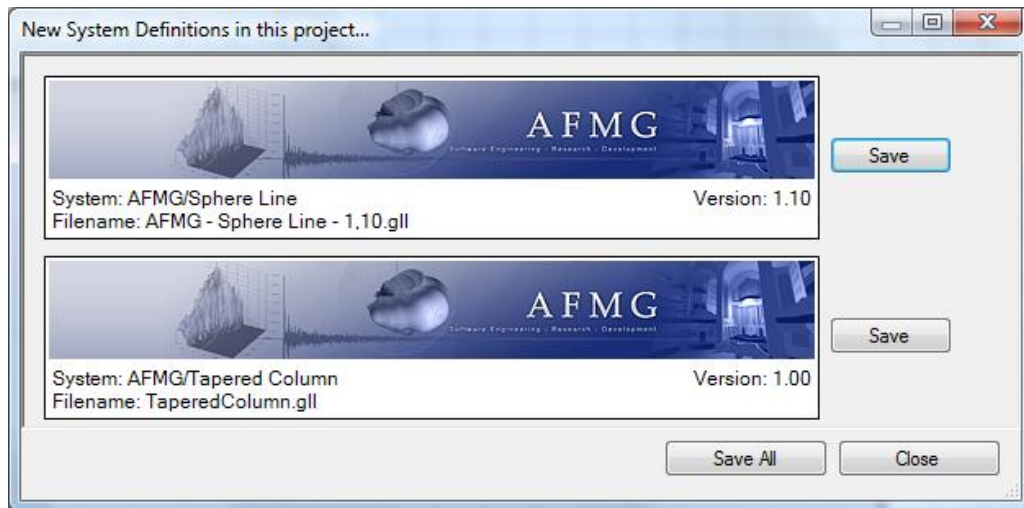

2.9. Importing and Managing System Definitions

Besides loading a project, there is another way to add compatible system definitions to the EASE Focus database. If you have one or more GLL files which are compatible with EASE Focus, you can click **FILE | IMPORT SYSTEM DEFINITION FILES**: this will open a dialog window where you can select one or more GLL files. After that, all valid sound sources will be imported directly.

Please note that GLL files must be compatible with EASE Focus in order to be usable: this means they must be line arrays or regular loudspeakers. Alternatively they can be digitally steered loudspeakers which must have a valid Focus binary file with the same name and .dll extension in the same directory. Of course, the GLL files must have been authorized by AFMG for EASE Focus.

After the import process is completed, the original or downloaded GLL files may be removed from the computer and Focus will work just as expected, since it has all data files that are needed stored internally.

It is also possible to remove (delete) system definitions from the internal database. This can be done using the menu command **FILE | MANAGE SYSTEM DEFINITIONS...** A dialog window will open where you can select the sources to be removed. Just click the corresponding systems to highlight them. All selected systems will be deleted from the database as soon as the **REMOVE** button is clicked and the process confirmed in the subsequent dialog. Systems selected on different pages will also be considered for the operation.

To make things easier, it is possible to narrow down the list using the manufacturers list on the left or by filtering using the **SEARCH:** field, which will look for manufacturers, systems, and GLL versions with the specified search words. If there is more than one page of systems, you will also be able to scan through the different pages by clicking the arrows below the list of models, by using the mouse wheel, or by pressing

Page-Up and Page-Down keys. The list is always sorted alphabetically, first by manufacturer then by name. Finally, notice that the window can be resized by dragging its bottom edge. By doing so, the number of displayed items per page can be changed.

In the lower right corner of each system definition there is a solid blue circle with the letter “i” inside of it. By hovering the cursor over this info symbol, a box will be displayed that contains the system definition details information. A unique ID number is associated with each system definition (e.g. GLL). If the system definition utilizes any plug-ins (§2.18), info about each type of plug-in contained in the system definition will be shown as well.

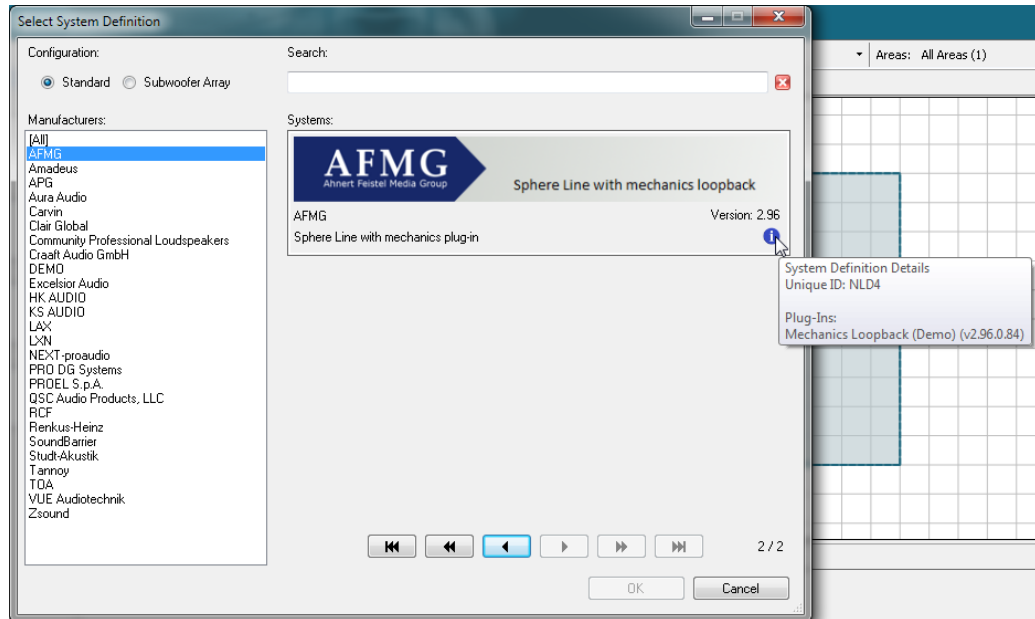

Exporting system definitions (GLL files) can be accomplished in a similar manner. This may be useful for sending the files to co-workers or partners, for example. In order to export system definitions (GLL files), select the desired sources as detailed above and press the **EXPORT** button. A new window will appear allowing you to browse to the folder where the exported files will be saved. Choose the desired top folder and press **OK** to complete the export operation.

2.10. Adding Line Arrays

To enter a Line Array or other kind of Sound Source use the insert icon  or use the RMB menu that opens when right-clicking the white background of the drawing.

This will bring up a list of available Sound Source types. Select one of them and then left-click or drag to insert it into the top view.

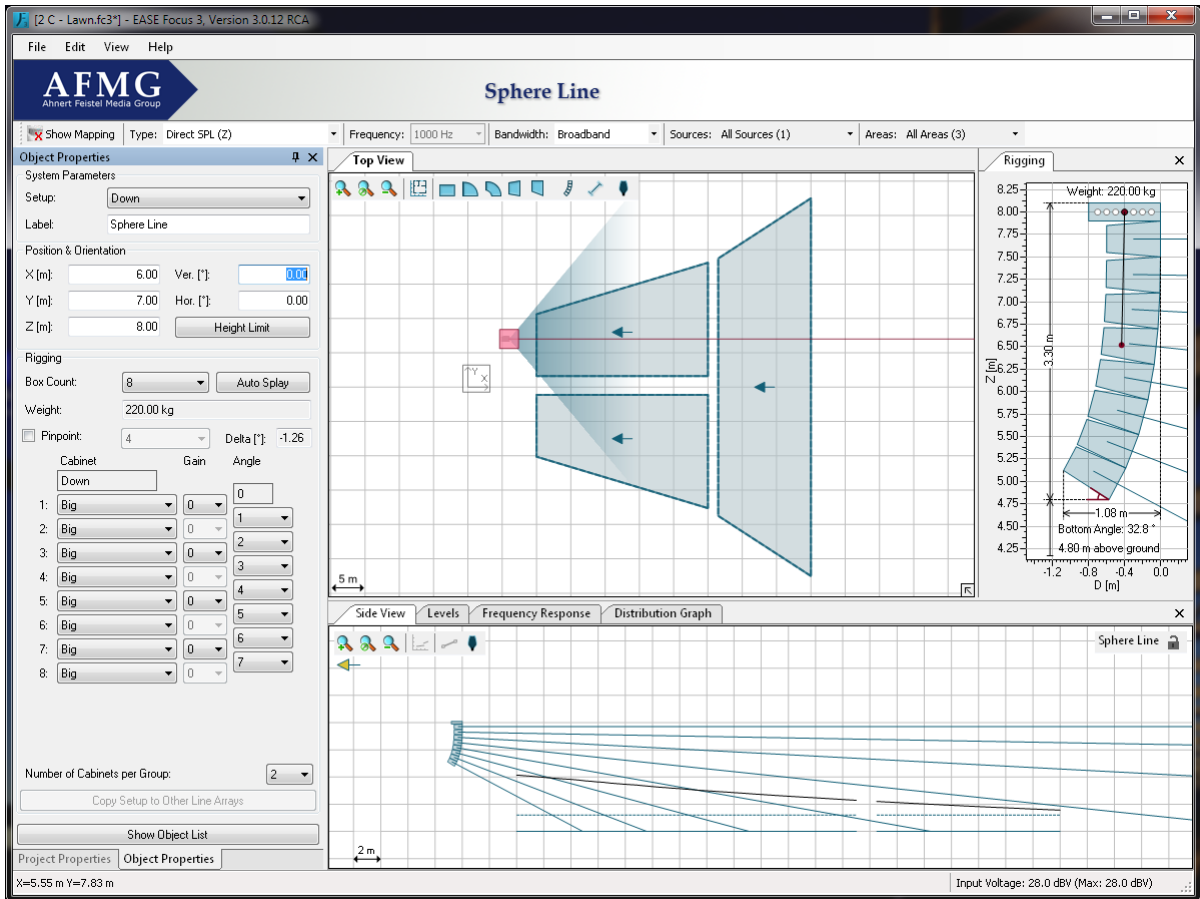

Note that for performance reasons the total number of line arrays, pre-configured subwoofer arrays, loudspeaker columns, and regular loudspeakers is limited to 40 Sound Sources overall.

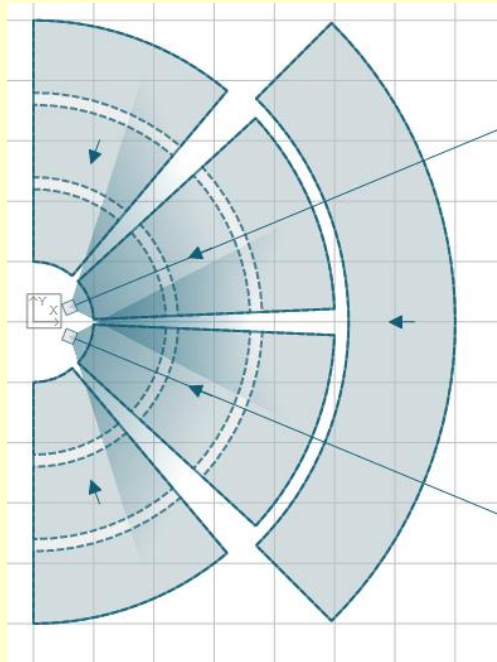

Add two Line Arrays pointing towards the two middle floor Audience Zones, as shown in the picture. You can name them after the zones where they are aimed.

2.11. Editing Line Arrays

In the Top View you can change the location of a Line Array by left-dragging the symbol; or its orientation by left-dragging the aiming line. You can do the same in the Side View, where you can also edit the height of the Array and the tilt angle of the single boxes using their aiming lines.

The same parameters can be fine-tuned in the Object Properties window, where you can define the following attributes:

- **SETUP:** lets you choose between manufacturer-defined setups. A setup can be hanging (flown) or groundstacked
- **X, Y, Z:** coordinates of the array’s reference point
- **VER:** vertical tilt angle of the frame
- **HOR:** horizontal aiming angle of the Line Array (0° = pointing right)
- **HEIGHT LIMITS:** height limits for the current Line Array. Limits can be set to Project default (§2.1) or individual for a specific Line Array.

In the **RIGGING** frame you can also change the box number and types and edit the pinpoint mode: you can set one or two pinpoints (manual) or define an angle and let Focus find the best fitting pinpoint (automatic). You can also access the **AUTO SPLAY** function (§2.12) which can help you defining an initial array configuration for a given venue, or copy the setup to other similar Line Arrays (§2.14).

If the system definition supports input filters, you will see two buttons in the Line Array properties: **RIGGING** and **FILTER SETTINGS**. Selecting **FILTER SETTINGS**, you will be able to simulate the effect of manufacturer-defined filters for specific elements of the line array (§6.5).

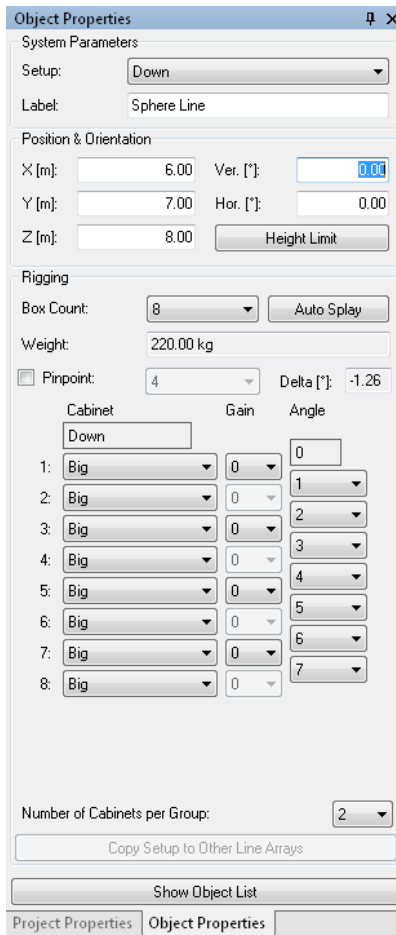

EASE Focus also supports Line Array presets: if a System Definition contains presets, these can be applied under the menu **EDIT | LINE ARRAY PRESETS**; otherwise, only default presets (**J-ARRAY**, **LINED**, **CURVED**) will be available.

Limits of various types (e.g. weight, angle) are normally specified in every system definition. If those limits are violated, errors or warning messages will be shown, both in the Line Array related Object Properties and in the status bar.

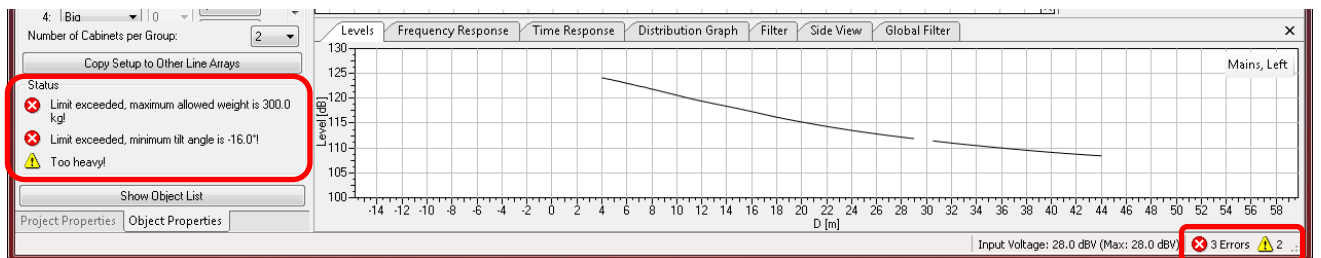

2.12. Auto Splay

The Auto Splay function is a valuable tool of EASE Focus that can save you a lot of time when starting to set up your system. Auto Splay optimizes SPL output produced by the Line Array along its aiming axis, on the Audience Areas that are crossed by it. Levels are calculated at ear height.

However, note that Auto Splay will only give you a starting point for your system configuration. Depending on the particular system, this function may not yield optimal results. Consult the respective system manual and contact the manufacturer’s technical support for more information.

To use Auto Splay, select the Line Array, go to the Object Properties (F4) and click on `AUTO SPLAY`. A dialog window will show, making options available about the boxes to be considered. One additional expandable section of the dialog window can be used to select Audience Areas to be optimized.

Another section can be used to define the Auto Splay strategy:

- `CONVENTIONAL` (default) runs the Focus Auto Splay algorithm with no constraints.
- `ARCULATE` applies a constant opening angle between adjacent boxes, if possible.
- `SPIRAL` applies a constantly increasing opening angle between adjacent boxes, if possible.
- `KEEP ARRAY TILT ANGLE` locks the current setting for the vertical angle. Otherwise this angle will also be adjusted in order to achieve the optimal coverage.

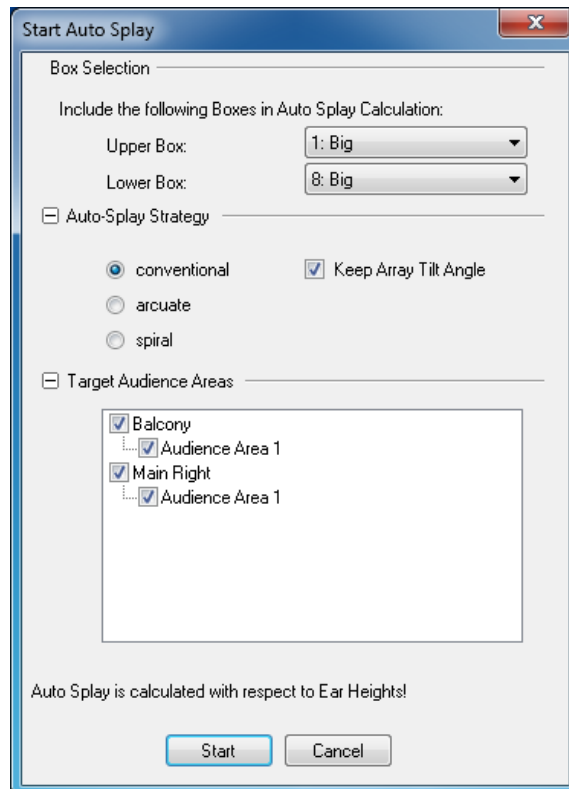

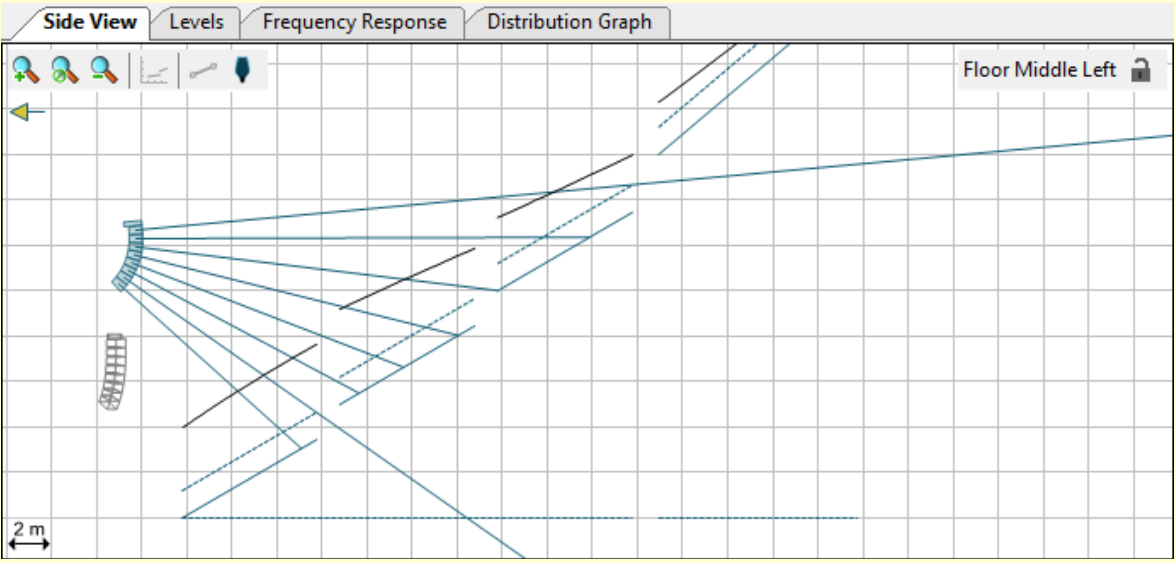

Select one of the two Line Arrays you have placed. Adjust its height, so that it is just above all levels of the floor. Set the number of boxes to 8. Now perform an Auto Splay for all boxes with all floor Audience Areas as the target (conventional strategy). Pay attention to exclude the balcony from the optimization.

2.13. Overlap Regions

The overlap coverage region between adjacent boxes in an array can be shown explicitly. Hovering the cursor (mouse) over any splay angle drop-down box highlights the overlap region, both on the Levels tab and the Side View tab, defined by this splay angle between the two boxes. On the Side View tab moving the cursor between the aiming lines will highlight the overlap region on the Level tab. It will also make the numerical value bold in the corresponding splay angle box. Moving the cursor along the display on the Level tab will also make the corresponding splay angle box bold, as well as highlight the corresponding overlap region on the Side View tab.

This interaction makes it easy to correlate a peak or dip in the SPL to a specific overlap region of adjacent boxes and their splay angle. Adjustments to the mechanical splay angle can help to make the SPL more uniform.

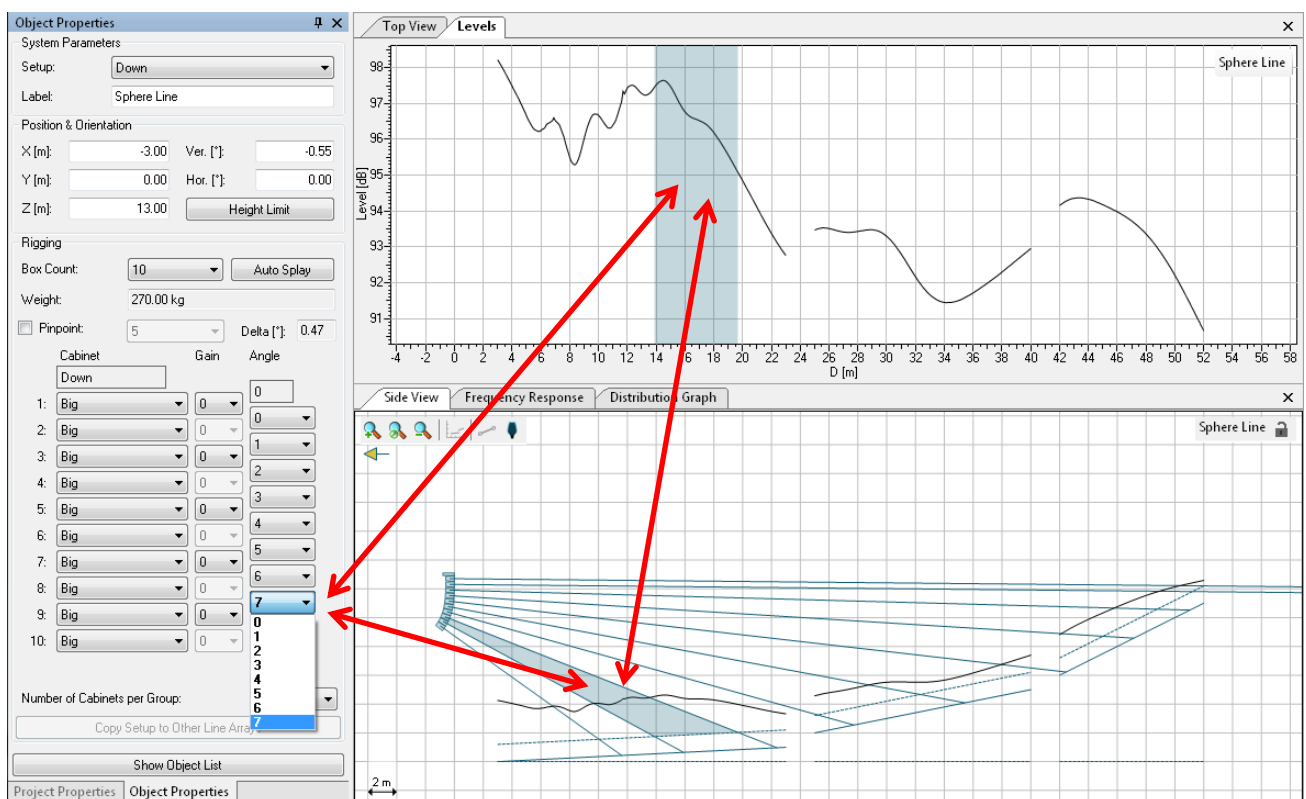

2.14. Copying Setups between Similar Line Arrays

In a situation where you have, for example, two Line Arrays in a stereo configuration, you may have to make sure that they are identical. This is why the Copy Setup function exists. Similar to the Copy Areas function between Audience Zones (§2.6), it can be performed in three ways, but only between Line Arrays of the same type.

- Paste Setup from context menu in Top View:** the rigging must be defined for one of the Line Arrays. Then click with the right mouse button on that Source, and select the menu item `COPY SETUP`; then right click on each one of the target Sources and each time select `PASTE SETUP`. A copied setup will be kept in memory until it is overwritten by another “Copy Setup” operation.

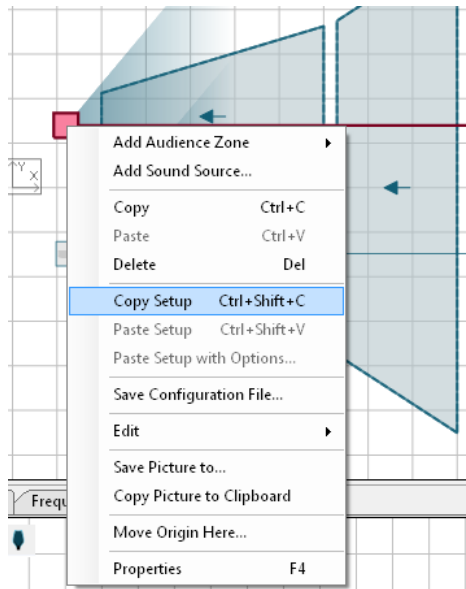

- Paste Setup with Options:** Extending the functionality of PASTE SETUP, clicking PASTE SETUP WITH OPTIONS for the target array will display a window allowing the choice of which settings will be transferred to the target array. Pressing OK confirms the operation for the selected items.

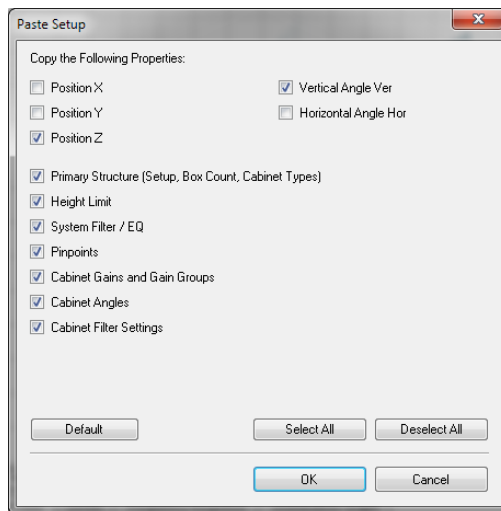

Internally to EASE Focus this is quite a complicated function since some of the settings depend on other settings and finding the best match in every scenario is not always easy. EASE Focus will let you know it will try to find the best match through a note in that window at the bottom, if necessary.

*Please note: If settings are nominally incompatible the best match will be used.

The function PASTE WITH OPTIONS is particularly useful for symmetrical setups or for distributed systems where only some properties should be copied without overwriting other properties.

Please note that PASTE WITH OPTIONS is not available for conventional loudspeakers or custom sound source DLLs, but only for line arrays.

- **Object Properties window:** once you have defined the rigging setup on a selected Line Array, open the Object Properties and click on the `COPY SETUP TO OTHER LINE ARRAYS` button. A dialog will appear listing all similar Line Arrays in the Project; click on any of them in the list to identify it in the Top View. Check all desired target Line Arrays for your copy operation, and click `OK` to validate.

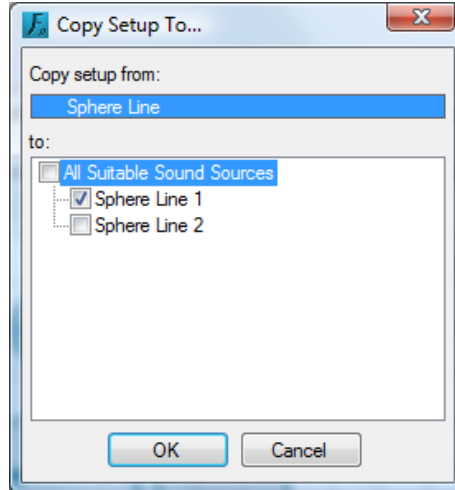

Note that the copied information will include box count and types, tilt angles and filters along with global tilt angle and height of the Line Array: this is all the information that has to do directly with rigging setup. Horizontal angles and XY position will not be copied.

Setups can also be copied between Loudspeakers, such as steerable columns (\$0): in this case, height and tilt angle will be copied, along with all setup information internal to the loudspeaker library.

Copy the setup you created to the other Line Array. Try it first with the context menu method, then undo the operation (Ctrl+Z) and try it again from the Object Properties.

2.15. Regular Loudspeakers, Steerable Columns

Although EASE Focus was designed to be a tool for the aiming of line arrays primarily, you can load and configure regular loudspeakers, as well. This is useful in order to account, for example, for the effect of down-fill or delay loudspeakers in a complete model of the sound system in the venue.

All program functions that are available for line arrays are also available for regular loudspeakers. The only difference is that the properties window for loudspeakers is much simpler than that for line arrays. It allows entering the label of the sound source as well as its location and orientation. If input configurations are allowed by the system definition (GLL file), these can be selected in the loudspeaker properties window as well.

Note the FILTER SETTINGS area shows some of the same properties (GAIN, DELAY, and INVERT POLARITY) that are also on the FILTER tab (this tab is only shown when using the Extended Mode, §5.3). Having these three properties available in the Object Properties area should give better access to them for optimizing the directivity of discrete arrays that are built manually (i.e. manually configured subwoofer arrays §3.2).

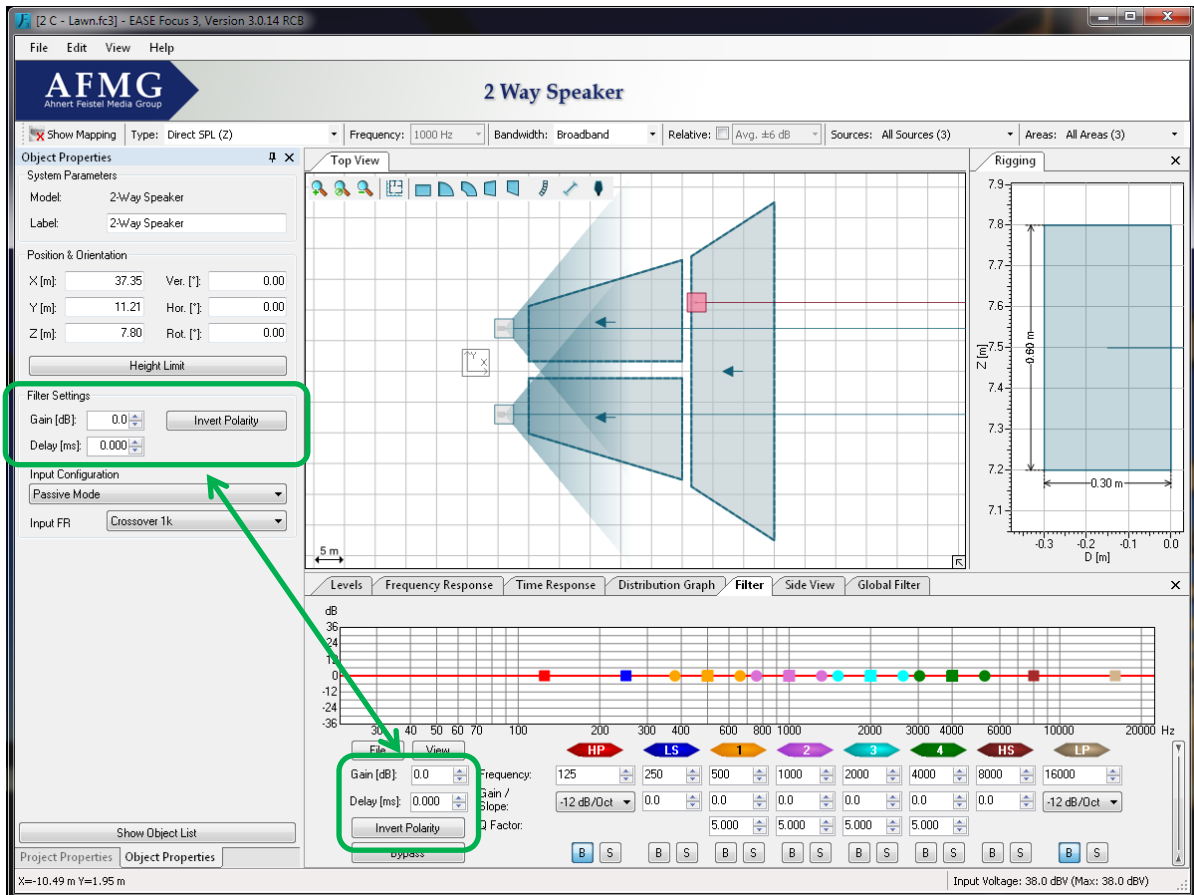

EASE Focus also supports Configurable Loudspeakers, such as digitally steered columns, which typically work with a filter/delay system applied to their acoustic transducers. This is possible thanks to an external DLL file, which ships together with the GLL and implements all that is needed to display the graphical aiming interface and the custom mask, and to communicate to Focus the information about filters in the acoustic sources.

Beginning with version 3.1 of EASE Focus, the functionality of steerable column loudspeakers can also be augmented with the GLL plug-in architecture (§2.18). All of the graphical aiming interface and communication with Focus can be fully embedded within the GLL, via the plug-in, without the need for an external DLL.

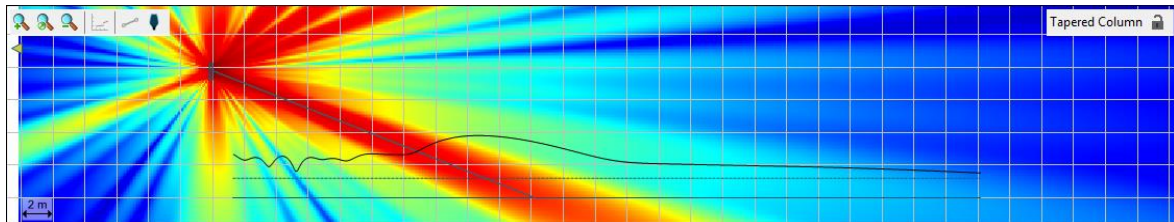

| AFMG | | | |
|------------------|----------------|-----------|------|
| Type: | TaperedColumn | | |
| Label: | Tapered Column | | |
| X [m]: | -1.26 | Ver. [°]: | 0.00 |
| Y [m]: | -0.98 | Hor. [°]: | 0.00 |
| Z [m]: | 8.24 | | |
| Beam Tilt Angle: | -21.08 | | |

2.16. Moving Active Sound Sources

It may be desirable to move a group of loudspeakers such as a manually configured subwoofer array or a group of front fill loudspeakers. This can be accomplished using the `MOVE ACTIVE SOUND SOURCES` command. This is available from the `EDIT` menu item and also with the `Ctrl+M` hotkey. It allows full control to move the currently active sound sources in 3D and to rotate them within the horizontal plane.

In order to activate the sources to be moved, and to deactivate the ones that should not be moved, simply select them through the `SOURCES`: dropdown menu on the Mapping Toolbar. Notice that groups of sources can also be created so that they can be turned on/off more quickly. In the screen shot below there is an example where only the front fill loudspeakers have been activated.

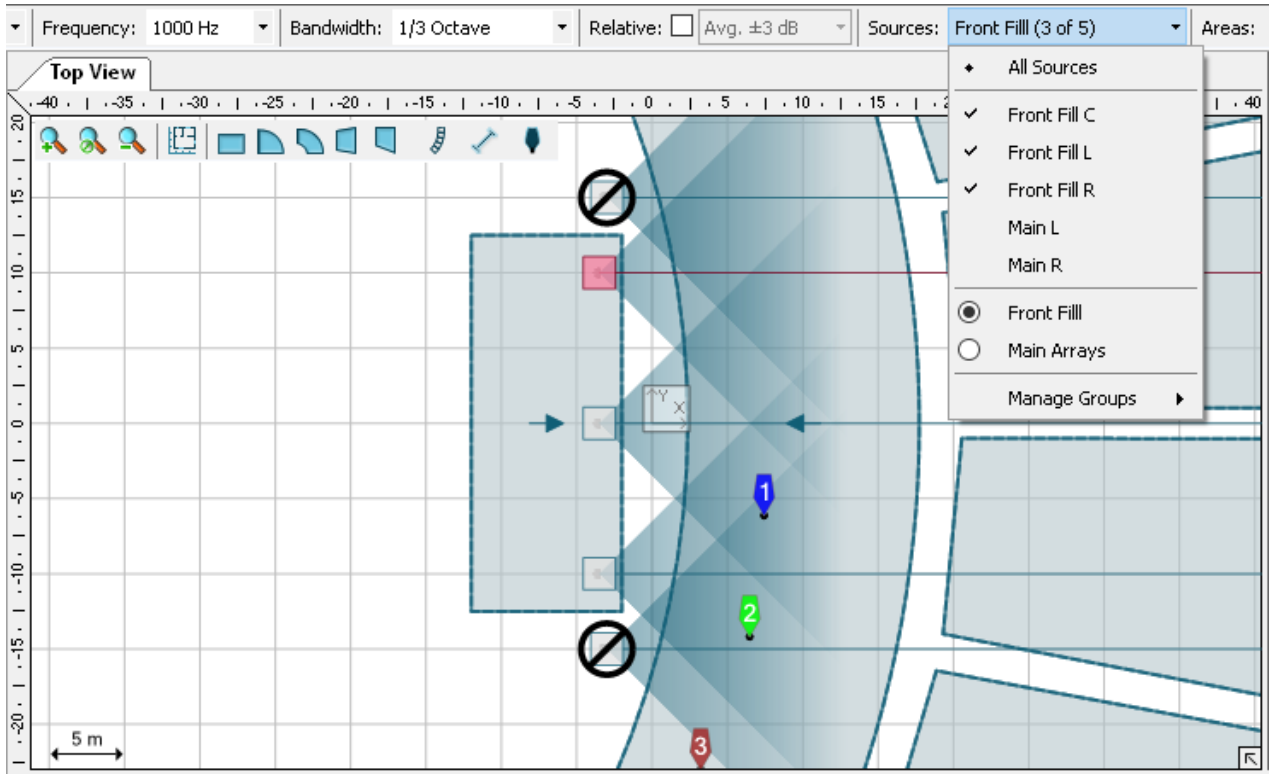

After selecting the sources to be moved, click on **EDIT | MOVE ACTIVE SOUND SOURCES**. The following dialog box will be shown with control buttons to displace the active loudspeakers by the amount specified in the **STEP** fields.

- ΔX buttons move the sources along the positive X axis [Ctrl + →] and negative X axis [Ctrl + ←]
- ΔY buttons, along the positive Y axis [Ctrl + ↑] and negative Y axis [Ctrl + ↓]
- ΔZ buttons, along the positive Z axis [Ctrl + Page↑] and negative Z axis [Ctrl + Page↓]
- $\Delta HOR.$ buttons rotate the sources clockwise [Ctrl + +] and counterclockwise [Ctrl + -] around the center of geometry

All displacements are done interactively, while the window is open. After closing it, the total displacement can be easily undone [Ctrl + Z] if needed.

2.17. Snap to Loudspeaker and Stacking Loudspeakers

There are some applications where one might want to stack loudspeakers, or simply position a box right above another box. The Snap to Loudspeaker function allows you to easily perform this action. The example below shows a front-fill loudspeaker positioned over a stack of two subwoofers.

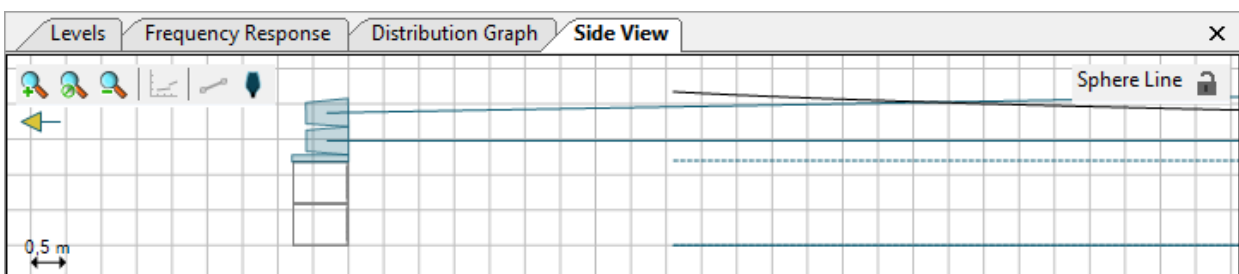

This can be accomplished in the Top View, by holding the [Ctrl] key and with the mouse dragging a loudspeaker close to another loudspeaker. The loudspeaker being dragged will automatically be placed on top of the other loudspeaker, adjusting its X and Y coordinates, as well as its height (Z coordinate) and its horizontal angle. This can also be done with other loudspeaker types, such as a stack of line array loudspeakers over subs.

The process of stacking subwoofers in a straight subwoofer array can actually be accomplished using the Subwoofer Array feature, with just a few clicks in its properties window. However, for manually built arrays (usually not straight) the process of manual placing the individual boxes can be greatly simplified using this snap function.

Also, ground-stack line array systems might be defined directly from the Setup drop-down menu in the line-array properties. However, the manual positioning with snapping might be useful whenever two different manufacturer’s loudspeakers are used for the subwoofers and the line array.

Note that the snap function also works for a dragged loudspeaker if there is no loudspeaker below. In this case the loudspeaker will snap to $Z = 0$ based on the geometry of the enclosure. This makes it very easy to place loudspeakers exactly on the ground when their reference point is somewhere inside the box.

While the [Ctrl] key is pressed, other existing snap-to-grid features are temporarily disabled so that this Snap to Loudspeaker function is enabled.

2.18. Plug-Ins

With the introduction of EASE Focus 3.1, it is possible for individual manufacturers to extend the functionality of their System Definitions (i.e. GLL files) in a customized manner through the use of plug-ins. These plug-ins are imbedded within the System Definition files themselves. A System Definition that contains one or more plug-ins can be identified when managing the System Definitions (§2.9). Hovering the cursor over the info symbol (e.g. the solid blue circle with the letter “i” inside of it) will display a box that contains the system definition details information. If the system definition utilizes any plug-ins, information about each type of plug-in contained in the system definition will be shown.

Plug-ins can be used to:

- Display custom messages based on the array configuration
- Access a secondary properties window specific to the loudspeaker system
- Apply a specific set of filters based on the array configuration
- Include additional data in printed reports
- Store and load additional data with EASE Focus projects

The use of plug-ins can greatly enhance or automate beam-steering functionality and customized filter selections. They can also be used to enable safety calculations for array configurations, to add packing lists to the printed report, and for showing specific mechanical information for line arrays.

2.19. Secondary Properties Window

Some System Definitions, i.e. GLL files, provide a product-specific, custom-designed GUI window. If the GLL file uses the plug-in technology, its custom window will be displayed by default at the same location as the Rigging window.

The window will have a custom title as well, such as “Loads” or “Filter Settings”. In EASE Focus, however, this custom window is generically called the `SECONDARY PROPERTIES WINDOW`. This is also the label that the `VIEW` menu entry shows for managing the window layout.

Please notice that the content of the Secondary Properties window is defined completely by the creator of the GLL and the plug-in. AFMG is not responsible for its design, look, or functionality. If the plug-in shows severe defects or abusive implementations please inform AFMG technical support (support@afmg.eu).

If the project contains sound sources supporting a Secondary Properties window, the Secondary Properties window will be visible. However, the Secondary Properties window will be empty if the sound source does not provide a custom window. The menu entry `VIEW | SECONDARY PROPERTIES (TITLE)` in the main menu allows switching the display of the Secondary Properties window on and off.

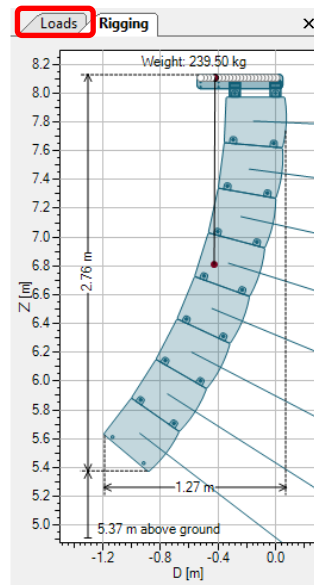
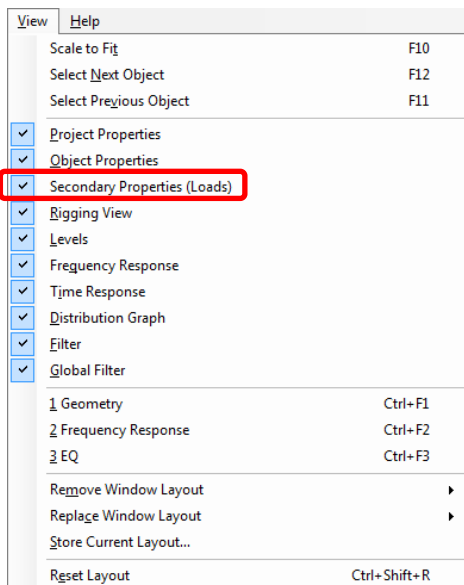

3. Subwoofers

The use of subwoofers and subwoofer arrays are supported in Focus 3. As defined in Focus 3, a Pre-Configured Subwoofer Array is a group of identical subwoofer-type loudspeakers. The placement of each subwoofer box relative to each other and the signal delay used for each box in the array is controlled automatically by Focus for pre-configured subwoofer arrays. Discrete, manually configured arrays of subwoofers are also possible. Manually configured arrays must be built by the user; placing each box in the desired location and specifying the desired signal delay time for each box.

3.1. Pre-Configured Subwoofer Arrays

For pre-configured subwoofer arrays, EASE Focus automatically calculates the proper location of each box in the array, relative to the other boxes, and the required delay times to produce a desired coverage for the subwoofer array. In this software version the only possible shape is a linear, evenly spaced array of subwoofers.

To add a pre-configured subwoofer array to an EASE Focus project click the **ADD SOUND SOURCE** icon or select **EDIT | ADD SOUND SOURCE (CTRL + ALT + L)**, just like adding any other sound source. In the **Select System Definition** dialog box choose **SUBWOOFER ARRAY** at the top under **CONFIGURATION**. This will do two things. First it will limit the systems shown on the right side of the dialog box to those GLLs that are defined as subwoofer GLLs. Secondly, when the **OK** button is clicked to add the selected sound source to the project it will be added as a subwoofer array, not as an individual loudspeaker.

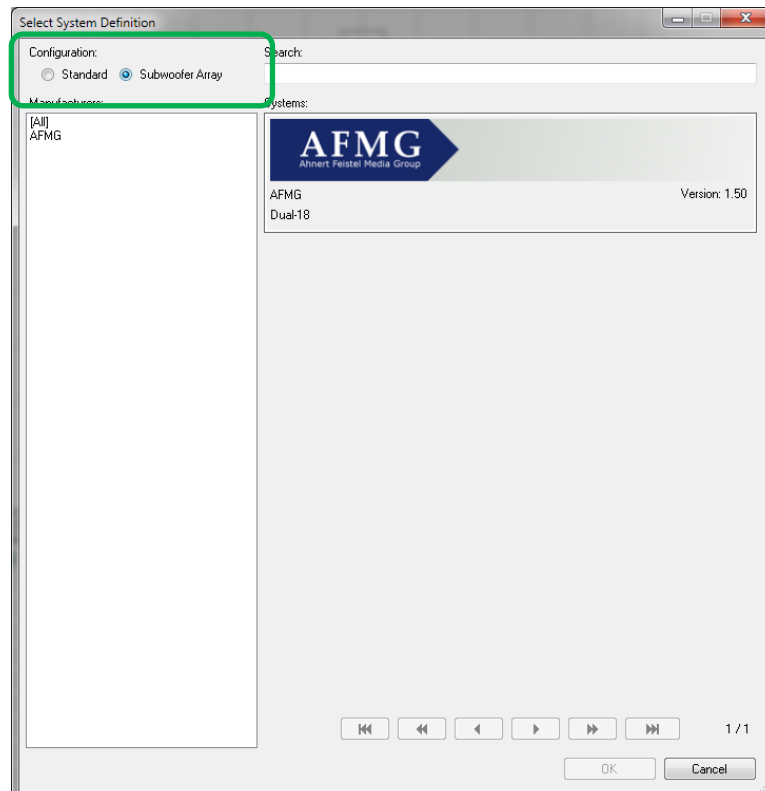

Notice the special icon in the Top View indicating the subwoofers linearly spaced array. It will look like one of the pictures shown below. In the left picture the array shown is symmetric (default). The array shown on the right is asymmetric. The location of the first box and the “on-axis” handle is different for symmetric or asymmetric arrays. For arrays with an even number of boxes, it will be located between the two center boxes.

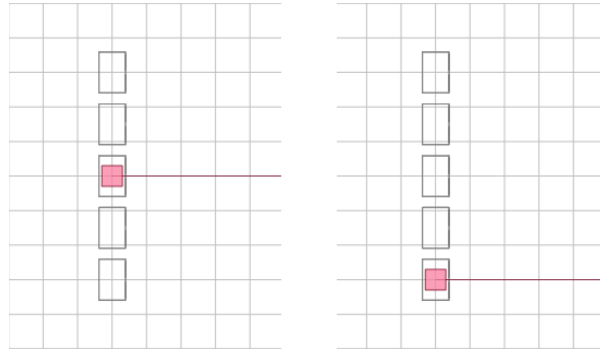

The Object Properties for a subwoofer array are different than for other types of loudspeakers. Clicking on the subwoofer array in the Top View will show the properties.

The first option is the array setup, which can be symmetric or asymmetric with respect to the source location. Selecting the SYMMETRIC setup will place the individual sources symmetrically with respect to the center of the array, distributing loudspeakers evenly on each side. The ASYMMETRIC setup will place sources only on one side of the array. The two options will be clearly distinguished in the Top View (see previous picture).

Object Properties ⏏ ×

System Parameters

Model:

Label:

Setup: Symmetric Asymmetric

Position & Orientation of Center

X [m]: Hor [°]:

Y [m]:

Z [m]:

Configuration

Box Count:

Stacked Boxes:

Array Width [m]:

Coverage Angle [°]:

Spacing [m]:

Approx. Frequency Limit [Hz]:

Box Locations & Delays

| # | X [m] | Y [m] | Z [m] | Delay [ms] |
|---|-------|-------|-------|------------|
| 1 | 0.00 | -3.00 | 0.00 | 3.2 |
| 2 | 0.00 | -1.50 | 0.00 | 0.4 |
| 3 | 0.00 | 0.00 | 0.00 | 0.0 |
| 4 | 0.00 | 1.50 | 0.00 | 0.4 |
| 5 | 0.00 | 3.00 | 0.00 | 3.2 |

The POSITION & ORIENTATION OF CENTER section defines the reference location for the array, according to its center (for symmetric arrays) or according to the first box (for asymmetric arrays). Note that all loudspeaker locations in the subwoofer array are relative to this reference position, including the horizontal angle of the array. This can be verified in the BOX LOCATIONS & DELAYS section of the Object Properties. For instance, in the screen shot above the first subwoofer box is located at -3.0 meters from the reference location of the array (in this case, the center). The third subwoofer box is located at the reference point, or center, of the array. Note the zero meter distances from the reference location. This convention should make the system implementation in the venue a much easier process compared to when absolute coordinates are used.

In the CONFIGURATION section complementary definitions for the array can be specified. The BOX COUNT parameter selects the number of subwoofer boxes that are to be placed horizontally in the array. These will make up the main structure of the array. The STACKED BOXES drop-down box selects the number of subwoofer boxes to be stacked on top of each other to form columns. Thus the total number of subwoofer boxes used in an array will be the number specified in the BOX COUNT times the number specified in the STACKED BOXES.

It is possible to either specify the ARRAY WIDTH, and let Focus calculate the spacing between each subwoofer box (or columns of subwoofer boxes), or specify the desired SPACING between the center of adjacent subwoofer boxes, and let Focus calculate the corresponding array width. Either way, the distance between the elements in the array will dictate the APPROXIMATE FREQUENCY LIMIT [HZ] for the array. The smaller the spacing between elements the higher the frequency for which the coverage pattern can be controlled.

The COVERAGE ANGLE [°] field can actually be used to specify the desired coverage and let Focus do the delay calculation work. For a desired goal, delay values for each element will be automatically calculated and the results will be mapped for verification. Notice that the possible minimum coverage angle will largely depend on the array size. In other words, a large array width is required for a small coverage angle at low frequencies.

Note that on the one hand the maximum frequency limit is governed by the spacing between elements. While on the other hand the minimum coverage angle is dictated by the array width. It is clear that for good narrow coverage and considerable bandwidth, the array must be composed of a large number of elements closely spaced. The degree to which this criterion is met defines the compromise for the project.

Notice, that only system definitions (GLLs) of Loudspeaker type can be used for pre-configured subwoofer arrays. These GLLs also need to be enabled explicitly in EASE SpeakerLab for use with such pre-configured subwoofer arrays. This aspect of the GLL must be taken care of by the creator of the GLL.

Finally, if input configurations or filter settings are defined in the system definition (GLL file), these can be selected from the subwoofer-array properties window. If available, the section can be viewed after scrolling down the Object Properties tab.

An example of the subwoofer array capabilities is illustrated below showing the coverage control. This array is comprised of 8 columns with 2 stacked subwoofers (2x 18 inch drivers in each box), spaced 1.5 m apart. The coverage angle goal is set to 40 degrees.

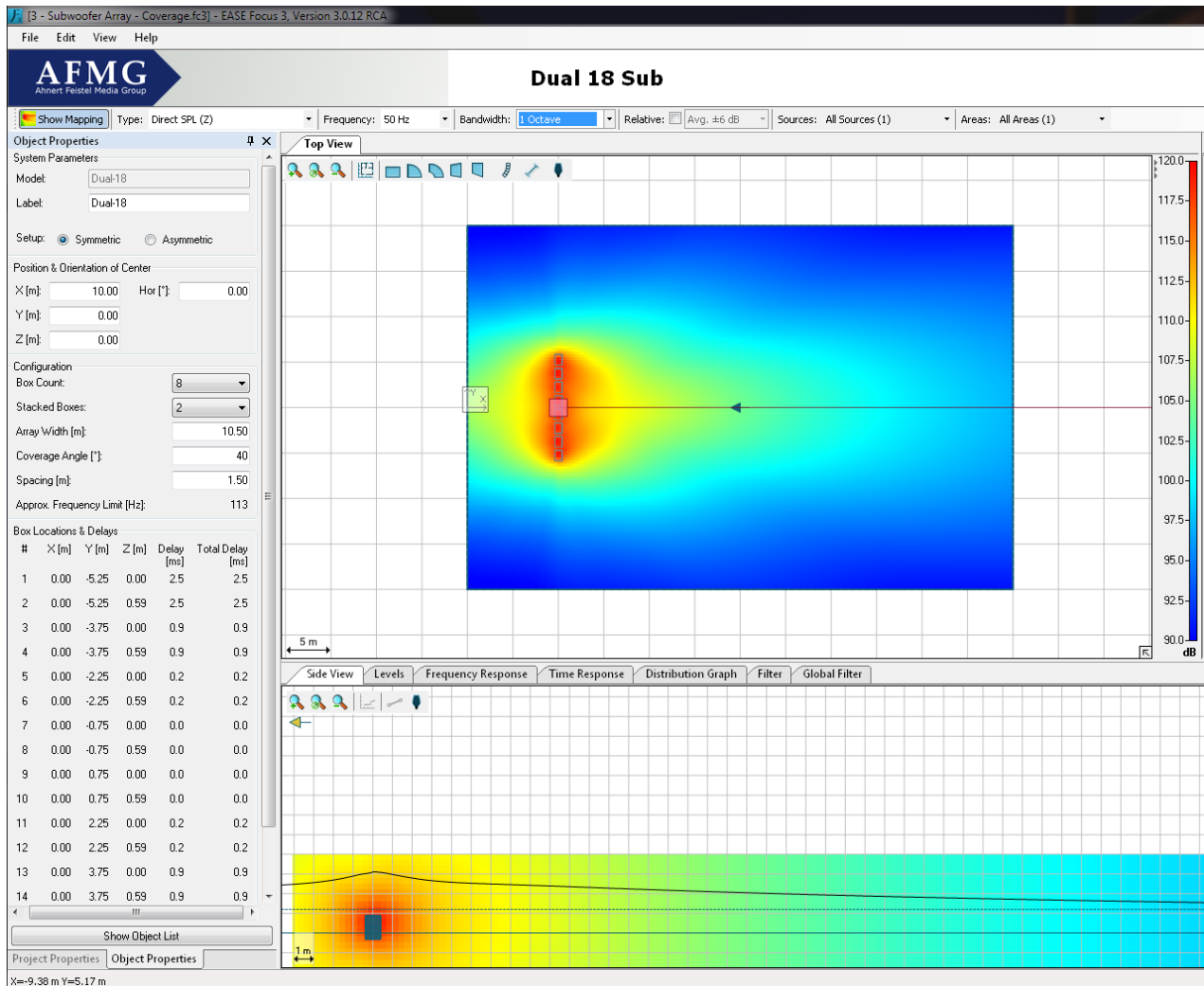

3.2. Manually Configured Arrays

Manually configured subwoofer arrays are another way to build subwoofer arrays in EASE Focus. Note that this is different than the Pre-Configured Subwoofer Arrays feature detailed in §3.1 which allows boxes within a defined subwoofer array to be positioned automatically by EASE Focus based on entering a few setup and performance parameters.

Building manually configured arrays allows much more flexibility. Many more types of subwoofers arrays are possible such as end-fire, simple cardioid, stacked cardioid, asymmetrical cardioid, etc. When building manually configured subwoofer arrays it is necessary to adjust the gain, delay, and polarity of the different boxes that make up the array to yield the desired directivity. To make this easier in EASE Focus these three loudspeaker properties are now more readily available as detailed in §0.

Modeling manually configured subwoofer arrays is possible via complex summation (i.e. both magnitude and phase) in the low frequency region within Focus. Users should acquaint themselves with this feature detailed in §4.3.

Some examples of manually configured subwoofer arrays are shown below. In each case the mapping is for 50 Hz and a bandwidth of 1/3 octave.

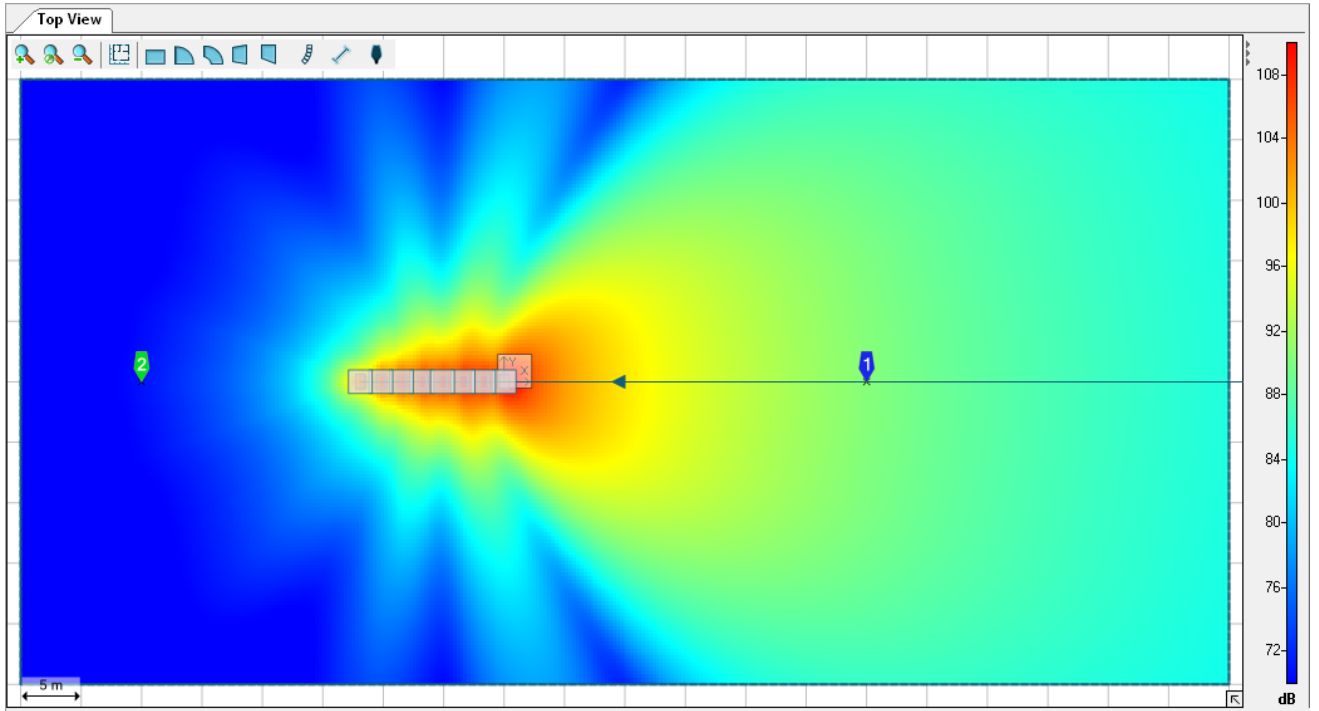
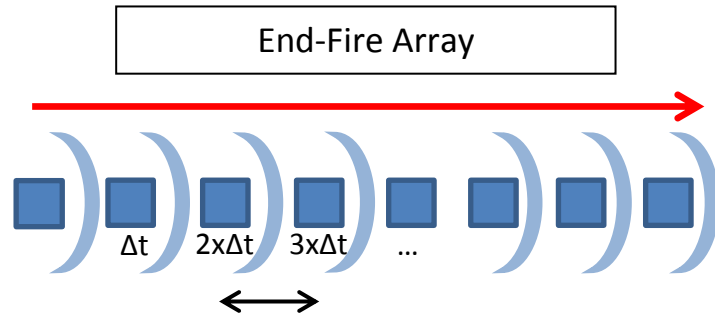

Stacked Cardioid Array

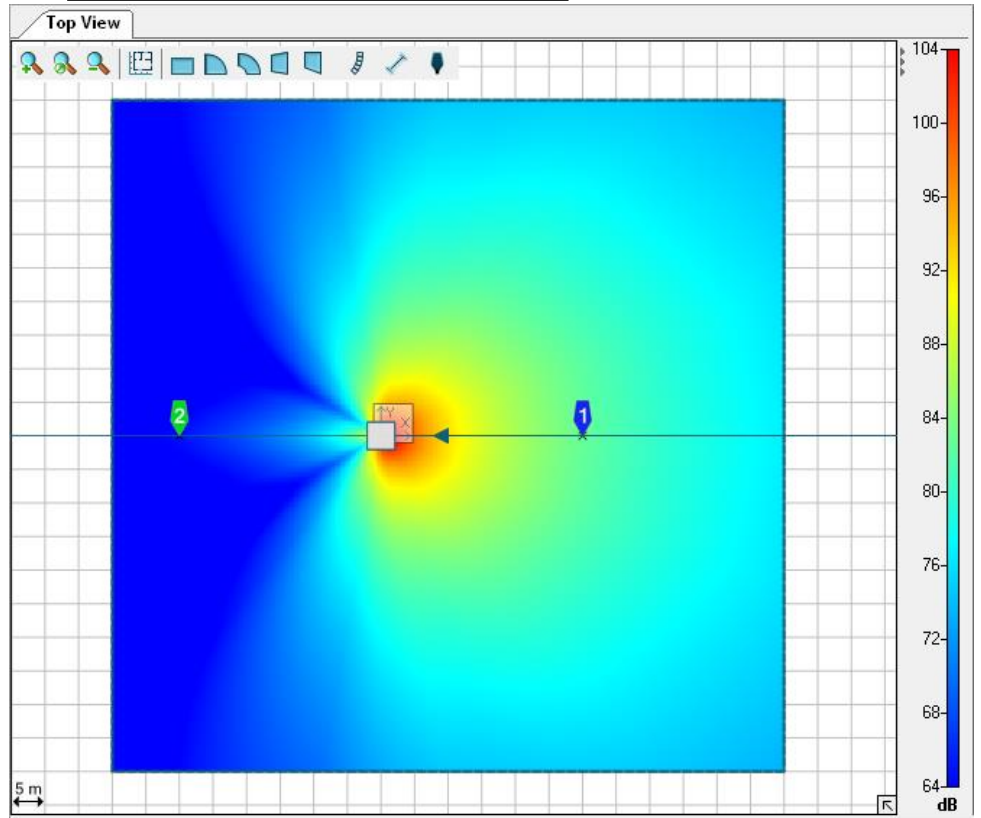
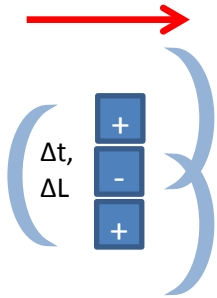

Asymmetrical Cardioid Array "Vortex"

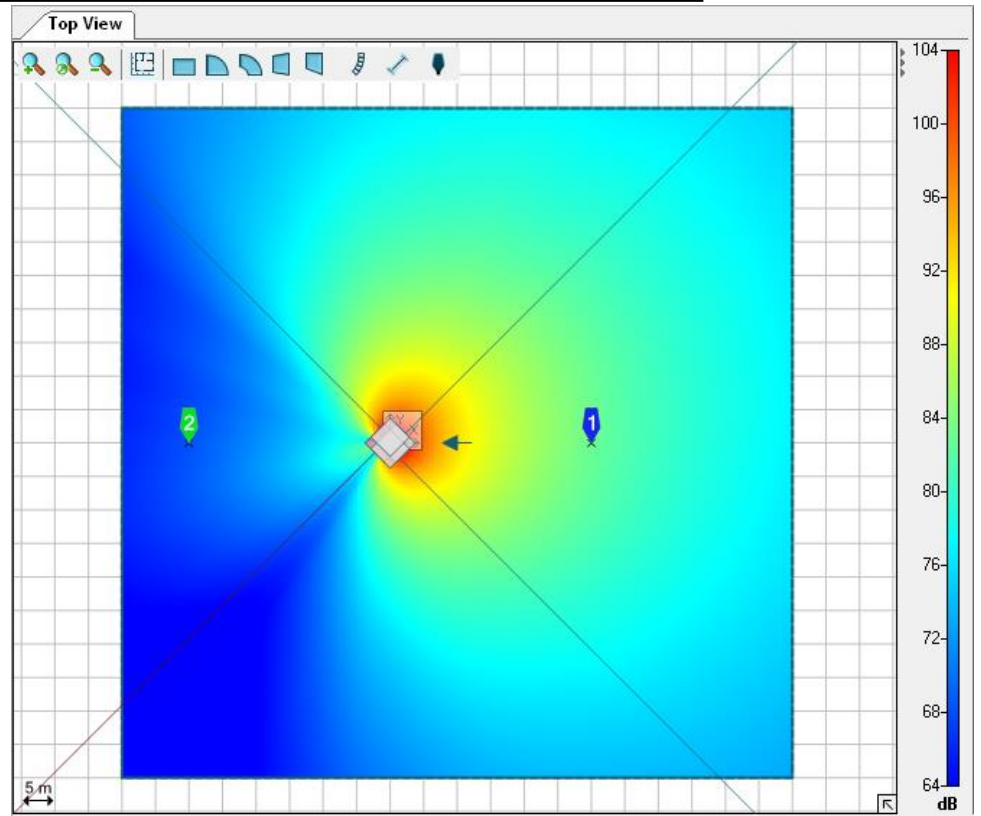
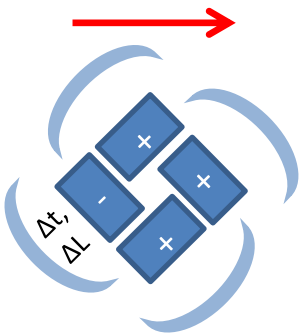

4. Mapping and Calculation Results

This chapter explains how to exploit the calculation and mapping capabilities of EASE Focus, in order to have an optimal view of how your setup works in the field.

4.1. Mapping Toolbar

The Mapping Toolbar is located by default on top of the main window, just beneath the Logo panel. This is the place where you can edit the main parameters about how a mapping is calculated and drawn.

To enable the SPL mapping display, select `SHOW MAPPING`.

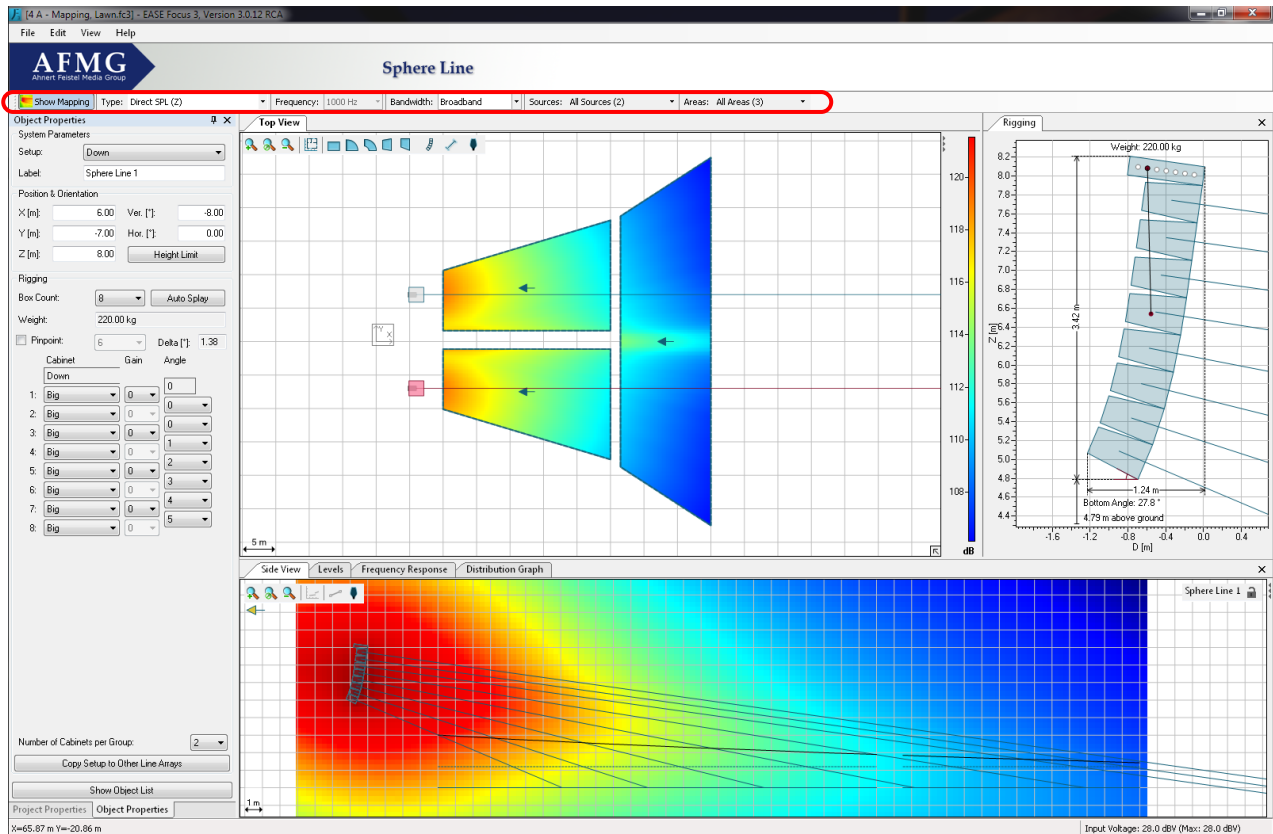

Use the `TYPE` dropdown menu to select the weighting (`Z` – none or `A`-WEIGHTING) or the `SIGNAL TO NOISE` mapping (only in Extended mode, see §5.3 on how to activate it; `NOISE SETTINGS` that are defined will apply, see §6.11). Use the `FREQUENCY` and `BANDWIDTH` dropdown menus to select the kind of mapping to be shown, either broadband or band-limited (1/3 octave, 1 octave, 3 octaves) and in the latter case the center frequency. You can use the `RELATIVE` option and menu to highlight areas whose pressure value lies outside a certain tolerance margin from the average value. Finally, you can use the `SOURCE` and `AREAS` menus to select which Sound Sources and Audience Areas are to be included in the mapping, and to store and recall Source groups (§4.8) and Area groups (§4.9).

4.2. Calculations Background

All SPL calculations in EASE Focus are limited to the direct field. Also included in the calculation are air attenuation effects according to ISO 9613. Shadowing and ground or side wall reflections are not considered. Wind effects are also not taken into account.

EASE Focus 3 uses a simplified model for treating combinations of sound sources.

- Elements within an individual line array or column are always summed in a complex manner, which means that full signal coherence is assumed. This may overestimate pressure summation and cancellation effects among elements of the array, especially for very tall systems and windy environments. But it has turned out to be a good approximation in practice.
- The summation between different line arrays, subwoofers, and loudspeakers/columns is by default calculated using power summation (based on a random-phase assumption) for the mid and high frequencies and complex summation for the low frequencies (assuming full coherence). This may underestimate the level of coherence among several line arrays in the mid-frequency range when they have the same configuration and are placed very close to each other. Nevertheless, for most practical setups this hybrid approximation is more feasible than either power summation or complex summation alone.

Note that the user can select how the summation is calculated between different line arrays or loudspeakers/columns using either complex or power summation. Complex summation up to a frequency of 250 Hz is the program default. See §4.3 for additional details.

Absolute SPL calculations in EASE Focus assume a broadband excitation with a signal that is like program material. You can choose among three different types of input signal, see §4.3. Level values displayed in the mapping or in the frequency response are sum levels. This representation is equivalent to the readings one can take from real-time analyzers (RTA) and sound level meters (SLM).

Note that in EASE Focus each sound source is always driven at its maximum input level. This means that if you assign a gain of -6 dB to each cabinet of the array, the output SPL will be unchanged. That is because the maximum input voltage is increased by 6 dB while the sensitivity of the system is decreased by 6 dB. The only exceptions from this are the Filter and Global Filter functions. They can be employed to adjust output levels of different arrays relative to each other. The current input voltage and the maximum input voltage for the selected line array system are shown in the status bar.

Be aware that the maximum input levels displayed in EASE Focus are only estimates based on the manufacturer specification and an ideal input signal. Just like the SPL prediction for the receive location these results should be considered with care and are only accurate under the given limitations and uncertainties.

For more detailed investigations please consider using the EASE software instead. Also consult the publications by AFMG for more information about the theoretical background and the computational models. Keep in mind that EASE Focus is just a tool implementing an acceptable compromise between ease-of-use, calculation speed and accuracy based on its main purpose of use.

4.3. Mapping Options

To access mapping options, select the menu `FILE | OPTIONS` or press F9. Then select the `CALCULATION PARAMETERS` list item. Here you can choose the calculation resolution for your mappings: this will affect the patch size of your calculations. Note that the number of points to be calculated increases by about 10 times for every resolution level. Lower resolutions are computed first, and their result displayed while higher resolutions are being processed. You can click on the mapping progress bar located bottom right of Top View and Side View to read alternatively the remaining time until the current resolution is completed or the total time until calculations are finished.

The `INPUT SIGNAL TYPE` chooses the spectral content of the signal used to drive the input to all of the loudspeaker systems in EASE Focus. The `PROGRAM (IEC268)` has the spectral content of the noise specified in the IEC 60268-5 standard. `MUSIC (EIA426B)` has the spectral content of the noise specified in the EIA 426-B standard. Both of these have less energy at the higher frequency regions (above approximately 1 kHz). The Program (IEC268) also has slightly lower energy at frequencies below about 100 Hz. Both of these selections can be used to better determine the maximum SPL from loudspeaker systems as they more closely resemble the spectral content of program material (i.e. music or speech) than pink noise. The last selection, `PINK NOISE (AES2 BROADBAND)`, is simply pink noise. This is a good choice when checking the frequency response of loudspeaker systems in Focus 3.

The `SOUND PRESSURE SUMMATION` selection only affects the summation between different sound sources in EASE Focus (i.e. individual instances of GLLs). This setting can be used to control the type of summation used between different instances of line arrays, between different instances of loudspeakers, and between different instances of line arrays and loudspeakers. This makes it possible to build discrete arrays using multiple instances of a loudspeaker. One such application would be building manually configured subwoofer arrays by manually arranging individual boxes.

When `POWER SUM (INCOHERENT)` is selected the summation between different sources will be calculated using a power summation which disregards phase information and relative propagation delay. This is the calculation method used in versions of EASE Focus prior to EASE Focus 3.

When `COMPLEX SUM (COHERENT)` is selected an additional parameter also needs to be chosen. This is the frequency up to which complex summation is used. Below this frequency complex summation is used. Above this frequency power summation is used. It should be noted that there is not an abrupt change in the type of calculation used at this frequency. Rather, there is a smooth transition from complex summation to power summation that occurs. This transition takes place over a one octave interval. As an example, for an `UP TO FREQUENCY` of 1 kHz, the transition from complex to power summation starts one-half octave below 1 kHz (707 Hz) and ends one-half octave above 1 kHz (1.41 kHz). At 1 kHz the summation is 50% complex and 50% power. This balance smoothly changes over the one octave transition bandwidth. In reality, the transition from coherent to incoherent does not only happen as a function of frequency but also as a function of the propagation distance to the receiver and of the relative distance between considered sources and will depend on environmental conditions. These effects are not accounted for in EASE Focus.

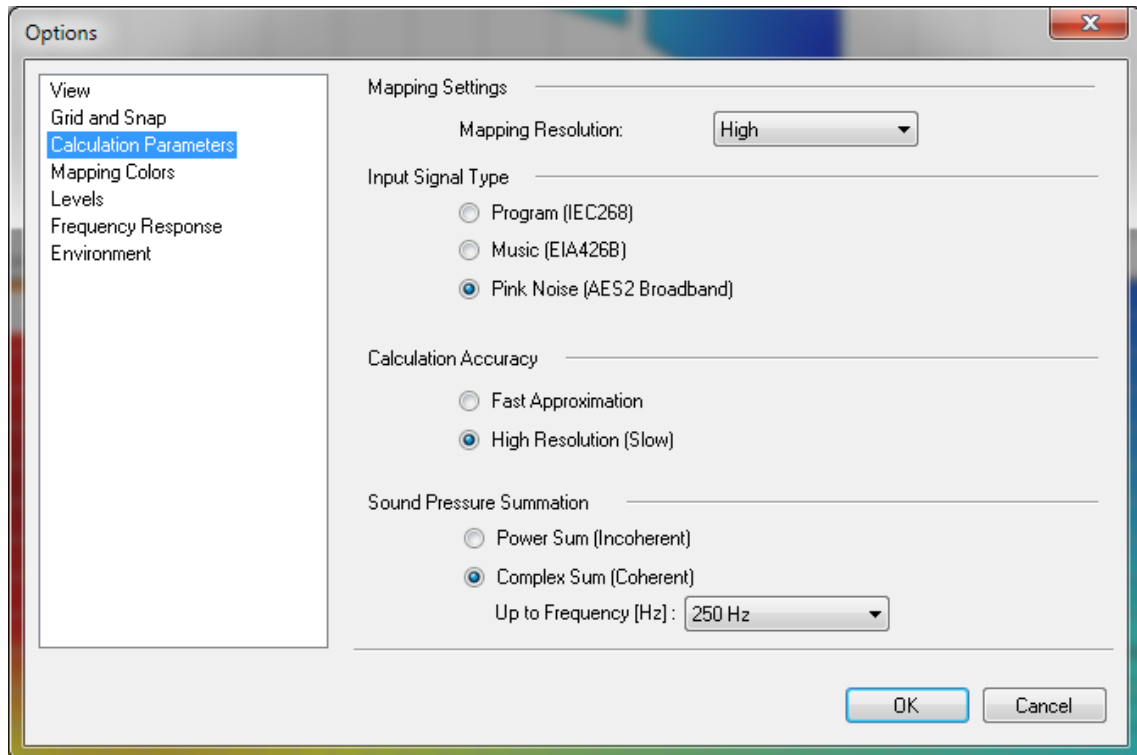

If you select the `MAPPING COLORS` page, you will be able to choose between an automatic color scale (default) or a scale constrained between values that you define. You can do this separately for SPL and Signal-to-Noise mappings (when using Extended mode §5.3), and you can even choose to invert the scale with respect to default colors.

You can also access this option page directly by clicking on the mapping scale on the right side of the Top View or of the Side View.

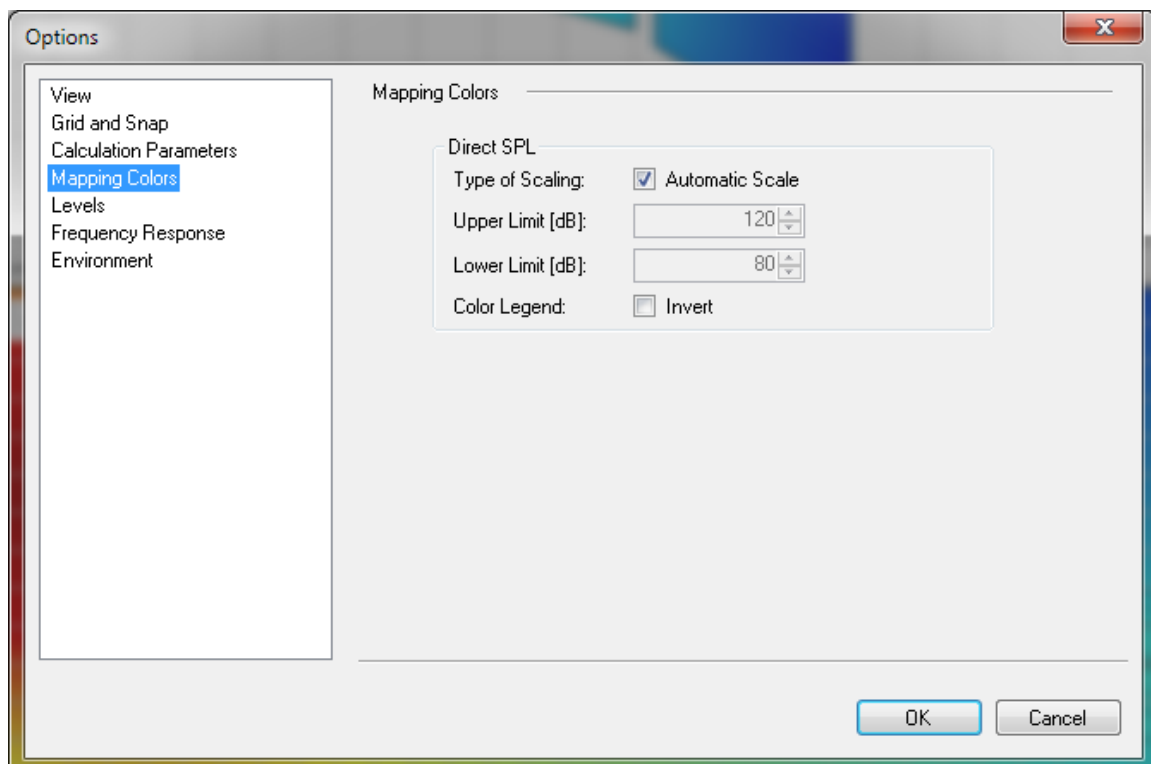

4.4. Levels

If you need to check accurate level readings along one direction, you can use the Levels window for that. It will consider exactly the same section that is used for the display in Side View, and show all level lines on Audience Areas that intersect with it. If an Audience Zone is selected (or locked in Side View), its Audience Areas are cut along the median axis; for Sound Sources, all Areas that intersect with the aiming axis will be shown. The same holds for Receivers (§4.6) and Section Planes (§6.2). Note that this information is also visible in Side View, only you do not have the Z coordinate in the Levels window, but rather a dB scale, so you can have a more accurate idea on how to interpret level lines.

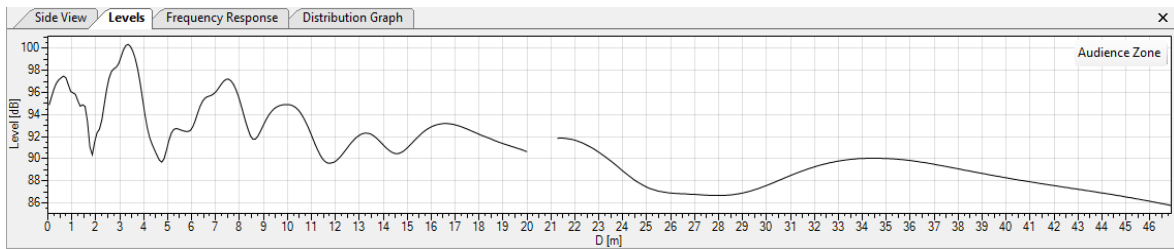

Clicking on the dB scale on the left will directly open the LEVELS page in the Option window. An alternative to that is selecting FILE | OPTION or pressing F9 and then opening the LEVELS page manually. You can choose here to have an automatic scale (default) or define a manual scale.

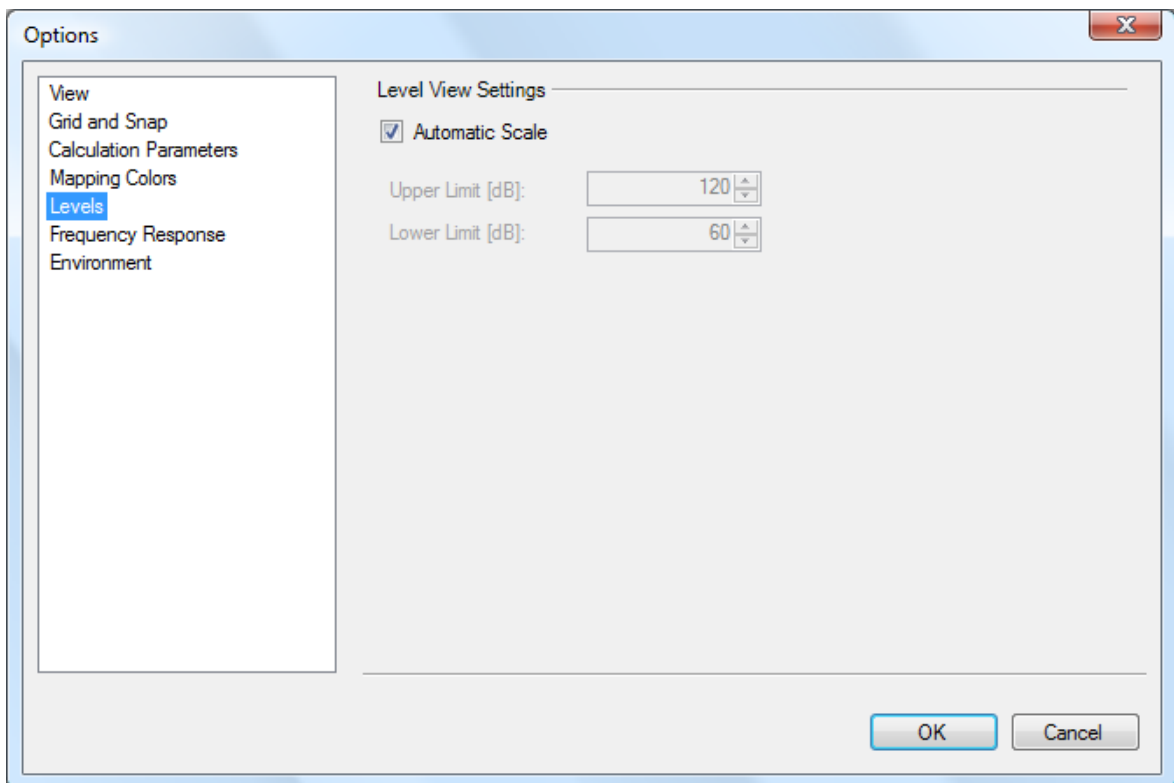

4.5. Distribution Graph

When mapping is active, the Distribution Graph window is available as a tool to check the acoustic coverage on your project. You can view statistics on pressure levels over all mapped points, and see a bar chart that

summarizes all results. The width of the bars can be adjusted. Displayed are the average SPL or S/N value, the standard deviation, information on which percentage of all calculation points has been included in the graph and the total number of points.

The distribution function is especially powerful to optimize the uniformity of SPL coverage and S/N. Select a class width of 3 dB or 6 dB to see the percentage of all mapping points within that range relative to the average. Typically, system designs try to optimize coverage in a way that, for example, 90% of the audience is within a range of +/- 6 dB.

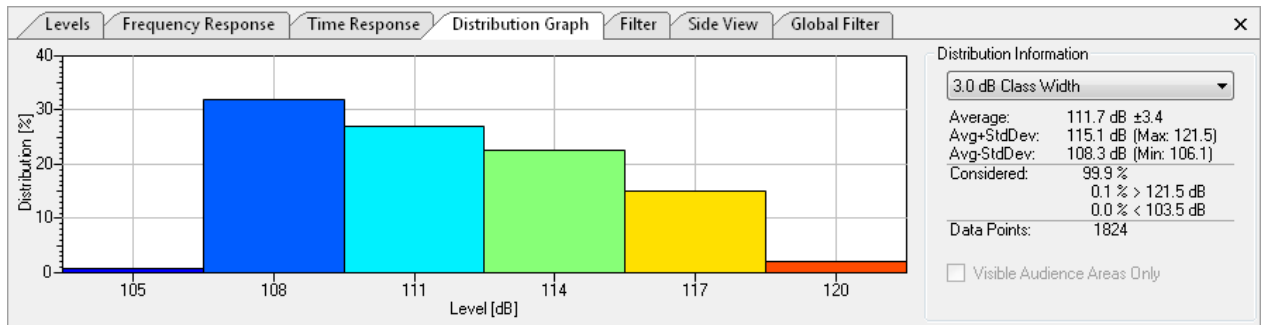

4.6. Adding Receivers

To add a Receiver, use the icon  and then simply click on the location where you would like to place it, or click and drag to adjust its viewing orientation. There are mainly two types of Receivers: anchored and unanchored (free). Anchored receivers are bound to a specific Audience Area, and move along with it; free Receivers preserve their original position independently of all other objects in the project. Anchored Receivers can be recognized from a dot on their bottom end, free Receivers from a cross.

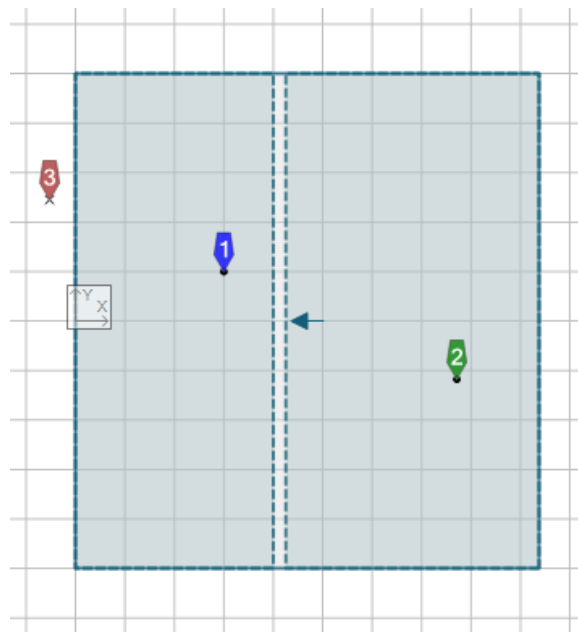

Receivers can be added both in the Top View and in the Side View, by just clicking (or dragging in Top View) after you select the toolbar button. A Receiver added or moved inside an Audience Area will be automatically anchored to that Area, and its height will be the corresponding audience ear height at that point. To add or

move a free Receiver over an Audience Area, hold the Ctrl key while performing the operation with your mouse.

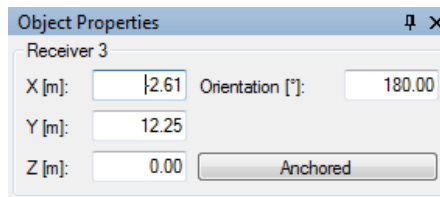

As seen for other objects, you can edit the properties of a Receiver in the Object Properties window (if it is not visible already, select the Receiver and choose `VIEW | PROPERTIES`, or alternatively right click on it in the Top View and select `PROPERTIES`, or just press F4). The properties of a Receiver consist primarily of its coordinates. You can also toggle the `ANCHORED` property, or define its orientation (corresponding to the aiming line shown in Top View): this will determine what will be displayed in the Side View when this Receiver is selected.

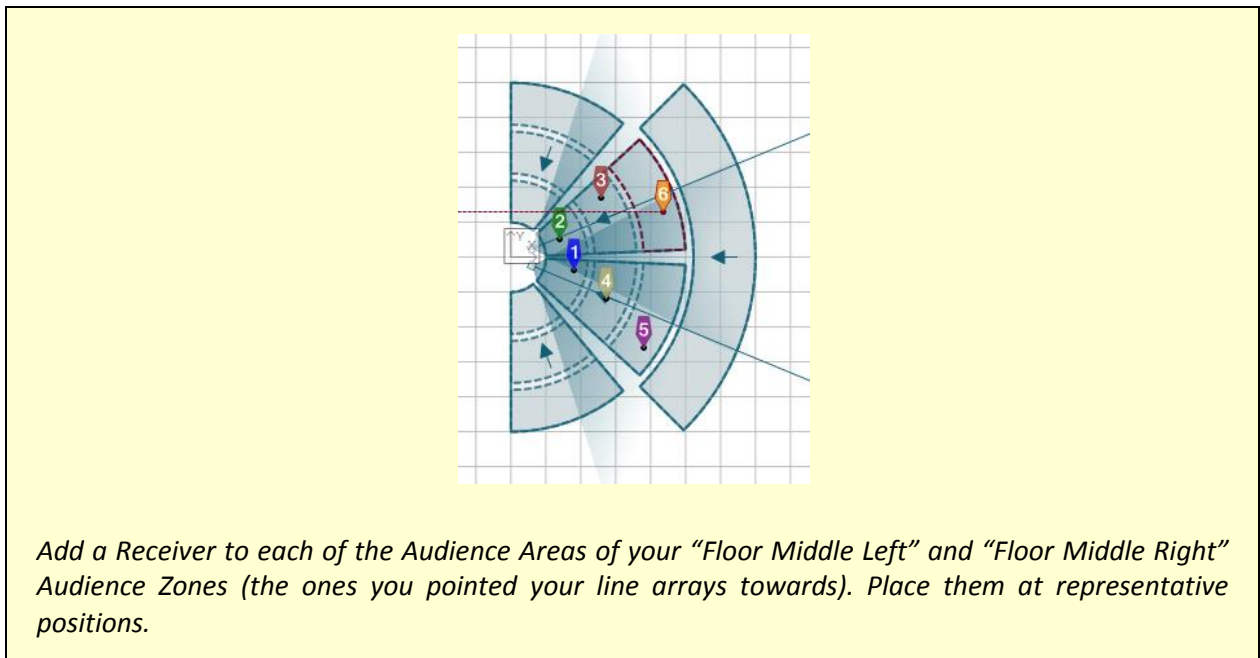

4.7. Frequency Response

The response at Receiver points can be monitored with the Frequency Response window. The type of graph (Direct SPL, A-Weighted, S/N Ratio) reflects the settings in the Mapping toolbar. The resolution will be one octave, unless you selected a mapping resolution of 1/3 octave (available in the Extended mode, see §5.3). You can use the legend in the top right of the Frequency Response window to show or hide plots for specific receivers (by right-clicking on their symbols) or to display relative values to a specific Receiver (by left-clicking on the Receiver that you want to use as a reference).

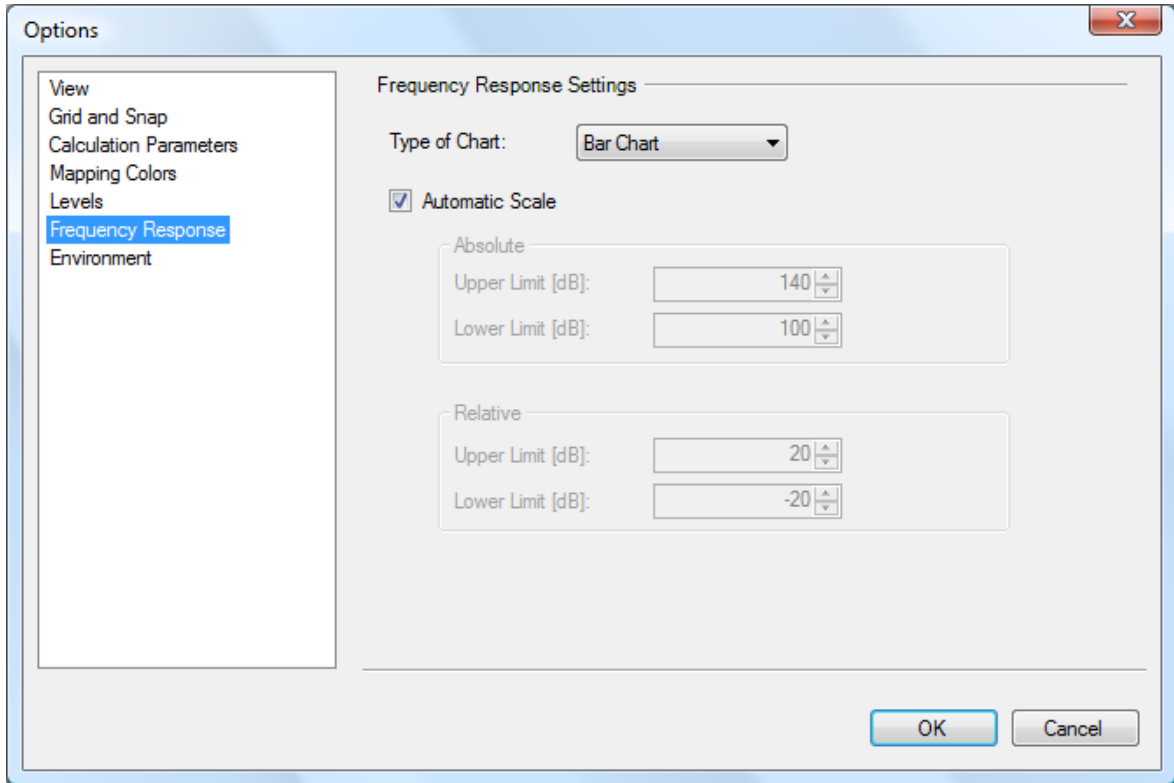

Clicking on the dB scale on the left will directly open the `FREQUENCY RESPONSE` page in the Option window. Alternatively you can select `FILE | OPTIONS` or press `F9` and then open the `FREQUENCY RESPONSE` page manually. Here you can choose between displaying an automatic scale or defining a manual scale, both for the absolute and for the relative plot.

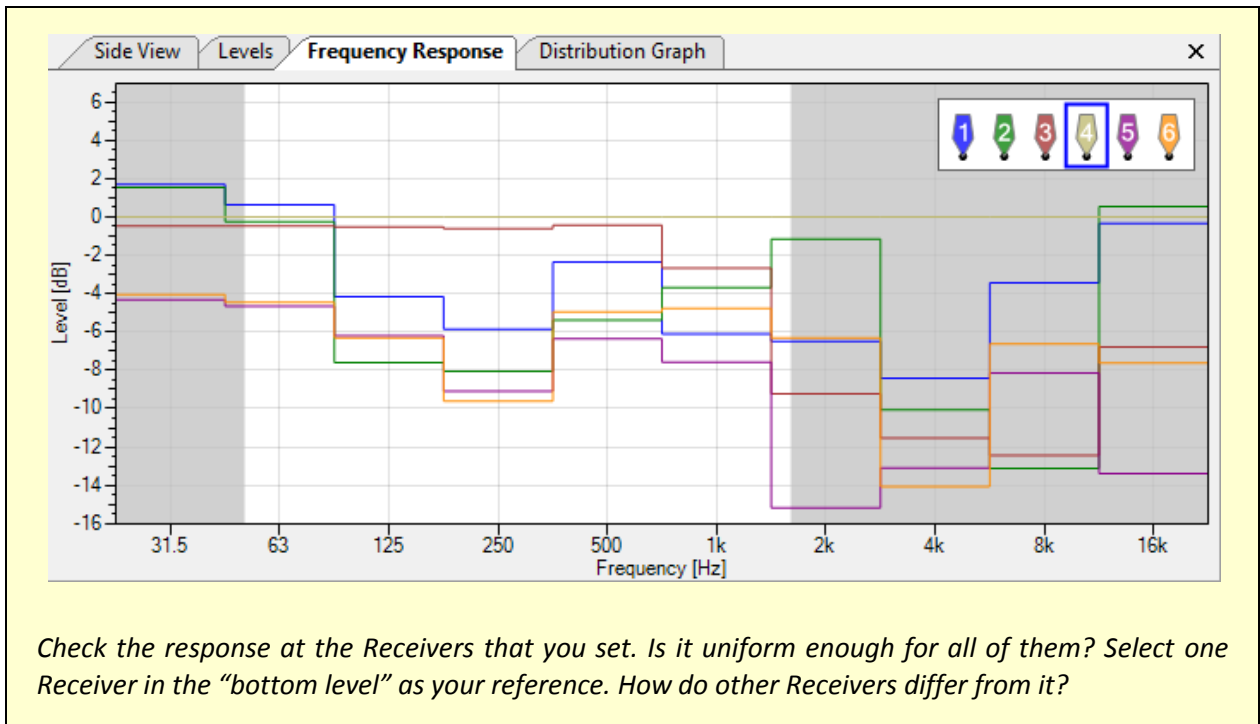

4.8. Sound Source Groups

When working on complex projects, you may often want to optimize smaller audience portions and single systems separately. If you find yourself in this situation, you will appreciate Focus’ ability to toggle every single Sound Source in your project. This can be done in the Mapping Toolbar: here you find a dropdown menu after the label **SOURCES**, listing all Sound sources in the project. The default text will be **ALL SOURCES** followed by the number of Sources in your project. To switch a Source off, click on the menu and select its name from the list. The Source that you turned off will display a black icon as shown in the figure below. If you want to switch a Source on when it is turned off, just perform the same operation again. You can switch all Sources on or off at any time by clicking on “All Sources” on top of the menu.

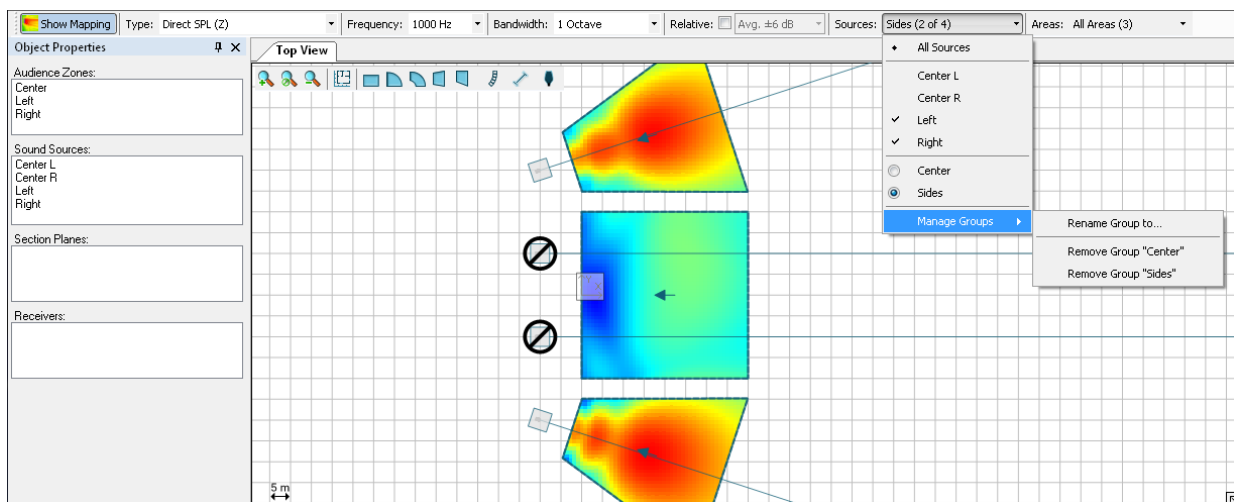

If you need to constantly switch between different source on/off combinations in your project, you want to avoid doing this operation every time: you need Sound Source groups for that. Switch all Sources off except the ones that you want to include in your group. Then, still in the **SOURCES** menu in the Mapping Toolbar, select **MANAGE GROUPS | STORE CURRENT SELECTION AS A GROUP**. You will be asked to enter a name for your new group.

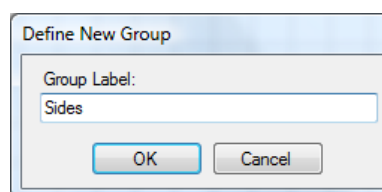

You can then recall a group at any time from the **SOURCES** menu. When a group is active, you can also rename it or delete it from the submenu **MANAGE GROUPS**.

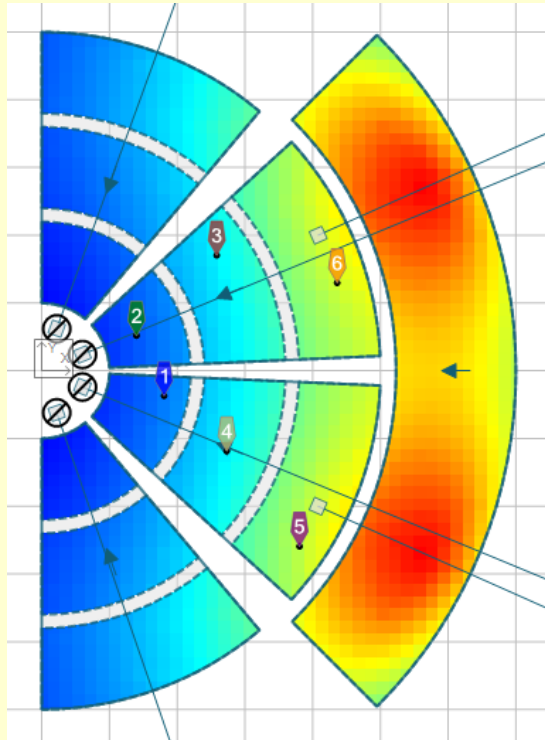

Place two Line Arrays in front of "Left" and "Right" Audience Zones, as you did in §0 for the middle Zones, and two for the balcony (see figure). Configure all new Sources. Then create a group for floor Line Arrays and a group for balcony Line Arrays.

4.9. Audience Area Groups

As explained for Sound Sources in the previous paragraph, Audience Areas can also be hidden from the mapping. This is especially useful when two Areas are partly overlapping, and one is hiding the other one’s mapping. Toggling mapping for Areas works just like for Sources: In the **AREAS** menu in the Mapping Toolbar, you can see a list of all Audience Areas divided by Audience Zone, and turn single Areas or whole Zones on and off.

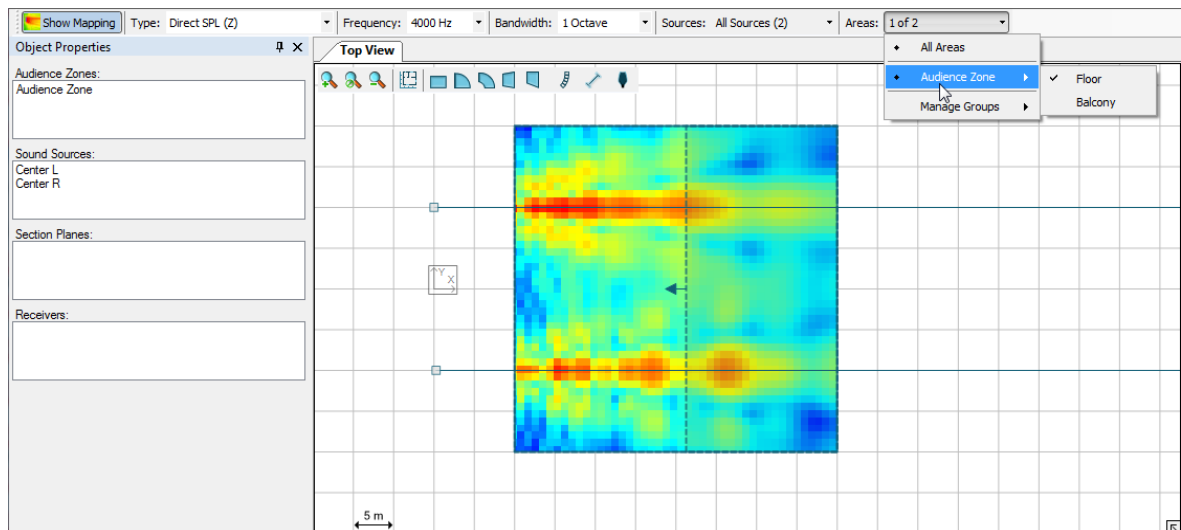

For Audience Areas you can also create groups, as already described for Sound Sources: switch on all the Areas you want to include, and select **MANAGE GROUPS | STORE CURRENT SELECTION AS A GROUP**. You can then use the submenu **MANAGE GROUPS** to rename it or delete it.

Note that you can create or edit Audience Area groups when copying Audience Areas between Zones as well (§2.6). If you want to do so, you need to perform this operation from the **COPY AREAS** button in the Object Properties window of your Audience Zone. Here you can pick one of two options: **CREATE NEW GROUPS** will make from scratch a new group for every Audience Area to be copied, including the original Area and all its copies across all Zones. If you already have one or more groups including some of the areas that you want to copy instead, and you want to include their copies in the same groups, you need to check **EXTEND EXISTING GROUPS**. You can even choose which specific groups you want to extend.

Please note that the Distribution Graph (§4.5) will continue to include hidden Audience Areas in its statistics. Mappings will also always be calculated for all Audience Areas, no matter if visible or hidden in the current view.

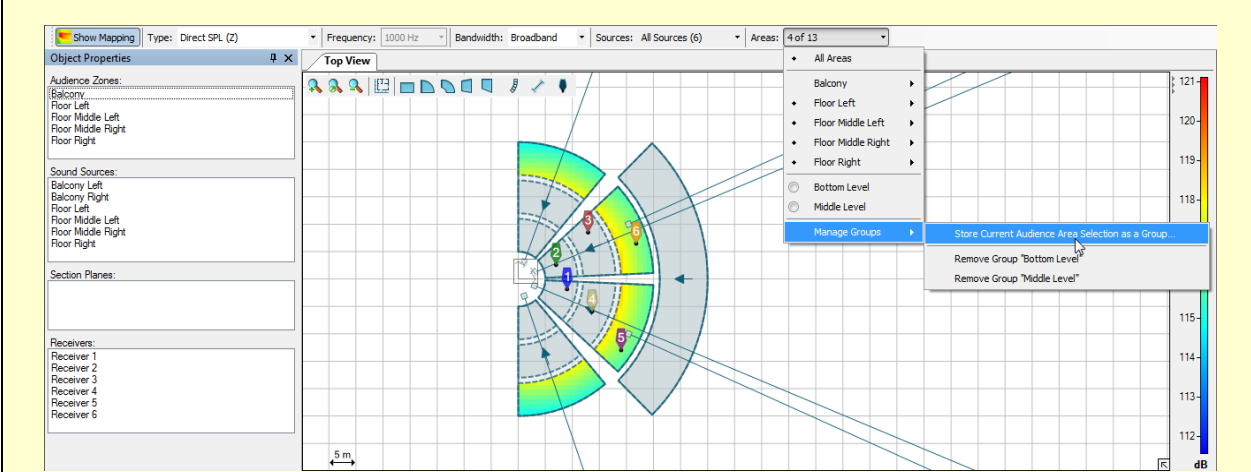

Create an Area group for every level of your amphitheater. Do this by selecting all areas one by one first.

You could have done this quicker when you copied your Audience Areas to all floor Zones of your project. If you want to try this, delete the groups you just created. Then select one of the Zones and perform the Copy Areas operation again, from the COPY AREAS button in the Object Properties window. Select all other Zones, expand the AUDIENCE AREA GROUPS panel and check CREATE NEW GROUPS, then click OK.

4.10. Exporting Pictures

Once you finish working on your project and you are satisfied with the results you have obtained, you can show them to the people you are working with or take them to the venue. One simple way to do this is by exporting pictures from windows. All EASE Focus windows that display pictures, maps or plots are able to export them to files as well: to do that, use the menu item FILE | EXPORT PICTURE. This will open a submenu with a list of all available windows: those which cannot export a valid picture are grayed out, the others are enabled. If you select one of the enabled items, a dialog will appear asking where you want to save the picture and offering different formats to choose from. Once the picture has been saved, it will be opened automatically with your default program.

Another way to export pictures is by right-clicking on them. This will open a popup menu with two options. Choosing SAVE PICTURE TO... will save it to a file, equivalently to the procedure described above. Selecting COPY PICTURE TO CLIPBOARD will store it in the Windows clipboard, so you can paste it in any software program that supports it.

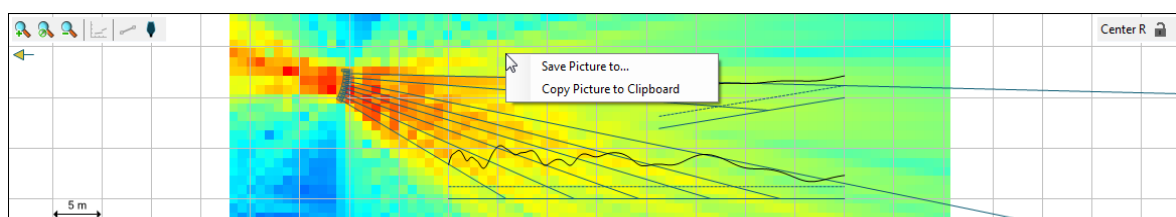

4.11. Creating Reports

The easiest way to generate an overview of your project, however, is the report feature. This can be accessed by selecting **FILE | CREATE REPORT**. A small window will be displayed asking which details you want to include in the report; then you will be asked for the location where you want to save it and which format you want to use: you can choose between PDF, which will produce a file readable with Adobe Reader or similar software and ready to print, and RTF, which you can edit with Microsoft Word or other word processors. The result is a document containing all the details from EASE Focus that you need to install your sound reinforcement system at the event location.

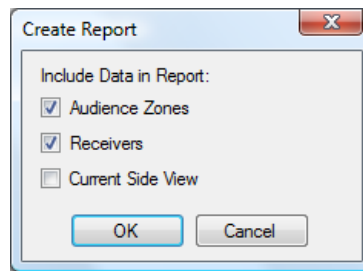

Congratulations! You now have sufficient knowledge to take full advantage of EASE Focus for your projects. You can still play around with your amphitheater project, for example adding more receivers, trying to tune your line arrays or to displace them, and generating pictures and reports. If you want to discover the advanced features in EASE Focus, you can go to chapter 6 and start with a new project. But first we suggest that you read chapter 5 to learn more about the options available in EASE Focus.

5. Options

In this chapter we will briefly examine the `OPTIONS` window. You can open it from the menu `FILE | OPTIONS` or by pressing `F9`.

In the previous chapter we have already discussed the option pages for `CALCULATION PARAMETERS` and `MAPPING COLORS` (§4.3), `LEVELS` (§4.4) and `FREQUENCY RESPONSE` (§4.7). The `TIME RESPONSE` page, available in the Extended mode (§5.3), will be discussed in §6.7.

Therefore, here we will only go into the remaining pages: `VIEW` (§5.1), `GRID AND SNAP` (§5.2), and `ENVIRONMENT` (§5.3).

5.1. View

In the `VIEW` page you can switch on and off some elements that can be displayed in the Top View, Side View and Rigging windows.

Both Top View and Side View can show rulers for both axes and an origin marker at the point $\{0, 0\}$. For the Side View you can also toggle level lines on Audience Zones; in addition, you can choose to always display the 3D case of a Sound Source in the background even when another object is selected. Leaving the option `INCLUDE AUDIENCE ZONES BEHIND SOUND SOURCE IN ITS DEFAULT VIEW` unchecked will display the selected Sound Source always on the left edge of the Side View, along with all elements in front of it; checking it will show objects behind it as well, if some exist.

Finally you can choose to show or hide the total dimensions of sound sources in the Rigging window.

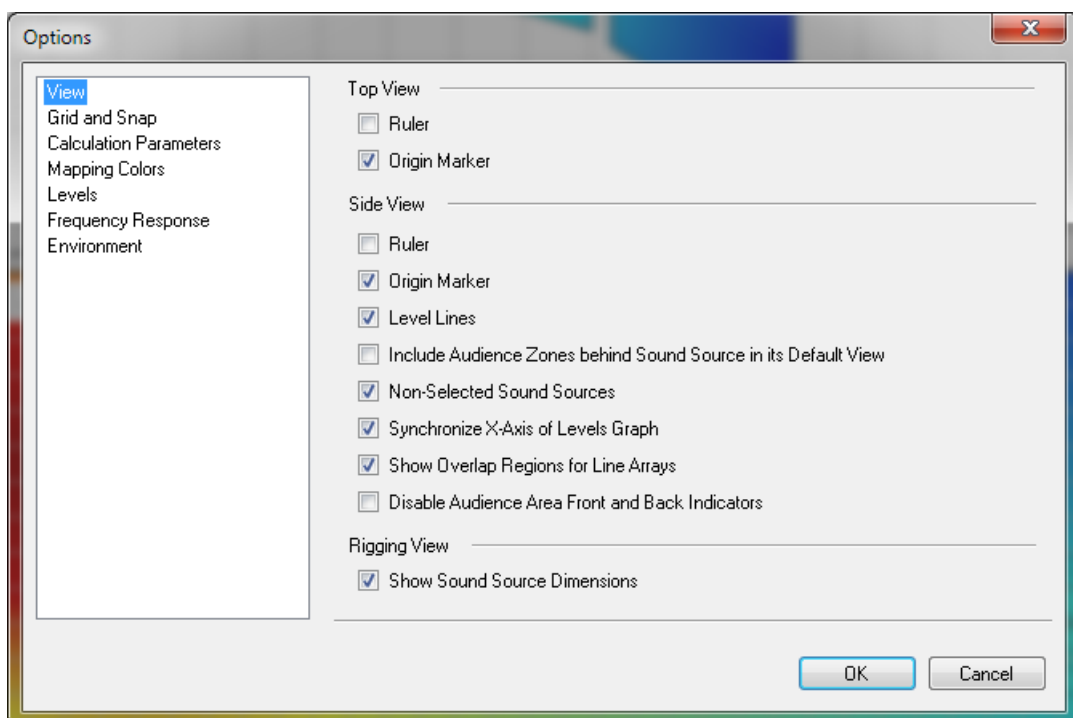

5.2. Grid and Snap

The `GRID AND SNAP` page displays options related to the grid, shown in both Top View and Side View, and to the behavior of the user interface when moving or editing objects.

There are two types of grids in EASE Focus: `FULL GRID` shows a normal grid, as is in the default settings, whereas `POINTS ONLY` displays only crossing points between grid lines, but not the lines themselves. Alternatively, the grid can be completely deactivated by choosing `NO GRID`. If a grid is visible, its size can be automatic (based on the zoom level) or manual (a fixed value entered by the user).

Snapping happens in two ways when the grid is active: `SNAP TO GRID` refers to all those actions where an object is being moved or resized, and the object or its edges automatically snap to grid lines when they are close enough; `ALIGN TO AXES` happens whenever an object is being rotated, and its edges snap to the vertical, horizontal or 45° diagonal axes. Both behaviors can be toggled for all types of objects, and their sensitivity can be set with the `SELECTION TARGET SIZE` dropdown menu.

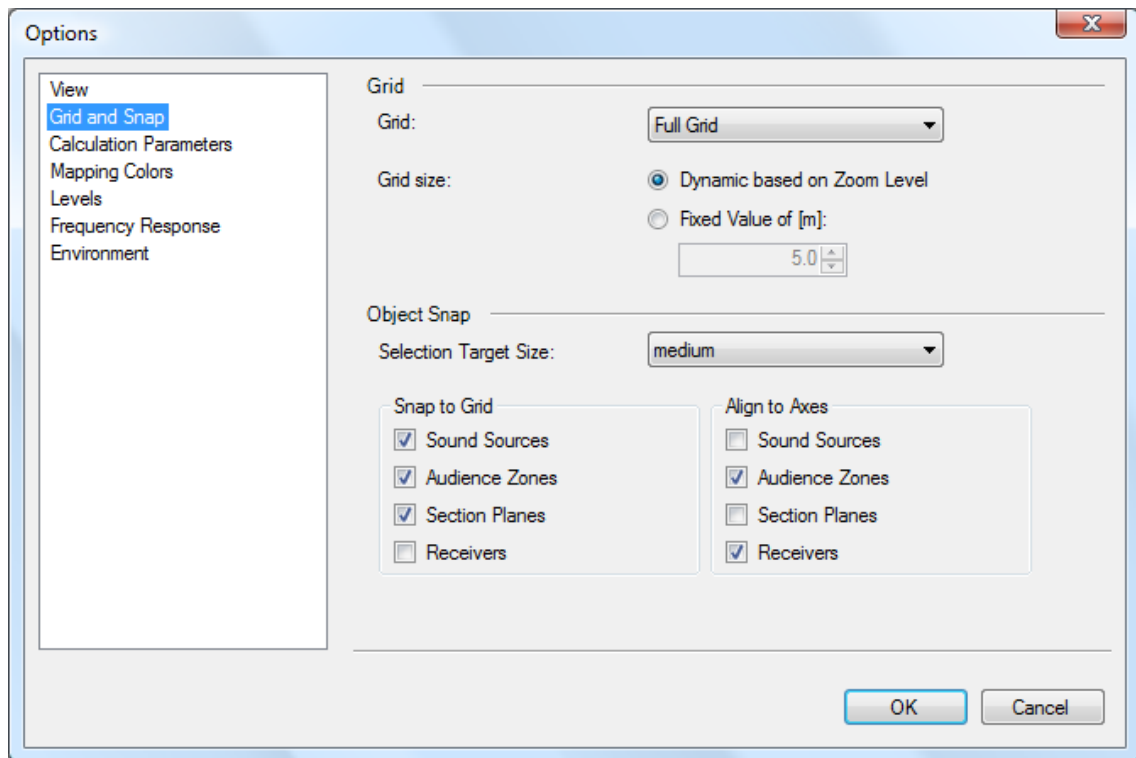

5.3. Environment

The `ENVIRONMENT` page lets you choose the language of EASE Focus (which also affects reports that you produce, §4.11) and the measurement units (meters or feet).

Here you can also switch between `STANDARD` and `EXTENDED` mode. Extended mode enables some features that you may need when working on complex projects, such as Time Response (§6.7), Signal to Noise Mappings (§6.11), Filters and Global Filter (§6.3).

The **GAIN GROUPING** feature allows the gain of multiple adjacent boxes in a line array to be linked and controlled together. This effectively incorporates the common practice of driving multiple boxes with a single amplifier channel.

The **DEFAULT GROUP SIZE** dropdown allows the default number of cabinets per group (e.g. per amplifier) to be set. This means that, whenever you insert a new line array in the project, this is the number of cabinets that will be selected for each group automatically. The number of cabinets (boxes) in a group can be changed for each array (Object Properties) without affecting the default value or the setting for other arrays.

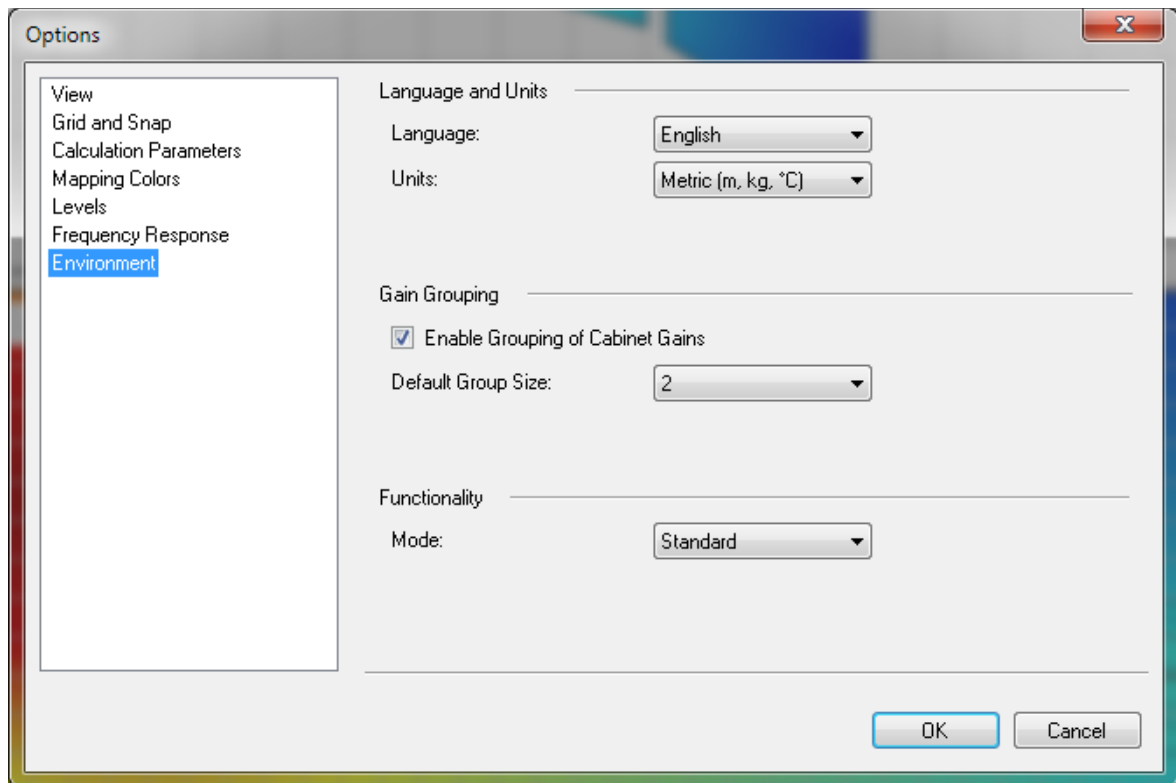

6. Advanced Features

This chapter goes into some features of EASE Focus that can be used to take full advantage of its capabilities.

6.1. Setting Layout Pictures

Sometimes you may happen to have a plan drawing or an aerial picture available for your venue. In this case you want to use the picture as a basis to draw your project on.

Click on the Layout Picture icon : a window will appear, and you will be asked for a path to load your picture from. Once you have imported the picture, you will need to drag the points A and B until they match an edge on the drawing whose length is known. Then enter the length; you can also define the shift of the image, by entering the XY-location of point A in your project, or set the opacity of the picture. When you click OK, you will be able to see the picture in Top View, and to draw your venue on top of it.

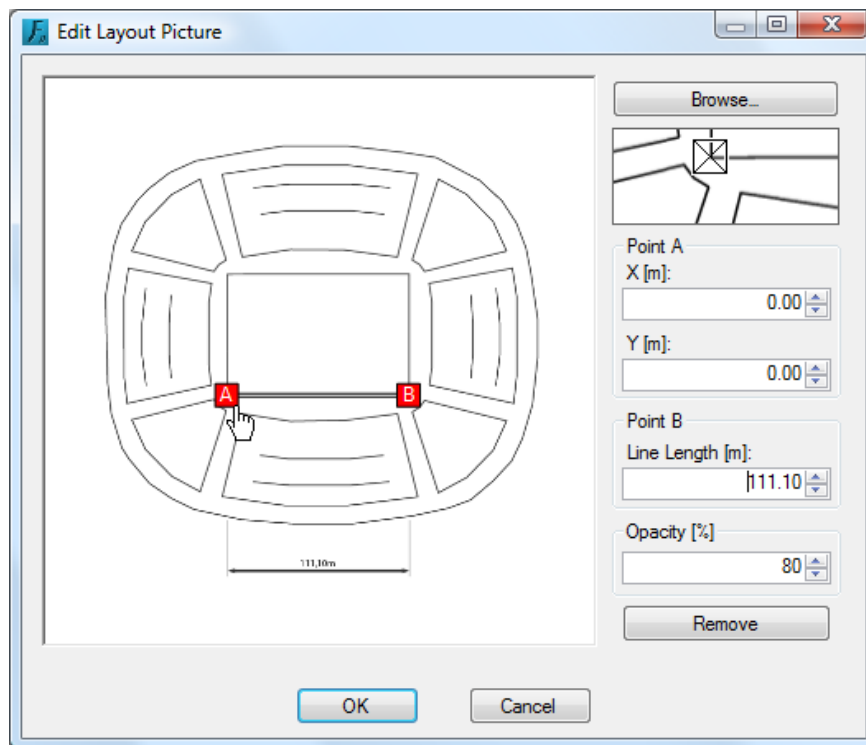

The same is possible for the Side View: in this case you can load one layout picture for each Audience Zone, by clicking on the icon  in Side View when the zone is selected. If you have a cross-section drawing of your venue, you can use it for that. In this case, you will be able to define DZ-coordinates for point A (relative to the front edge of the zone, along its central axis).

The image displays two views of a stadium model within the EASE Focus 3 software interface. The top view, titled "Top View", shows a plan view of the stadium with a grid. A horizontal dimension line indicates a width of 111,10m. A scale bar in the bottom left corner shows 20 m. The side view, titled "Side View", shows a cross-section of the stadium with a grid. A vertical dimension line on the right indicates a height of 42,79m. A scale bar in the bottom left corner shows 5 m. The software interface includes a toolbar at the top left and a menu bar at the top of the side view window with options: "Side View", "Levels", "Frequency Response", and "Distribution Graph".

Go to the main program directory of EASE Focus 3: normally this is "C:\Program Files\AFMG\EASE Focus 3" (on 32 bit systems) or "C:\Program Files (x86)\AFMG\EASE Focus 3" (on 64 bit systems), unless you entered a custom path at setup time (§1.3). Use the files that you find in the "Tutorial" subdirectory as layout pictures for a new stadium project: stadium_topview.png for the Top View, stadium_sideview_long.png and stadium_sideview_short.png for the Side View in the two dimensions. Draw Audience Zones and Areas based on it, and place Line Arrays as shown in the picture.

6.2. Adding Section Planes

Section Planes, just like other objects, can be added by clicking on the associated toolbar button  and then clicking or dragging in the Top View.

Section Planes are objects that don’t have a physical or acoustical meaning: they are only used for viewing purposes. When a Section Plane is selected, the Side View shows the corresponding section: this allows examining, for example, mappings or level lines along axes that do not relate to any other object in the project.

The starting point of the Section Plane is shown on the left in its Side View, and the end point is on the right; the default view (obtained by clicking on the `SCALE TO FIT` button in Side View) is exactly comprised between these two points, even if this may cut other elements out of the displayed section. The arrow drawn along the selected plane in Top View, just like for Audience Zones, relates to the identical arrow in Side View pointing to the left: therefore it is pointing from the end point to the starting point in Top View; the viewing perspective can be flipped by rotating the arrow, dragging the mouse handle next to its tip.

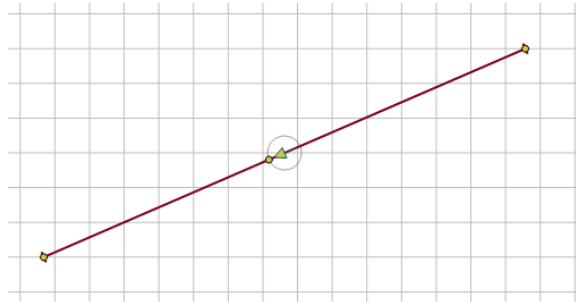

Like all other objects, Section Planes have a related Object Properties window (accessible by selecting `VIEW | OBJECT PROPERTIES` in the main menu, or right clicking on the Plane and selecting `PROPERTIES`, or hitting F4). Here you can view and edit the edge points, the length and the angle of the Section Plane.

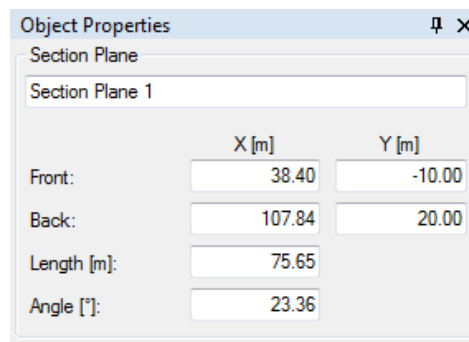

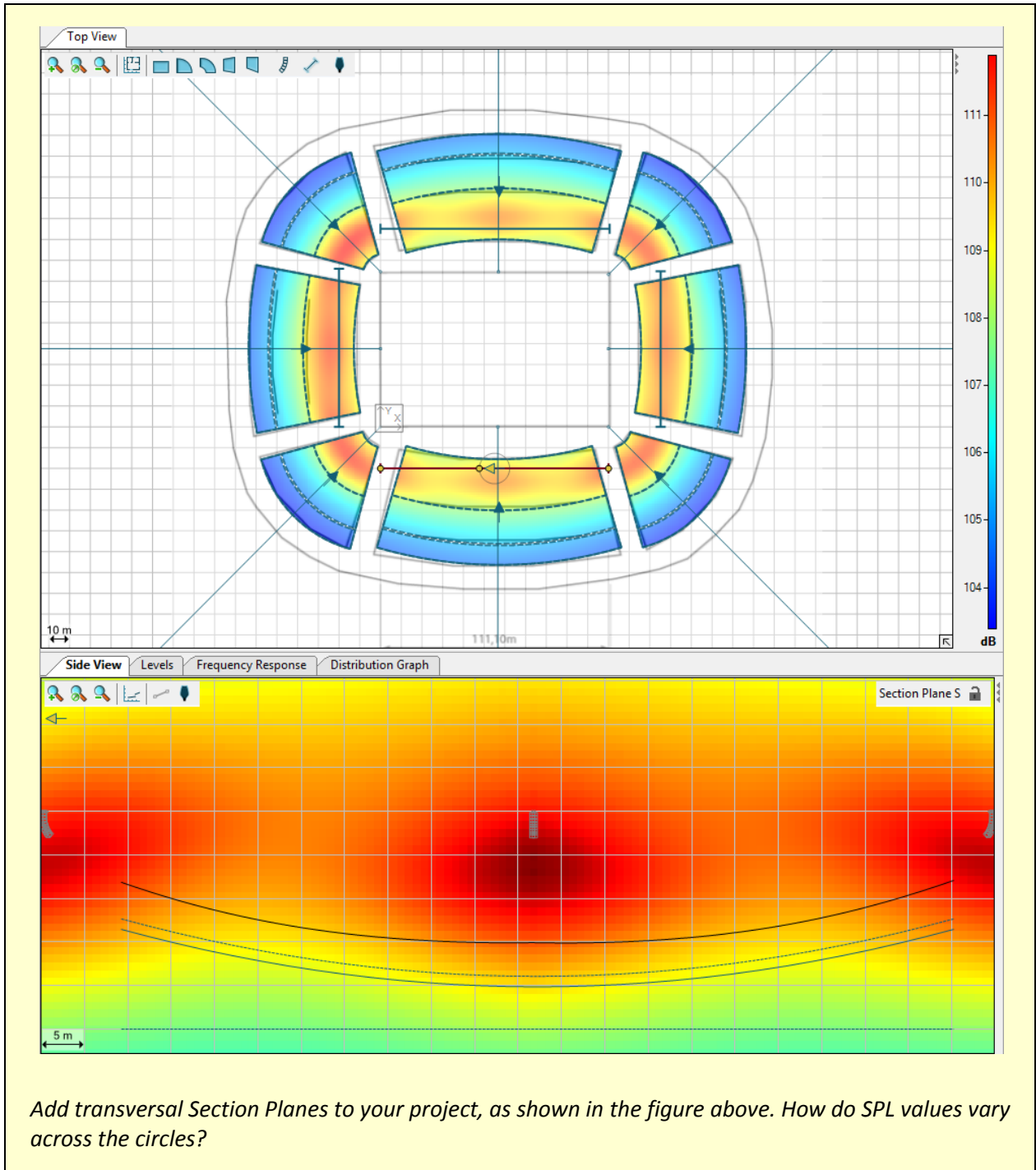

6.3. Mounting Height Based on the Lowest Point of System

The mounting height of a system can be mostly defined on its properties tab, by changing the Z field value. In the case of a line array, this height is typically referenced to a point on the top of the array frame (i.e. fly bar). For conventional loudspeakers, the reference may be the center of geometry, or the cabinet top / bottom, depending on the manufacturer’s preference when modeling the loudspeaker. There are some applications where defining the array height based on its lowest point is quite useful, however.

The sound source HEIGHT LIMITS allows this task to be performed in a quick, yet iterative, manner. In the properties tab for the sound source, specify the LOWER HEIGHT LIMIT to be allowed and click OK. The global lower limit for the project can also be specified, via the PROJECT SETTINGS window, available on the Project Properties tab.

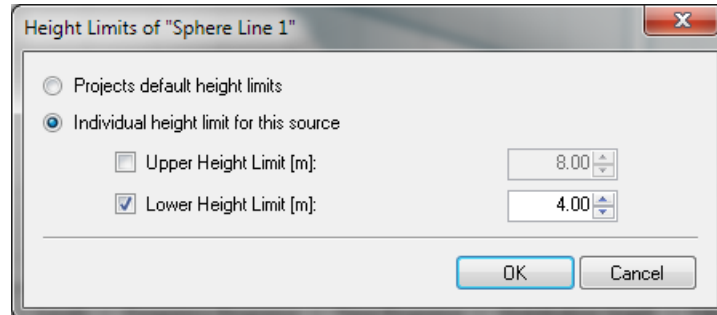

With the sound source selected in the Top View, press the shortcut keys [Ctrl + L]. This will set the mounting height of the array so that the lowest point at the bottom of the array is at the specified lower height limit. This shortcut will always take the array to the lowest height possible, based on the lower height limit specified.

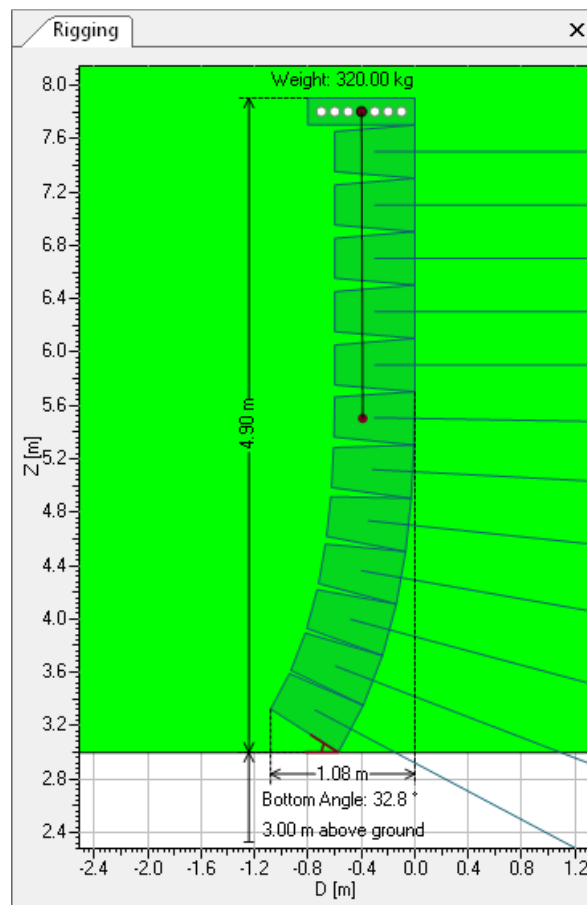

When working with a line array the splay angles may need to be adjusted after the array is relocated to the new height. The Auto-Splay routine can be used for that. Changing the splay angles might cause a slight change of the array's vertical size. This in turn causes the array lowest point to also be slightly shifted. If so, simply press [Ctrl + L] again to quickly set the system height to the lower height limit. The process of

adjusting the array height and changing its splay angles might be iterative, but usually no more than 2 iterations are needed.

The rigging picture displays an example of a 12 element line array with its height adjusted according to the lower limit of 3 meters.

Note that the height adjustment can be analogously done using the Upper Height Limit. Pressing the shortcut keys [Ctrl + U] will take the system to the highest height possible, based on the Upper Height Limit specified. If there is not a Height Limit defined for the source or the project, the corresponding shortcut will be inactive.

6.4. Filter and Global Filter

When a Sound Source is selected, a virtual filter can be applied to it: click on the Filter tab to see it (Extended mode only, see §5.3 on how to activate it). Eight individual filters are available, consisting of a high-pass filter, a low shelf, 4 peak/notch filters, a high shelf and a low pass filter.

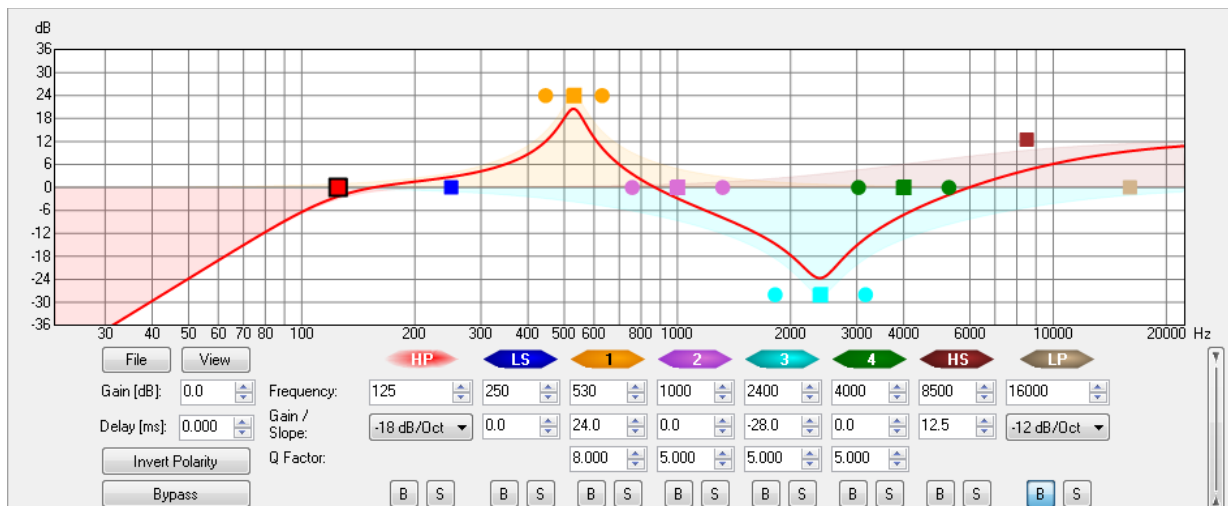

Analogously to the Filter, the Global Filter is also only available in Extended mode (see §5.3 on how to activate it). The Global Filter looks identical to the Filter, except it is not applied to a single Sound Source, that is, a Line Array or Loudspeaker/Column, but to all Line Arrays and Loudspeakers in the project.

Filters can be modified using the mouse handles in the plot or by editing filter parameters in the lower part of the screen (click on the double vertical arrow on the right to toggle the view of the parameter text boxes). Here you can also set gain and delay values as well as the polarity for the Sound Source (or for all Sources, in the case of the Global Filter). You can bypass the entire filter bank (BYPASS button on the left) or individual filters (B button below each filter); clicking on any of the S buttons you can also “solo” a particular filter and exclude all others.

Clicking on the VIEW button you can edit graphical details of the plot. With the FILE button you can import a previously saved compatible filter or export the current filter to an EASE Generic Filter Bank (.xgfb) file. This is the same format used by all AFMG software, such as EASE, EASE SpeakerLab and SysTune. You can also save only the transfer function of the filter, as an impulse response stored in one of many formats including .etm, .efr (EASERA), Wave file and more. These formats are also compatible with all AFMG software.

Note that the color symbols located above the parameter fields are highlighted depending on which filter you are adjusting at the moment. Use a right mouse click on the filter symbol to reset the associated filter setting to its default.

6.5. Filter Settings for Line Arrays

Some line arrays will let you define filter settings for their sources. In most cases you can choose to have a single input for every box or even adjust multiple inputs for each box.

If a system definition lets you define filter settings, you will see it in the Object Properties window: just beneath the POSITION & ORIENTATION frame, two buttons will appear: RIGGING and FILTER SETTINGS. Clicking on them you can switch the view between rigging settings (available for all line arrays) and filter settings, where you can define input types exploiting configurations made available by the manufacturer.

The difference between these filters and the filters specified in the Filter window of EASE Focus is that these filters are internal filters to the box (GLL), which are usually configured through an external controller, a DSP unit, or a switch on the box. The filters applied using the Filter window in Focus are a “front-end” filter for a given loudspeaker or array in a Focus project. The Global Filter, on the other hand, is a set of filters that are applied globally to all of the loudspeakers or arrays in a Focus project. This usually represents a device located right after the mixing device in the signal chain, before the signal is sent to the different line arrays.

6.6. Positive Cabinet Gain

It is possible to select positive gain values when clicking the GAIN dropdown, such as “+1”, “+2”, up to +6 dB. Since EASE Focus does not allow the input to any sound source to exceed its maximum input voltage, a positive cabinet gain value does not actually turn up that cabinet. Instead, it turns down all the other cabinets in the array by the selected amount.

As an example, changing the first cabinet gain to +3 dB corresponds to reducing the gain of all other cabinets to -3 dB. This occurs because Focus will always display the maximum output for the system. The maximum input voltage for the array is also updated accordingly. Changing the second cabinet in the array to +3 dB will not result in a further reduction in level for the other cabinets. They all remain at a reduced level of -3 dB. The second cabinet which had first been reduced by 3 dB is now at 0 dB due to the +3 dB being selected for it.

It should be noted that the XGLC export to EASE (from the RMB menu of the system) will not work well when using positive gains, as EASE does not yet support positive cabinet gains. There will be no error in the calculations but the GUI will not update properly to reflect the positive values. The same applies to the GLL Viewer and to EASE SpeakerLab. If positive cabinet gains are exported a warning is shown to inform the user.

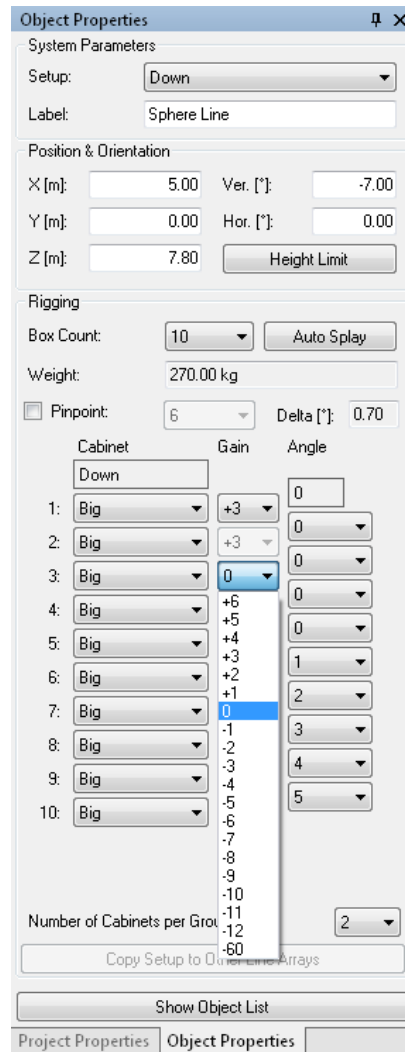

6.7. Time Response

For each Receiver, the time of arrival and direct SPL of every Sound Source can be viewed in the Time Response window (Extended mode only, see §5.3 on how to activate it). Click on a Receiver in the list in the top right of the Time Response window to see the plot for that Receiver. This view may be useful if you want to align delays for different Sound Sources. To set a delay for a specific Sound Source, select it and open the Filter window.

Just like in the real world, in the simulation domain the signal delay can also be optimal only for a single spot. When deriving delay values from the time response graph, make sure that you consider several listening locations which are representative of the whole audience area. Also note that the audibility of individual sources will depend on their arrival time and level relative to each other. To investigate typical masking effects in the time and frequency domain please use the advanced acoustic modeling software EASE instead. The Time Response function in EASE Focus can only provide some approximate answers.

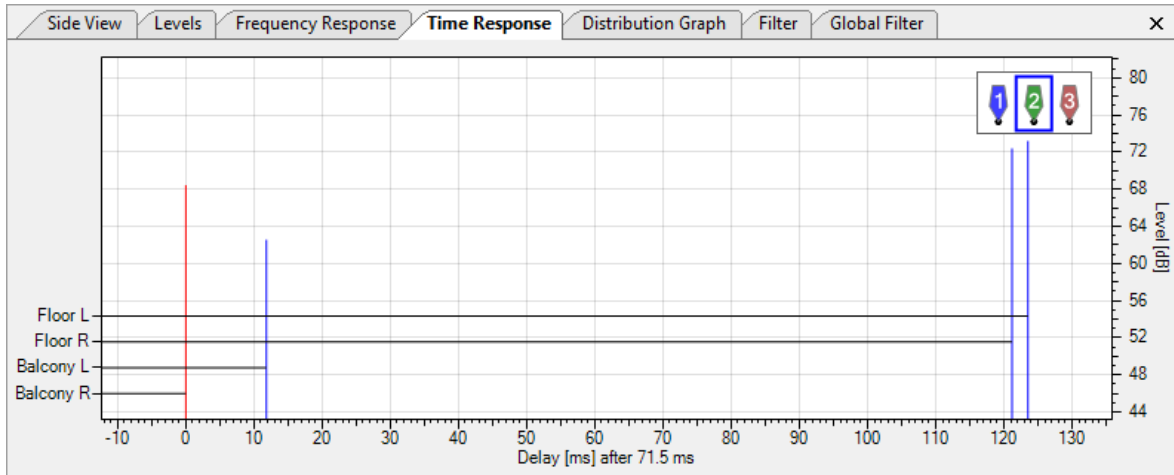

Clicking on the time scale or on the dB scale, you can access the **TIME RESPONSE** page in the Options window (alternatively, you can reach it by selecting **FILE | OPTIONS** or pressing **F9** and then selecting the item manually). Here you can choose between an automatic scale and a manual one, where you can pick the limits of the dB scale and the time span.

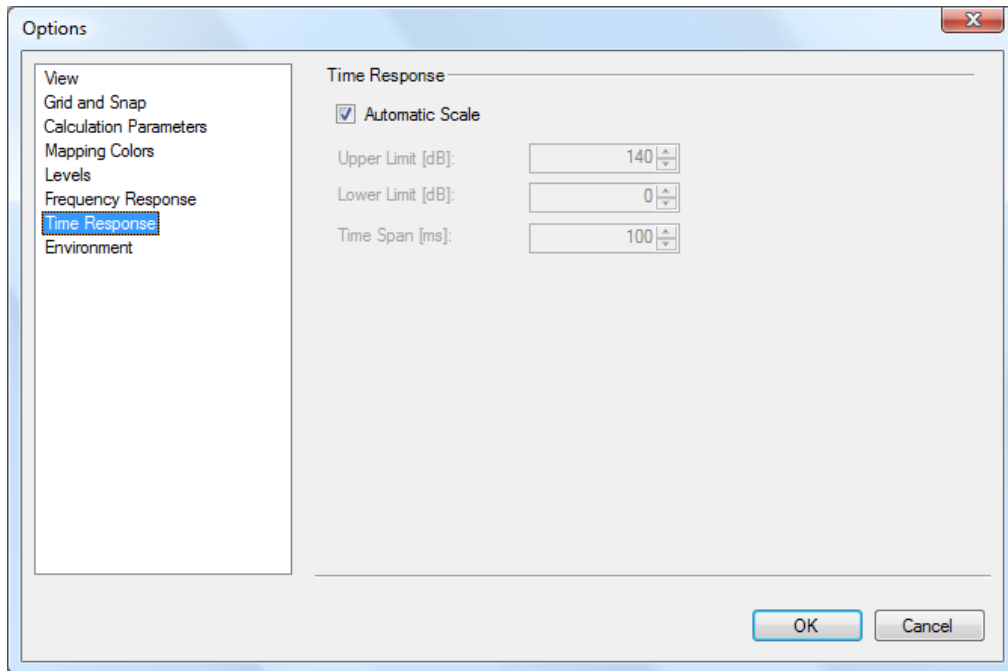

6.8. Coverage Optimization with AFMG FIRmaker

Please note that the FIRmaker functions in EASE Focus are not generally available for any loudspeaker or line array. They require a separate license:

- FIRmaker optimization can be simulated with any line array GLL that is authorized for EASE Focus 3 and for FIRmaker. Normally the loudspeaker manufacturer acquires the FIRmaker license from AFMG in order to include it with the GLL.
- Resulting FIR coefficients can only be exported for a line array GLL if a FIRmaker generator license is installed on the computer as well. A FIRmaker generator license can be received from the loudspeaker manufacturer that has provided the GLL.

The FIRmaker functionality can be accessed in the Object Properties window of the selected Sound Source. For a licensed GLL a new `FIRMAKER OPTIMIZATION` frame will be displayed.

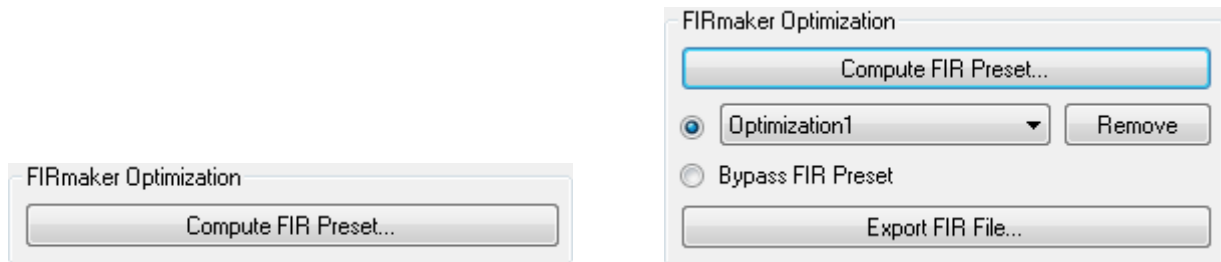

Pressing the button `COMPUTE FIR PRESET...` will open the FIRmaker FIR Filter Optimization window which is used to generate new sets of FIR filters. The presets that have already been calculated are displayed in the drop-down list below the button. Selecting any entry from the list will enable the corresponding set of FIR filters for the simulation. The `REMOVE` button can be used to discard FIR presets that are not needed anymore. Switch to `BYPASS FIR PRESET` to disable FIR filters for the simulation. The `EXPORT FIR FILE...` button will only be accessible if a FIRmaker generator license has been activated on the computer. It allows generating and saving FIR filter files for the currently selected FIR preset. These files can then be loaded into DSP control software or into a digitally controlled loudspeaker. A FIRmaker generator license is also needed to transfer FIR data directly to supported DSP control software.

Press `COMPUTE FIR PRESET...` in order to access the FIRmaker optimization functionality.

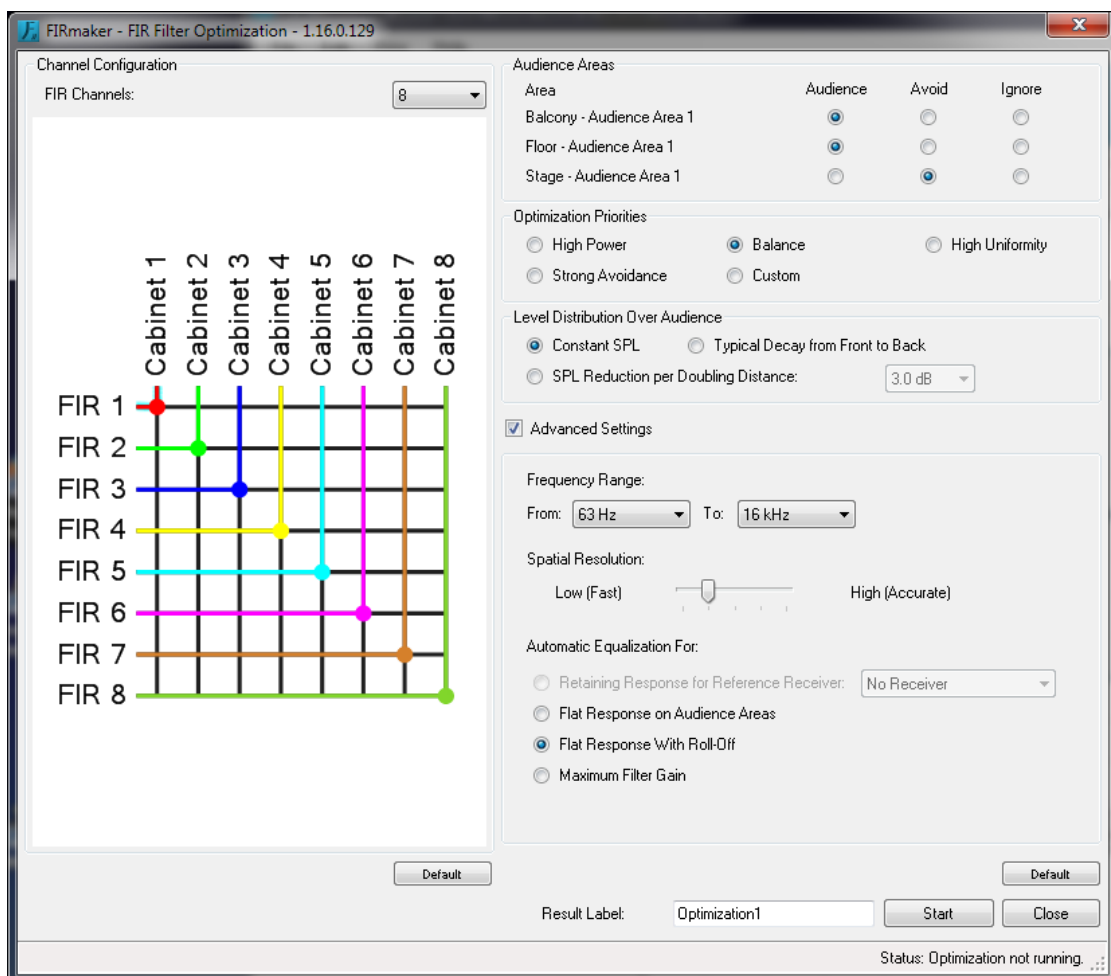

The following settings can be adjusted for the calculation of optimal FIR filters:

- **CHANNEL CONFIGURATION:** Select the number of FIR channels (DSP channels) that you would like to use for the line array. The maximum value is the total number of input channels of all cabinets of the array. Notice that optimization and beam-steering capabilities relate to the number of FIR channels. A higher channel count will generally increase the control of the radiated sound field and improve the result accordingly.

In order to group inputs or cabinets, set the nodes of the matrix by clicking with the left mouse button. To define multiple nodes quickly you can also keep the Shift key pressed while dragging the mouse. Inputs or cabinets that are not connected to a FIR channel will not radiate sound in the model. To disconnect an input from a FIR channel, press the corresponding node with the right mouse button.
- **AUDIENCE AREAS:** For each Audience Area in the project you can select if it should be optimized for high SPL and/or uniform SPL (**AUDIENCE**), if sound radiation into the direction of the area should be suppressed (**AVOID**), or if the area should be ignored during the optimization (**IGNORE**), that is, treated as if it was not there.
- **OPTIMIZATION PRIORITIES:** This setting allows defining the weights of maximizing the achievable output SPL of the loudspeaker system and of optimizing the SPL coverage relative to each other. Notice that the effect of this setting depends on frequency to some extent.

Use the **CUSTOM** selection to open an advanced control section that allows defining the relative weights in greater detail. In particular the **EFFICIENCY** slider suppresses radiation into directions where no audience is located. The **AVOIDANCE** slider allows increasing or decreasing the importance of avoided areas during the optimization. Both weights will affect the optimization for uniformity and/or high SPL.
- **LEVEL DISTRIBUTION OVER AUDIENCE:** This function allows defining a target response curve as SPL over distance relative to the location of the sound source. The setting **CONSTANT SPL** equates to a homogeneous pressure distribution over the entire audience. The **TYPICAL DECAY FROM FRONT TO BACK** is defined as an average level reduction of 4.5 dB per doubling distance. A setting of 6.0 dB relates to a target decay of SPL by 6 dB per doubling distance.
- **ADVANCED SETTINGS:** This opens a section with controls that are not needed for typical application scenarios.
- **FREQUENCY RANGE:** These settings define which frequency bands will be used by FIRmaker optimization. In most cases broadband optimization from 63 Hz to 16 kHz will be the preferred choice.

Note that the performance of FIRmaker is limited in the low-frequency range (≤ 200 Hz) due to the simulation accuracy and the FIR tap resolution. In the high-frequency range (≥ 8 kHz) FIRmaker results may be limited in practice by mechanical inaccuracies as well as decorrelation effects along the propagation path due to environmental conditions.

In this software version, for frequencies outside the optimization range, FIRmaker will extrapolate the FIR filter with a constant value for magnitude and phase. In any case, a low-pass filter is added at about 18 kHz.
- **SPATIAL RESOLUTION:** The FIRmaker process involves computing and optimizing transfer functions at many locations along the axis of the array. This setting controls the density of these points. Select a low density for long throw distances or short computation times. Select a high resolution for small spaces or very precise results.

Please be careful whenever using very high resolutions, since calculation time and memory consumption might be increased considerably for large venues.
- **AUTOMATIC EQUALIZATION FOR:** Use this adjustment to let FIRmaker equalize the average frequency response of the audience to a flat curve (**FLAT FREQUENCY RESPONSE**) or maximize the filter gain in each frequency band (**MAXIMUM FILTER GAIN**). The default setting is **FLAT RESPONSE WITH ROLL-OFF** which uses a target curve that is a flat frequency response with a 4th order Butterworth high-

pass at 125 Hz and an 8th order Butterworth low-pass at 8 kHz. This setting allows for comparably high levels while achieving a flat response curve for the major part of the audio bandwidth.

Note that applying global equalization (FLAT...) usually leads to a comparably low output SPL because the loudspeaker array is limited by its most sensitive frequency band. Note also that this setting is not part of the optimization itself but of the post-processing. This setting will not change the coverage and spectral consistency but only the overall frequency response of the system.

- **RESULT LABEL:** Enter a short label to be used for this optimization run.
- **START:** Starts the optimization and shows the current progress. After the calculation run is finished the window will close automatically and the result will be applied to the current line array.

The **AUTOMATIC EQUALIZATION FOR:** allows another option which should be explained in a bit more detail. For this option FIRmaker allows selecting a reference receiver. The frequency response at the receiver’s location will be used to determine the equalization of the FIR filters. The EQ will be chosen in such a way that the frequency response at the reference receiver does not change when switching between the FIR Preset and Bypass.

This new feature has several important advantages:

- FIRmaker will not change the sound at the reference location (at least with respect to frequency response). This should make listening tests easier and the system will sound more “natural” as the spectral properties of the array are maintained but only its spatial radiation pattern is adapted.
- One can use FIRmaker to make the sound at other positions of the venue more similar to the reference position (e.g. to the FOH location) when optimizing for spatial uniformity
- The absolute frequency response included in the GLL data is not part of the FIR results anymore. Quite a few GLL files are not calibrated identically to the systems in reality so this is very helpful in order to not introduce artificial boosts or cuts somewhere in the frequency domain due to an outdated EQ in the GLL.

The feature can be found in the “Advanced Settings” of the FIRmaker Optimization window, for FIRmaker licensed systems only.

Under **AUTOMATIC EQUALIZATION FOR:** select **RETAINING RESPONSE FOR REFERENCE RECEIVER:** then choose the desired receiver from the drop down on its right. Press OK and the FIR filters for the array will be optimized to match the frequency response at that receiver location.

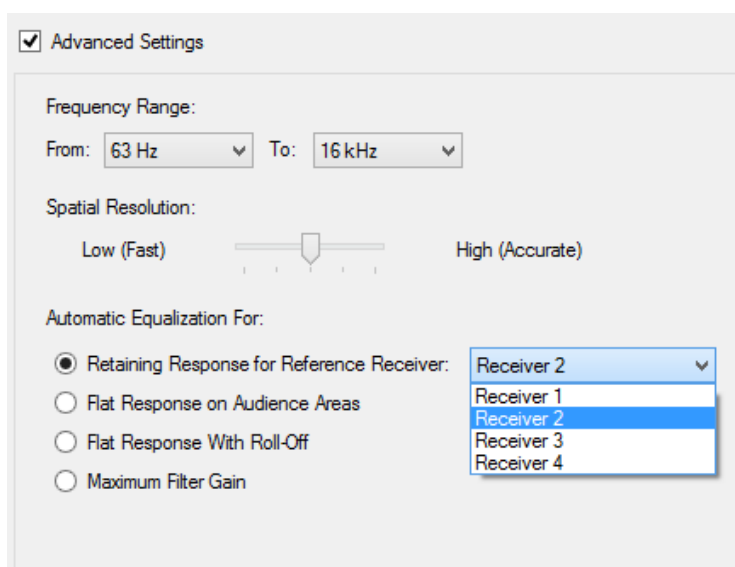

Please note that although a good match is predictable with respect to the frequency response curve, a broadband level reduction might still occur, as it’s naturally dependent on the optimization priorities defined by the user. Also, as already expected for the FIRmaker optimizations in general, the results will of course depend on the array size (especially for the low frequency region), the number of FIR channels, the spatial resolution selected, the initial setup and positioning for the system, etc.

The reference receiver is remembered with other FIRmaker settings. But notice that if the receiver of a previous optimization run is deleted, the FIRmaker window will show the first receiver in the list instead. Also it does not care about remembering the actual 3D location of the receiver.

Warning: Please note that this technical description is given on the general level. In some cases or for a particular system or setup, FIRmaker may not achieve the expected results at first glance. Please contact the corresponding loudspeaker manufacturer for recommended settings and for limitations that apply to FIRmaker functions when used for a particular product.

Select `EXPORT FIR FILE...` in order to generate a set of FIR coefficients and store them in files.

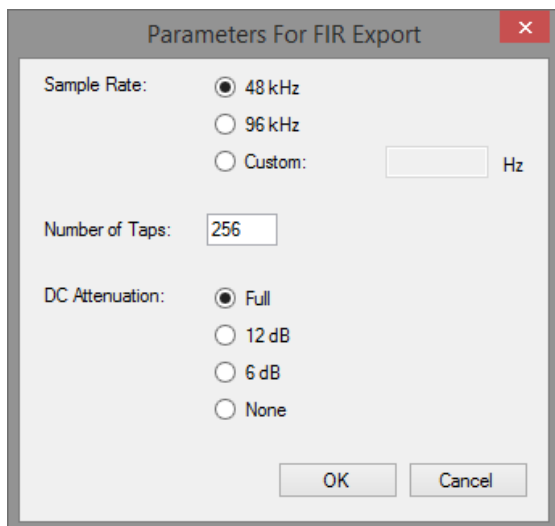

In this dialog window, the `SAMPLE RATE` for the output files can be defined using the 48 kHz or 96 kHz default values or by entering a user-defined sample rate in the `CUSTOM` field. In general, this value should be a supported sample rate of the target DSP platform. Enter the number of FIR coefficients to be generated in the `NUMBER OF TAPS` text field. It is recommended to work with at least 256 coefficients, but preferably with about 500 to 1000. Please verify your DSP specifications for more information on the number of taps that are supported.

The `DC ATTENUATION` setting helps to control the amount of artificial low frequency roll-off within the FIR filters. This affects both exported filter coefficients as well as when transmitting data directly to a DSP (e.g. Lab.gruppen Lake Controller or Powersoft Armonia).

For relatively low FIR resolutions (i.e. less than 512) the first non-DC frequency bin is around 150-250 Hz. This can usually lead to a large low frequency cut if the DC component is set to zero before exporting the FIR. Keeping the extrapolated FIR value (and not attenuating the DC value) may lead to some artifacts introduced by the windowing process. However, the probability for this to happen is greatly reduced when using receiver target curves as well as for the options Flat Response With Roll-Off and Maximum Filter Gain since they usually cause a low frequency roll-off in the filters anyway.

Press **OK** to open a file dialog that allows saving FIR filter files to a destination folder. Select the file format that is desired from the following:

- CSV files, Single Column (*.csv)
- CSV files, Single Row (*.csv)
- Text Files [SDA] (*.etx)
- Four Audio HD2 Files (*.xml)
- Four Audio HD24 Files Repeating Each Filter Twice (*.xml)

Then press **SAVE** to create the FIR files. Notice that for CSV and ETX files FIRmaker will generate a separate FIR filter file for each FIR channel of the routing matrix defined earlier. Again, this option will not be available if the PC is not licensed, i.e. if a FIRmaker generator license is not installed for the selected Sound Source.

EASE Focus also supports direct data transfer to DSP control software. Select **TRANSFER FIR FILTERS...** from the **FILE** menu in order to send the currently active FIR filters to third-party software. Make sure that the software is already running and ready to receive the information. Before transmitting the data, EASE Focus will ask you to confirm the **DC ATTENUATION** settings as explained above. Other settings such as sample rate and tap count do not have to be entered. EASE Focus will request them directly from the receiving software. A confirmation message will be shown after the transfer was completed successfully.

6.9. Exporting Line Array Configuration Data to EASE

Optimizing the mechanical and electronic configuration of a line array can be time-consuming. Particularly when considering room acoustic aspects or an in-depth analysis of the sound system design is needed, it will be interesting to simulate the sound system built in EASE Focus in EASE, as well. This process can be simplified by saving the configuration of a sound source in a GLL configuration file (*.xlgc) and loading it in EASE.

To do so, first select a Sound Source in EASE Focus. Then open the context menu using the right mouse button. From the menu, select **SAVE CONFIGURATION FILE...** in order to store the configuration data on your hard disk. In EASE, you can load the same data using the **IMPORT** command in the GLL Configuration window.

6.10. Moving the Origin

If you have been working on your project for a while, and then would like to change your reference system without having to displace all objects inside it, you can move the origin instead. Just right click on the point where you would like to place it in the Top View, and select **MOVE ORIGIN HERE:** a window will appear, asking where you want to place the new origin exactly, and the default location will be the point where you clicked. Clicking **OK** will execute the change.

Alternatively, you can perform the same operation by selecting **EDIT | MOVE ORIGIN** in the main menu.

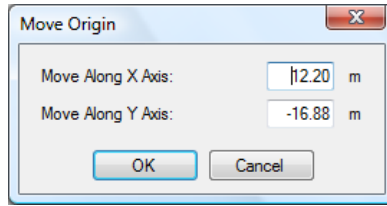

6.11. Noise Settings

If you have activated the Extended mode (see §5.3), in the Project Properties window (§2.1) you will see a `NOISE SETTINGS` button at the bottom, next to the `PROJECT SETTINGS` button. Clicking it will open the Edit Noise Levels window, where you can define noise levels for broadband, per octave or per one-third octave. You can even import noise level files in the EASE format, or export levels that you have just defined.

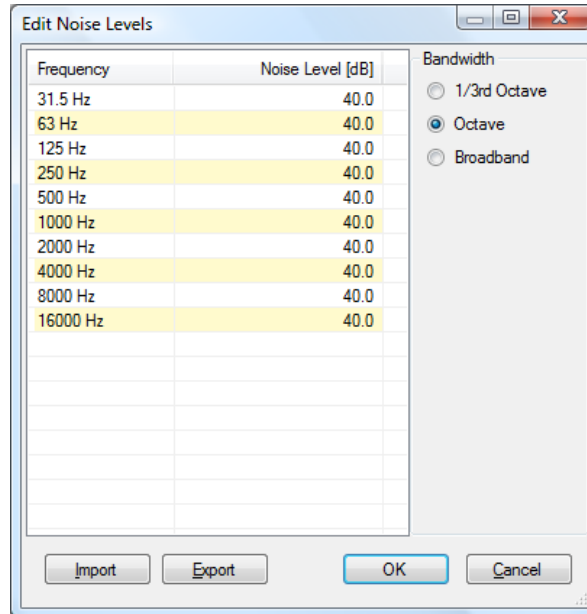

Once you have defined the noise levels, it is possible to view S/N Ratio mappings. These can be selected in the Mapping Toolbar, as an alternative to non-weighted SPL mappings and A-weighted mappings (§4.1).

7. References

Find below some articles and textbooks for further reading.

- [1] EASE, acoustic modeling software, <http://afmg.eu>.
- [2] S. Feistel, W. Ahnert, *The Significance of Phase Data for the Acoustic Prediction of Combinations of Sound Sources*, 119th AES, October 2005, convention paper 6632.
- [3] S. Feistel, W. Ahnert, *Modeling of Loudspeaker Systems Using High-Resolution Data*, J. Audio Eng. Soc., vol. 55, pp. 571-597 (2007 July/August).
- [4] S. Feistel, A. Thompson, W. Ahnert, *Methods and Limitations of Line Source Simulation*, J. Audio Eng. Soc., vol. 57, pp. 379-402 (2009 June).
- [5] S. Feistel, M. Sempf, K. Köhler, H. Schmalle, *Adapting Loudspeaker Array Radiation to the Venue using Numerical Optimization of FIR Filters*, 135th AES, October 2013, convention paper 8937.
- [6] W. Ahnert, F. Steffen, *Sound Reinforcement Engineering*, 1st ed. (E & FN Spon, London, 1999).
- [7] L. Kinsler, A. Frey, A. Coppens, and J. Sanders, *Fundamentals of Acoustics*, 4th ed. (Wiley, New York, 2000).
- [8] EASERA, acoustic measurement software, <http://afmg.eu>.