

Development of a Friction Pendulum Bearing Base Isolation System for Earthquake Engineering Education

Nikolay Kravchuk⁽¹⁾, Ryan Colquhoun⁽¹⁾, and Ali Porbaha⁽²⁾

California State University, Sacramento, CA

Abstract

Base isolation systems have become a significant element of a structural system to enhance reliability during an earthquake. One type of base isolation system is Friction Pendulum Bearings in which the superstructure is isolated from the foundation using specially designed concave surfaces and bearings to allow sway under its own natural period during the seismic events. This study presents development of a base isolation system to physically demonstrate the concept of Friction Pendulum in the laboratory for earthquake engineering education. The responses of a single degree of freedom system with and without base isolation are measured simultaneously and compared for free and forced vibrations using the accelerometers attached to the top of the model structures. The results showed that the maximum acceleration experienced by the structure was 0.23g and 0.57g with and without base isolation, respectively, and the damping of the system increased about 5 times due to base isolation. The experimental tool developed here was implemented in an undergraduate course “Introduction to Earthquake Engineering”, and the results of student analyses are presented. Overall the base isolated system showed a significant improvement in dynamic response of the model structure by reducing the lateral acceleration and increasing the damping of the system.

INTRODUCTION

Background

Seismic isolation bearings are structural joints that are installed between a structure and its foundation support columns. The purpose is to minimize damage caused by large lateral displacements observed during earthquakes. Three types of seismic isolation bearings are commonly used in practice. High Density Rubber Bearings (HDRB) are comprised of specially formulated high density rubber disks that serve as

⁽¹⁾ Student and ⁽²⁾ Faculty, Department of Civil Engineering, California State University, Sacramento, 6000 J St., Sacramento, CA 95819-6129.

a damping agent¹. Laminated Rubber Bearings (LRB) are similar in design to HDRB however, they use a different type of rubber for damping of the structure. Friction Pendulum Bearings (FPB), as shown in **Figure 1**, are made up of a dense chrome over steel concave surface in contact with an articulated friction slider and free to slide during lateral displacements².

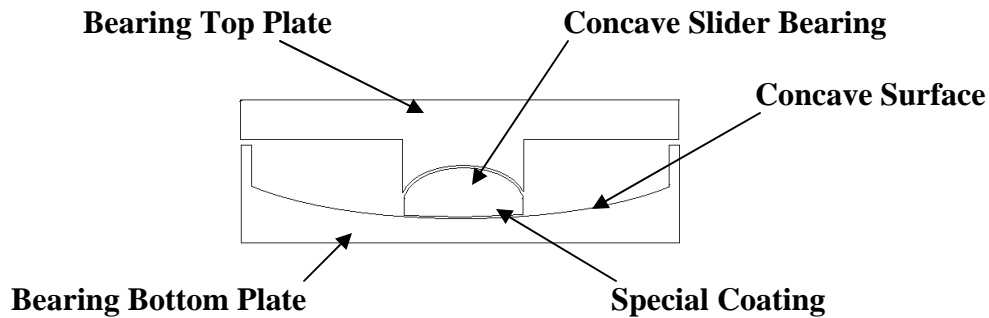

Figure 1. Cross-section of a friction pendulum bearing

Friction Pendulum Bearings are specially designed for each facility based on the load capacity requirements, earthquake displacement capacity, soil conditions, and the size of the structure being supported³. Bearings can be designed to accommodate different magnitudes of displacement simply by adjusting the curvature and diameter of the bearing surface. Typically Friction Pendulum bearings measure 3 feet in diameter, 8 inches high, and weigh 2000 pounds. Bearings can vary from the typical 3 foot diameter bearing to the world's largest bearing constructed for the Benicia-Martinez Bridge, which measures 13 feet in diameter³. The Friction Pendulum Bearings used in the Benicia-Martinez Bridge in the San Francisco Bay Area, as shown in **Figure 2**, weigh 40,000 pounds each and can displace up to 53 inches. The shiny surface on the inside of the bearing is the dense chrome which reduces the friction between the articulated slider and the concave surface to allow for lateral displacement when ground shaking occurs.



Figure 2. Bearing used in the Benicia Martinez Bridge³

Concept of Friction Pendulum Bearings

Friction Pendulum Bearings work on the same principle as a simple pendulum. When activated during an earthquake, the articulated slider moves along the concave surface causing the structure to move in small simple harmonic motions, as illustrated in **Figure 3**. Similar to a simple pendulum, the bearings increase the structures natural period by causing the building to slide along the concave inner surface of the bearing. The bearings filter out the imparting earthquake forces through the frictional interface². This frictional interface also generates a dynamic friction force that acts as a damping system in the event of an earthquake. This lateral displacement greatly reduces the forces transmitted to the structure even during strong magnitude eight earthquakes. This type of system also possesses a re-centering capability, which allows the structure to center itself, if any displacement is occurred during a seismic event due to the concave surface of the bearings and gravity².



Figure 3. Concept of sliding pendulum motion¹

Project Objective

The objective of this study is to model a base isolation system to physically demonstrate the concept of Friction Pendulum in the laboratory for earthquake engineering education. The responses of a single degree of freedom system with and without base isolation are measured simultaneously for free and forced vibrations using the accelerometers attached to the top of the structures. The responses of two systems are compared to understand the effectiveness of the base isolation system to reduce lateral accelerations caused by an earthquake.

DEVELOPMENT OF EQUIPMENT

Overview and Initial Plan

The preliminary model of a Friction Pendulum bearing is consisted of a simple spring system connected to an anchor, as shown in **Figure 4**.

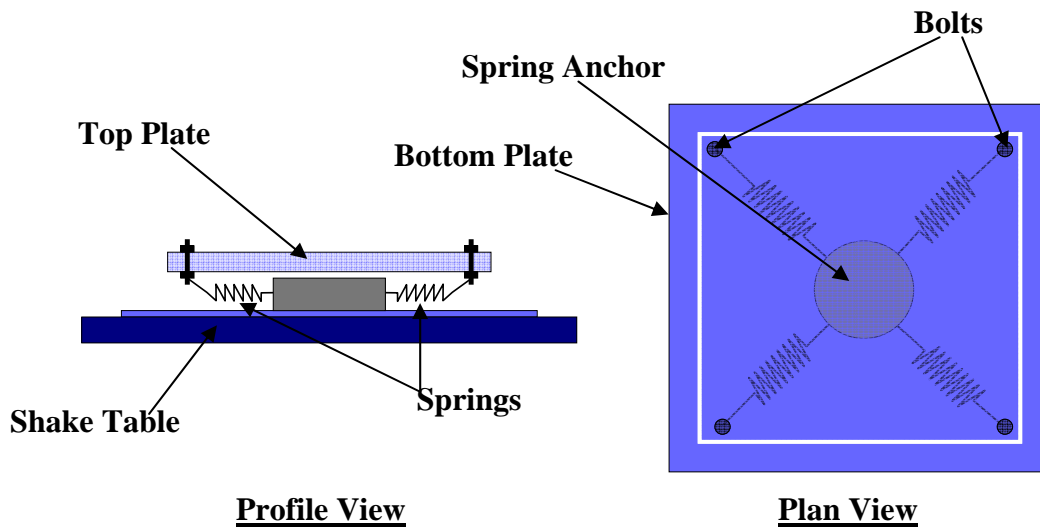

Figure 4. Preliminary design of friction pendulum system

This model was developed to simulate the pendulum motion of a single Friction Pendulum Bearing. The springs acted as the force that centered the system when it was displaced in any direction. The preliminary model was modified slightly to improve the response of the system. The new design had four actual bearings machined to reduce the friction and better represent the response of an actual pendulum system. Four columns were added to the top plate to raise the plate above the spring anchor resting inside the Friction Pendulum Bearings (See **Figure 5**).

Materials Used

The top and bottom plates of the system were fabricated from clear Acrylic Plastic of 12 inches by 12 inches and the spring anchor was fabricated from nylon plastic. The FPBs, 3 inches in diameter, were machined from Acrylic plastic at PK Machining in Sacramento. The columns of the system are comprised of 1-1/2 in bolts with a 1/2 in diameter acrylic ball on the end. The columns rest on the bearings with the acrylic ball acting as the slider. Four stainless steel household springs were connected to each column and to the anchor plate. Oil was used as a lubricant to create a frictionless surface between the column and bearing. The two model structures were also built from clear acrylic plastic and held together with 1/2 in stainless steel bolts.

Connections and Support System

Figure 5 shows the final design of the base isolation system. The spring anchor and the Friction Pendulum Bearings were mounted to the bottom plate of the system. Then, the columns were connected to the top plate and the springs were connected to the columns of the top plate. The model structure was bolted to the top plate with the accelerometer attached to the top. This set up allows both systems (i.e., models with and without base isolation system) to be tested simultaneously.

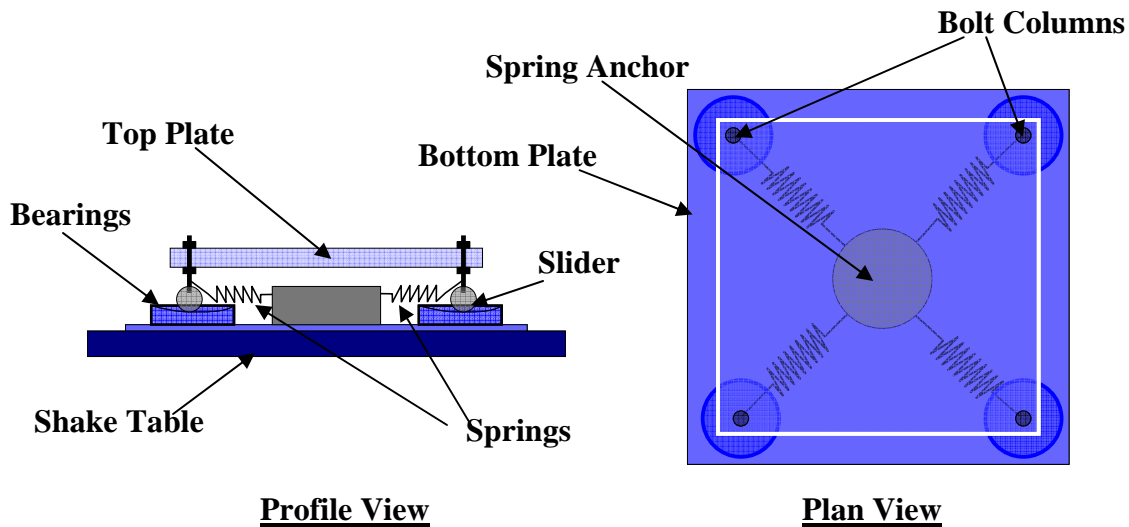

Figure. 5. Final Design of Friction Pendulum System

EXPERIMENTAL SET UP

Shake Table

The Shake Table II, developed by Quanser⁴, was used as the base acceleration system to simulate the lateral forces and displacements caused by an earthquake. The table is 18 in by 18 in and the one dimensional lateral motion is powered by a 1 Hp brushless servo motor that drives a 1 in lead screw. The lead screw drives a circulating ball which drives the table. The maximum travel of the table is +/- 7 cm and it can drive a 15 Kg mass at 2.5g. The shake table was connected to the Data Acquisitions system (DAS) to record the lateral accelerations of the structures on the table.

Components

The experiment setup is shown in **Figures 6** and **7**. Both model structures (with and without isolation system) were made from the same flexible material and mounted on the same shake table to allow comparison of the responses of the two structures during lateral loading. Each structure had an accelerometer attached to the top that measured the acceleration at the top of the structure during testing. A Data Acquisition System (DAS) recorded the data from the accelerometer. The DAS consisted of a standard computer with standard peripherals. Some pictures of the experimental setup and the DAS are available in the Appendix.

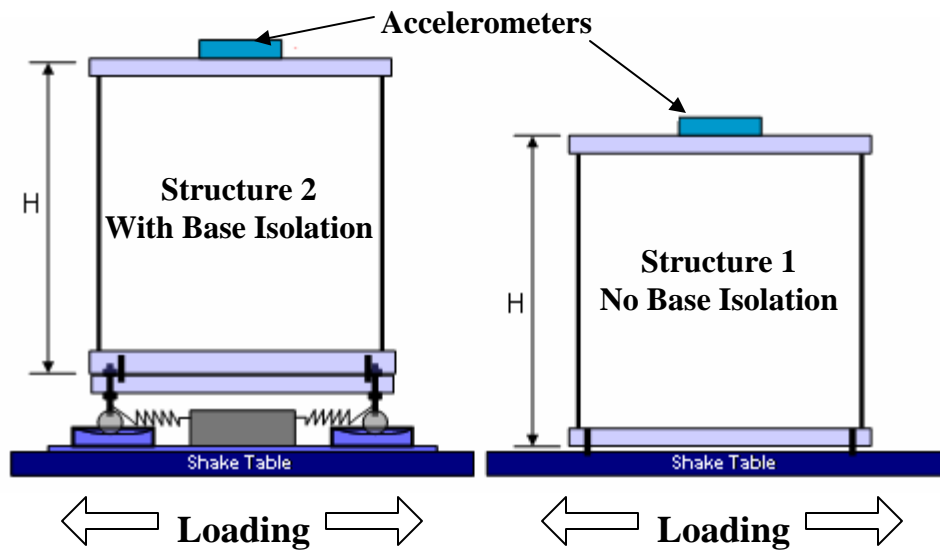

Figure 6. Experimental Setup



Figure 7. Experimental setup on shake table

TESTING AND RESULTS

Free Vibration

The first sequence in the experiment testing was to get the response of the structures under free vibration. An equal drift was applied to the top of both structures with and without base isolation system. The force was released and the structures allowed to oscillate until the natural damping of the structures brought the system to stop. The accelerometers recorded the acceleration that each structure experienced until they stopped oscillating. **Figure 8** shows the responses of these two structures.

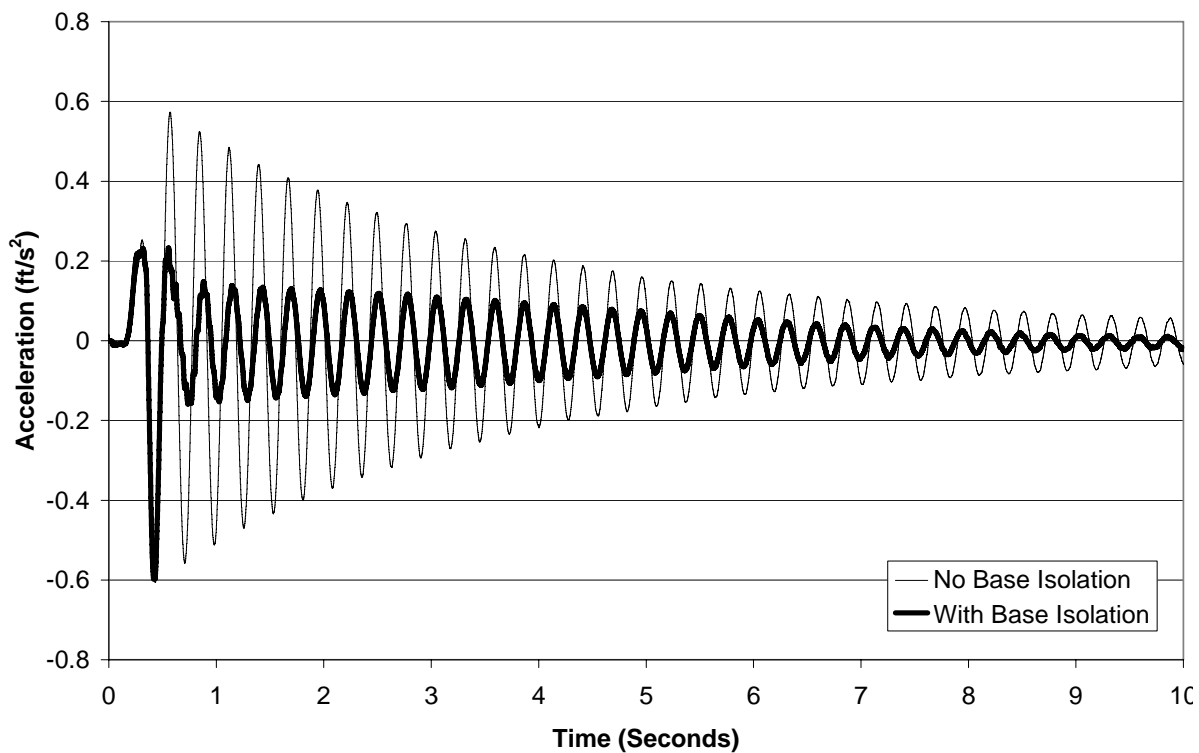

Figure 8. Responses of the model structures under free vibration

Forced Vibration

The second sequence of experiment was the forced vibration of the structures. The shake table was loaded with an increasing acceleration (sweep) for a period of 10 seconds. The acceleration of each structure was recorded and the responses of both structures were recorded, as shown in **Figure 9**.

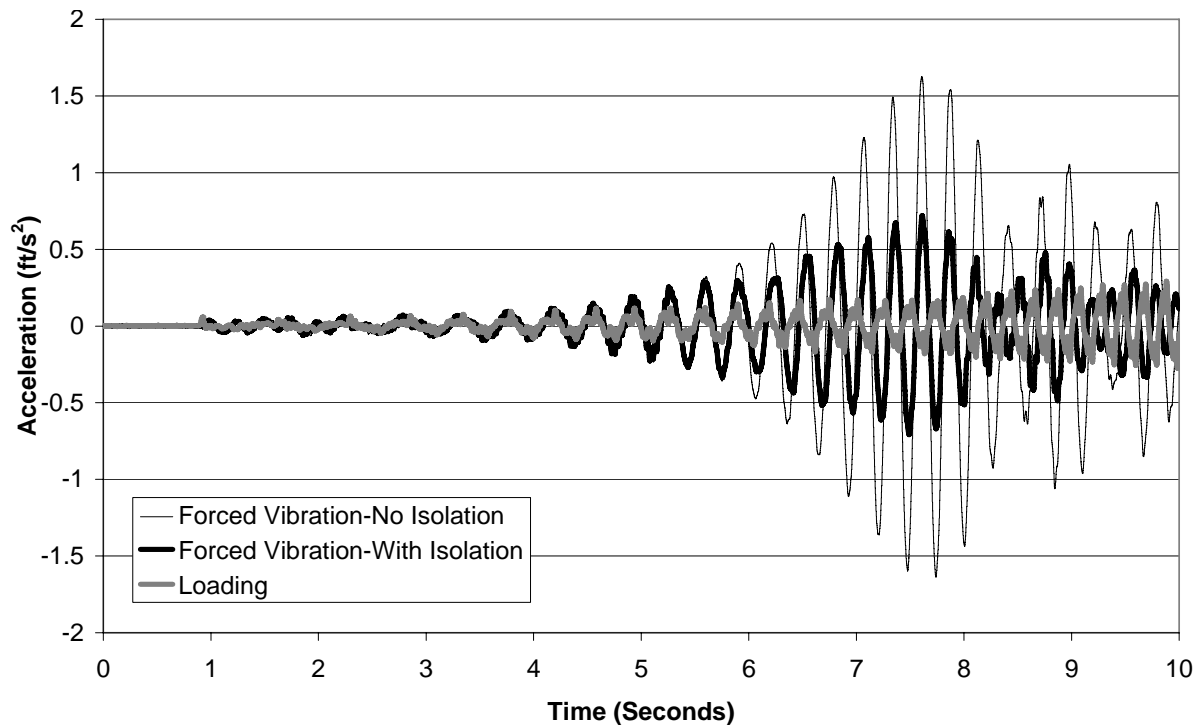

Figure 9. Responses of the model structures under forced vibration

Estimation of Damping

The damping is obtained from a second order differential equation for free vibration of a SDOF system ^{5,6}:

$$m\ddot{u}(t) + c\dot{u}(t) + ku(t) = 0 \quad (1)$$

where m is the mass of the system, $u(t)$ is displacement, c is damping coefficient, and k represents the stiffness of the system. The damping ratio for the system is estimated using the logarithmic decrement method which is the ratio of two consecutive peaks of acceleration-time history over one period. **Figure 10** shows a generic response of a SDOF system with two successive peak values to calculate the damping. Accordingly, the damping ratio is estimated by combining the differential equation and the logarithmic decrement method, as follows:

$$\zeta = \ln(y_1 / y_2) / 2\pi \quad (2)$$

The results of the experiments and the calculation of damping using Eq. 2 are presented in next section.

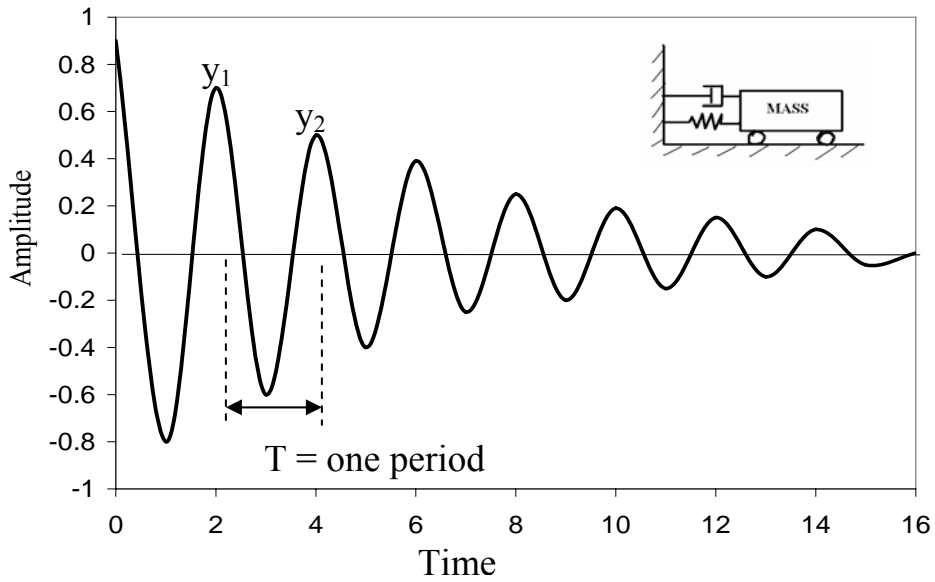

Figure 10. Response of a SDOF system with free vibration

Results

The maximum accelerations experienced by both structures with and without isolation system are summarized in **Table 1**. The free vibration test showed a significant increase in damping with the base isolation system to the structure as seen in **Figure 8**. The damping, calculated using Eq. 2, shows that the Friction Pendulum System increased damping by almost 5 times. From the forced vibration, as shown in **Figure 9**, the responses of both model structures showed a significant decrease in spectral acceleration at the top of the structures. The maximum accelerations experienced by the structures with and without base isolation system were 0.23g and 0.57g, respectively. This means about 60 percent decrease in acceleration due to the base isolation system.

Table 1. Results of the shake table tests

	Free Vibration		Forced Vibration	
	With Base Isolation	Without Base Isolation	With Base Isolation	Without Base Isolation
Maximum acceleration, g	0.23	0.57	0.72	1.63
Damping ratio, ζ	0.085	0.016	-	-

IMPLEMENTATION IN A COURSE

The base isolation experiment was implemented in the undergraduate course “Introduction to Earthquake Engineering” at California State University, Sacramento in Fall 2007. The students were expected to calculate the damping of the SDOF system with and without the base isolation. **Table 2** summarizes the statistical data based on multiple solutions using different peak values obtained from acceleration-time histories. **Figure 11** shows a histogram representing variation in calculation of damping ratios calculated by the students.

Table 2. Student exercise damping results

	Without Base Isolation	With Base Isolation
Sample Size	17	17
Maximum	0.050	0.104
Minimum	0.008	0.010
Average	0.019	0.058
Standard Deviation	0.009	0.028

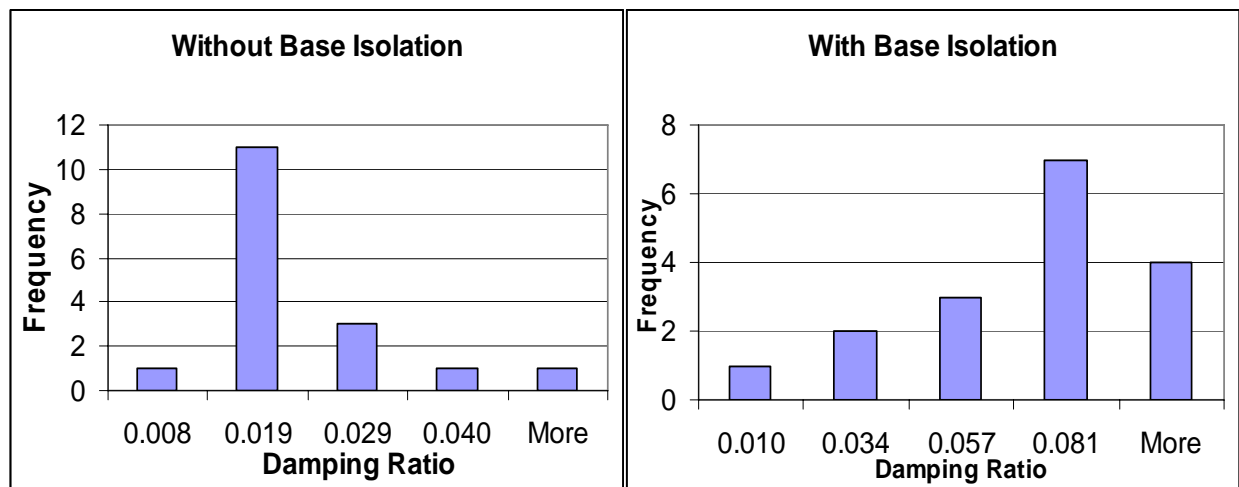

Figure 11. Histogram of the results from student analyses

REAL-WORLD APPLICAIIONS

Friction Pendulum Bearings have been used for a variety of structures for buildings, bridges and other structures to reduce damages caused by an earthquake. The bearings are custom designed and manufactured for each structure depending on a variety of factors. **Table 3** presents several-real world applications of Friction Pendulum Bearings for a variety of projects.

Table 3. Case histories of Friction Pendulum Bearings³

Project Name	Structure Type	Facts
Seahawks football Stadium	Stadium	<ul style="list-style-type: none"> ▪ Supports 3 million pounds of load ▪ One-way bearings accommodate thermal and seismic movements ▪ Were activated in the Nisqually, Washington earthquake
US Court of Appeals, San Francisco, California	Building	<ul style="list-style-type: none"> ▪ 256 Bearings ▪ 24% savings in cost with the use of bearings ▪ Structure stresses reduced by 80%
San Francisco International Airport, California	Airport	<ul style="list-style-type: none"> ▪ 267 Bearings ▪ Can resist a magnitude 8 earthquake ▪ Largest isolated building in the world ▪ 70% reduction in lateral forces
American River Bridge, Folsom, California	Bridge	<ul style="list-style-type: none"> ▪ 10 inch displacement capacity ▪ Support 4 million pounds of load ▪ Saved \$1 million in construction costs
Liquefied Natural Gas Tanks, Revithoussa, Greece	Gas Tanks	<ul style="list-style-type: none"> ▪ 212 Bearings ▪ Reduction of lateral shear on tanks by 80% ▪ Support 2 million pounds of load ▪ 12 inch displacement capacity

CONCLUDING REMARKS

The objective of this study was to model the concept of base isolation systems and verify the reduction in lateral response due to a seismic event. The difference in responses was measured by comparing two identical model structures, one with a Friction Pendulum Bearing base isolation system and one without any base isolation. After extensive testing on a Shake Table, the structure with the Friction Pendulum Bearing base isolation showed a significant decrease in lateral acceleration due to varying lateral forces, as expected. The maximum lateral acceleration observed for the base isolated structure was 0.23g which was less than half of the non-base isolated structure that experienced a maximum lateral acceleration of 0.57g. The calculated damping of each structure showed a similar trend with the base isolated structure having a damping of 0.085 which was more than five times greater than the non-base isolated structure with a damping of 0.016. This experiment was implemented in an undergraduate course and the statistical results of damping calculation are reported in Table 2. Overall the Friction Pendulum Bearing base isolated system showed a significant improvement in dynamic response of the model structure by reducing the lateral acceleration and increasing the damping of the system.

ACKNOWLEDGEMENTS

The authors would like to appreciate the American Public Works Association (APWA) and National Science Foundation (NSF) for providing funding for shake tables at California State University, Sacramento. Prof. Shirley Dyke of Washington University is the PI and project director for the NSF/CCLI project on “Deployment and integration of instructional shake tables using the NEES cyber infrastructure”. Appreciation is extended to Emir Macari, Dean of College of Engineering, Earthquake Protection Systems (EPS) and Miyamoto International for their support of the project. The Friction Pendulum Bearing is a trademark of Earthquake Protection Systems, Inc. Many thanks to PK Machining for assistance with machining the acrylic bearings used in the system. Finally, the authors acknowledge the college equipment technicians Bruce Scott, James Ster, and James Penaluna for fabricating some components and assistance with installation of the system to the shake table.

REFERENCES

1. Wang, Y. P. (2002) *Fundamentals of Seismic Base Isolation*. International training program for seismic design of building structures, sponsored by National Science Council, National Chiao-Tung University, Hsinchu, Taiwan.
2. Wang, Y. P., Chung, L. L. and Liao, W. H. (1998). *Seismic Response Analysis of Bridges Isolated with Friction Pendulum Bearings*, Earthquake Engineering and Structural Dynamics, Vol. 27, 1069-1093.
3. Earthquake Protection Systems (EPS), *Friction Pendulum Seismic Isolation Bearing*. <<http://www.earthquakeprotection.com>> Last accessed December 1, 2007.
4. Quanser Inc., <http://www.quanser.com>. Last accessed December 4, 2007.
5. Chopra, A. (1995) *Dynamics of Structures: Theory and Applications to Earthquake Engineering*, Second Ed., Prentice Hall, Inc, Upper Saddle River, N. J.
6. Clough, R.W. and Penzien, J. (1993) *Dynamics of Structures*, McGraw-Hill, Inc., N.Y.

APPENDICES

- A1 – Setup for friction pendulum base
- A2 – A close up view of experimental friction pendulum bearing
- A3 – Load applied by shake table (Forced Vibration)
- A4 – Lateral acceleration of structure with FPB base isolation (Forced Vibration)
- A5 – Lateral acceleration of structure without base isolation (Free Vibration)
- A6 – Lateral acceleration of structure with base isolation (Free Vibration)

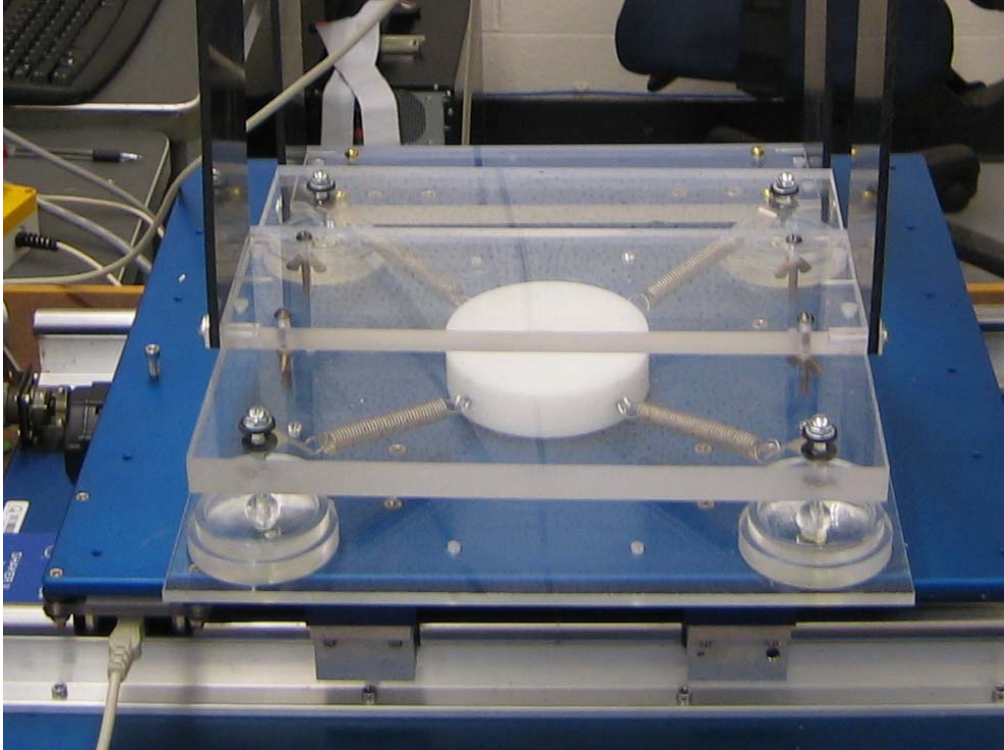

A1 – Setup for friction pendulum base

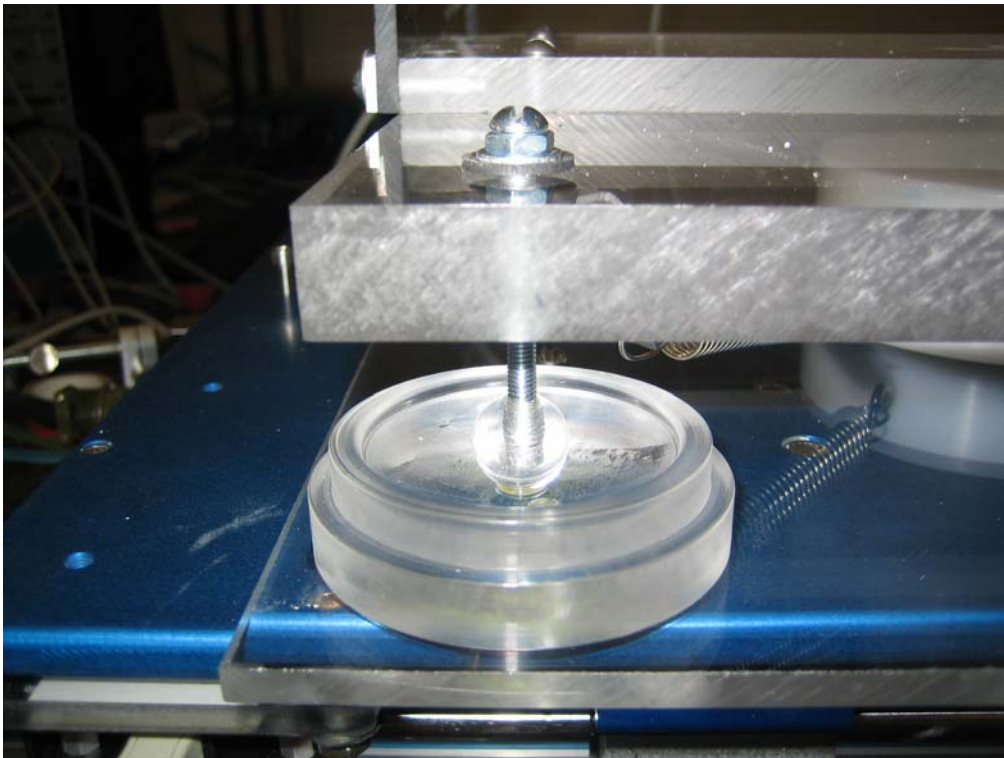

A2 – A close up view of experimental friction pendulum bearing

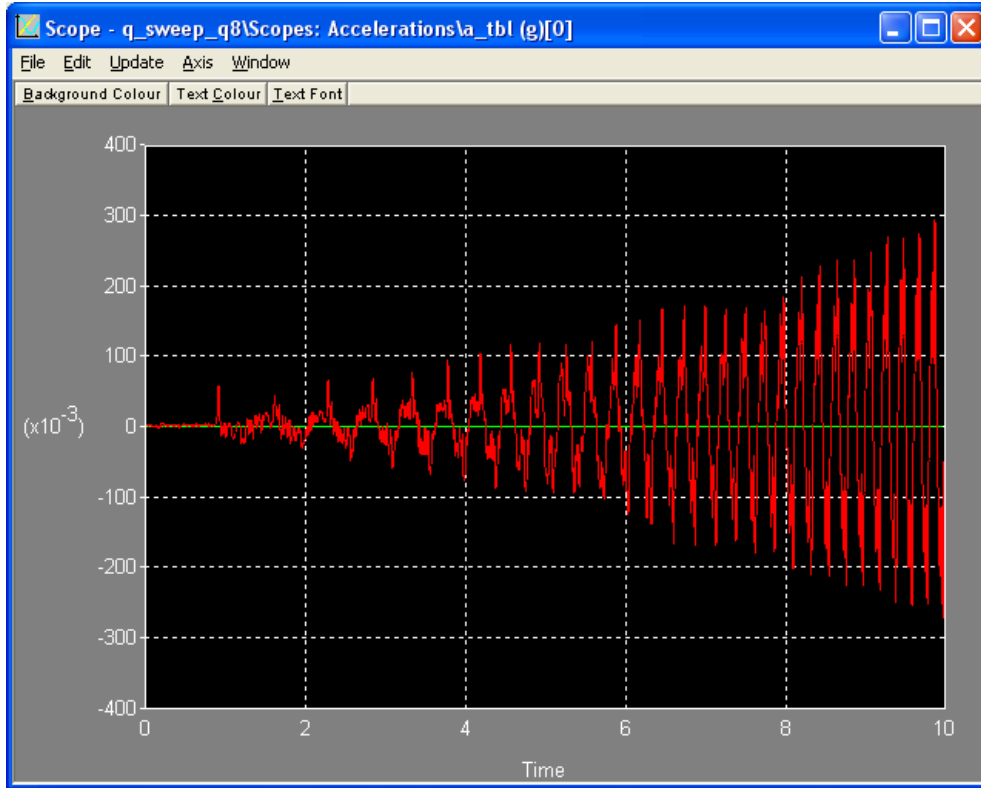

A3 – Load applied by shake table (Forced Vibration)

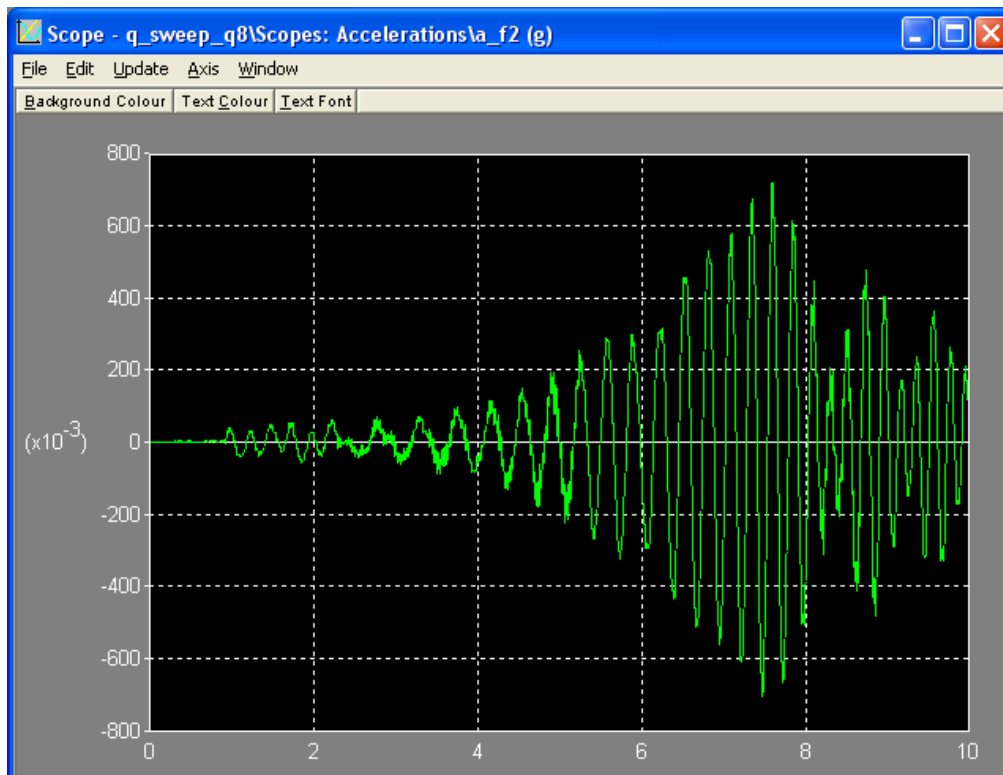

A4 – Lateral acceleration of structure with FPB base isolation (Forced Vibration)

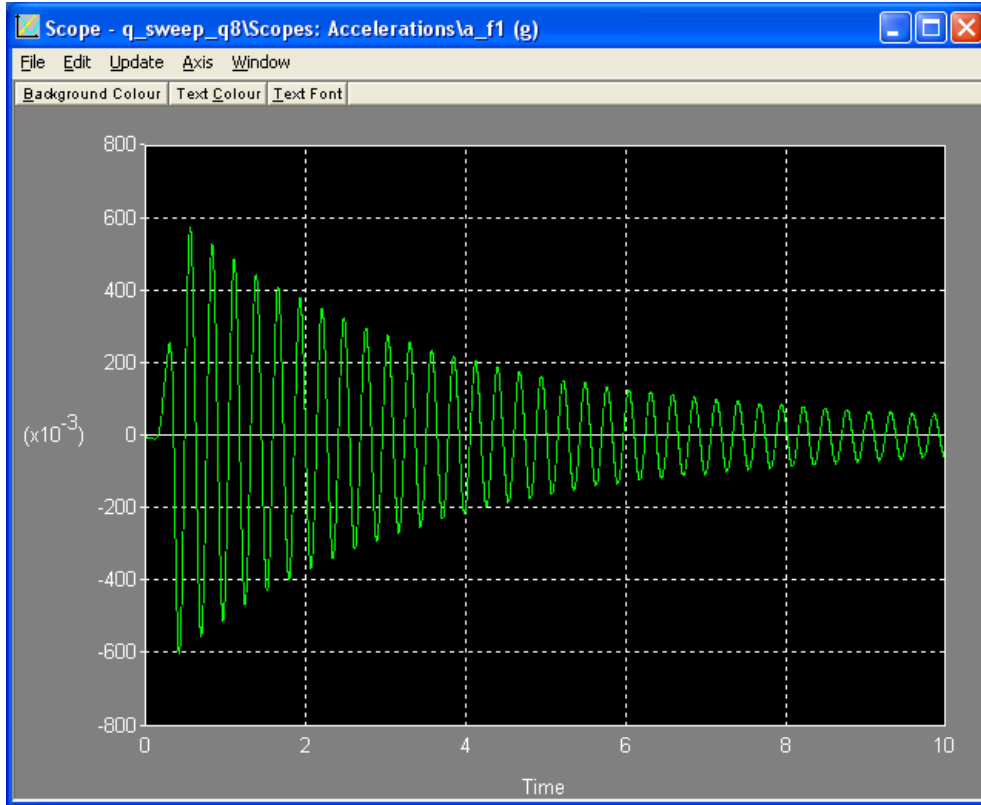

A5 – Lateral acceleration of structure without base isolation (Free Vibration)

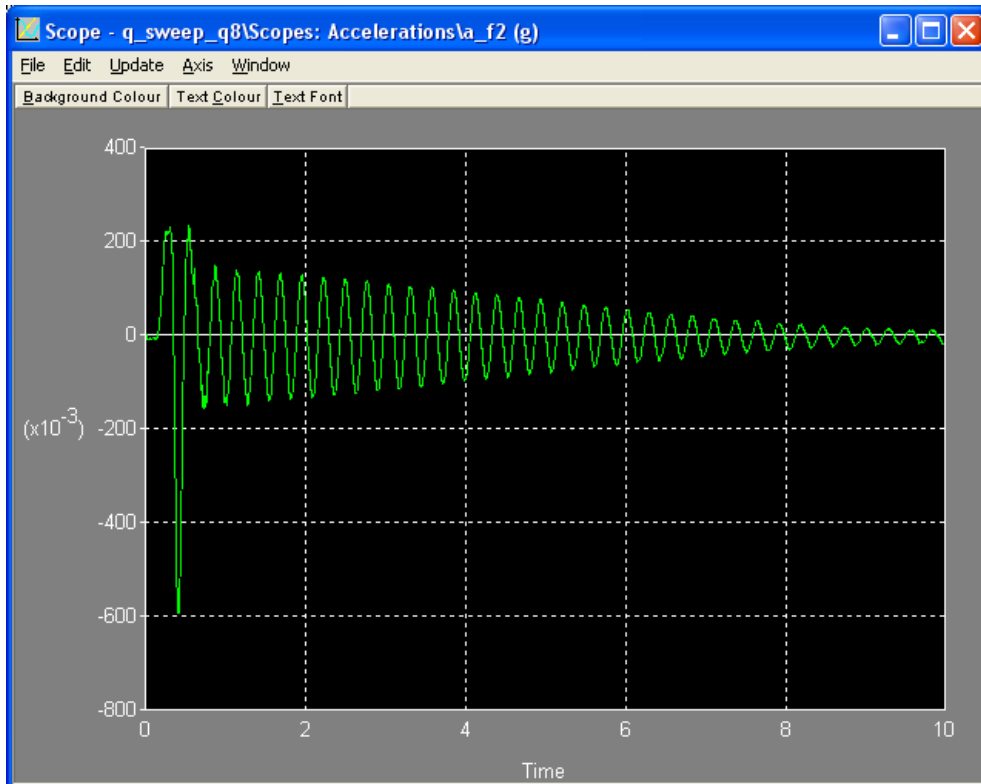

A6 – Lateral acceleration of structure with base isolation (Free Vibration)