

OBSERVATION OF MULTIPHOTON PROCESS IN LIQUID CS₂ USING PULSED PHOTOACOUSTIC TECHNIQUE

S. S. HARILAL, RIJU C. ISSAC, C. V. BINDHU, GEETHA K. VARIER,
V. P. N. NAMPOORI and C. P. G. VALLABHAN
*Laser Division, School of Photonics,
Cochin University of Science and Technology,
Cochin 682 022, India*

Received 27 April 1995

Pulsed photoacoustic measurements have been carried out in liquid CS₂ using 532 nm radiation from a frequency doubled Nd:YAG laser. Variation of signal amplitude with laser fluence clearly indicates the role of multiphoton processes in the generation of photoacoustic effect. It is also shown that four photon induced dissociation and five photon induced ionization are likely processes in CS₂ and 532 nm radiation.

1. Introduction

Multiphoton processes in gaseous and condensed phases of matter belong to the class of nonlinear optical phenomena which have received increasing attention in recent years due to the availability of high power pulsed lasers with which such effects can be induced easily. Also the advancement in the area of signal processing and data acquisition techniques has given further impetus to these studies. Direct optical absorption measurements, so common in one photon spectroscopy, are not quite suitable in these investigations due to the extremely small values of multiphoton absorption cross section. Multiphoton processes are usually investigated using alternate techniques like two/three photon induced fluorescence emission, which is effective only in cases where the fluorescence quantum yield is sufficiently high. Many photon phenomena in liquids and solids are much less investigated as compared to those in gases. Phenomena like multiphoton ionization (MPI) in condensed phase are of considerable importance not only as a means of detecting nonlinear absorptions, but also because it describes the charge separation mechanism in condensed media. Since the initial report of MPI in benzene by Vaida *et al.*,¹ many more studies have appeared in literature, mostly pertaining liquid benzene.^{2,3} Some works on MPI of CS₂ are also available in literature.⁴⁻⁷ All the above studies on CS₂ have been carried out using molecular beam and excimer laser as excitation source.

PACS Nos.: 7.64, 32.80Rm.

Also they use either multiphoton fluorescence technique or microwave absorption by free radical produced due to ionization. The multiphoton process in CS₂ are even more diverse and less clearly understood. The photochemistry of CS₂ is sensitive to the wavelength of photolysis.

Quite recently techniques based on the thermo-optic effect, which monitor non-radiative de-excitations of excited atoms/molecules, have been proven to be very effective methods to detect multiphoton processes.^{8,9} Of these various thermo-optic phenomena, photoacoustic (PA) and thermal lens effects are the two widely employed tools to detect very weak processes like many photon absorption. The present paper deals with the observation of multiphoton induced photoacoustic effect in CS₂ liquid using the 532 nm radiation from a frequency doubled Nd:YAG laser. To the best of our knowledge, this is the first report which describes multiphoton dissociation in liquid CS₂.

The pulsed PA signal $q(\nu)$ generated in an absorbing liquid due to multiphoton absorption at frequency ν is given by¹⁰

$$q(\nu) = AI(\nu)^n \eta(\nu), \quad (1)$$

where $I(\nu)$ is the incident laser power and $\eta(\nu)$ is the quantum yield of the non-radiative transition. The constant A is a function of the cell geometry, acoustic transducer properties and the ultrasonic attenuation in the solution. From Eq. (1), a log-log plot of $q(\nu)$ versus laser power $I(\nu)$ will give the slope n corresponding to the number of photons taking part in the multiphoton process.

2. Experimental Setup

The schematic experimental setup is shown in Fig. 1(a). The PA cell is made of stainless steel and it is provided with glass windows for the entry and exit of the laser beam (Fig. 1(b)). The acoustic transducer that detects the laser induced PA signals consists of a lead-zirconate-titanate (PZT) disc of 4 mm thickness and 15 mm diameter, firmly mounted in a stainless steel chamber which is screwed onto the PA cell. The purpose of mounting the PZT disc inside the stainless steel casing is to minimize external electrical pick up and to prevent sample contamination by PZT (and vice versa). The diaphragm of the transducer chamber has a thickness of 0.5 mm and it is finely polished. A lead disc followed by a copper disc forms the backing of the PZT, which is spring loaded within the chamber. Spurious electrical pick-up is negligible, and signal ringing is reduced to a tolerable level.

The second harmonic output beam (532 nm) from a Q-switched pulsed Nd:YAG laser (Quanta-Ray, DCR-11) is focused by a convex lens (focal length 5 cm) into the PA cell containing carbon disulphide (spectroscopic grade) liquid at room temperature (20°C). The lens position is adjusted so that the beam focus is at the centre of the cell. A dichroic filter oriented at 45° to the beam axis separates the fundamental frequency component (1064 nm) from the second harmonic. The laser pulse width (FWHM) is \simeq 8 ns and the pulse repetition frequency is 10 Hz. The incident power is monitored by a laser power meter (Scientech model 362) and the

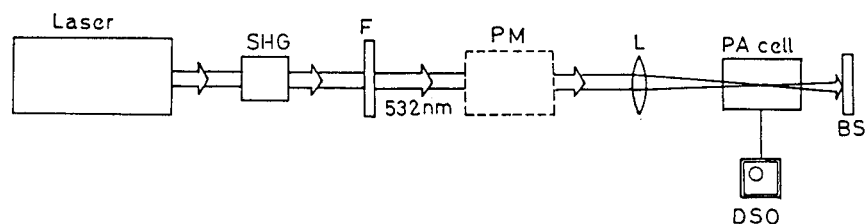

(a)

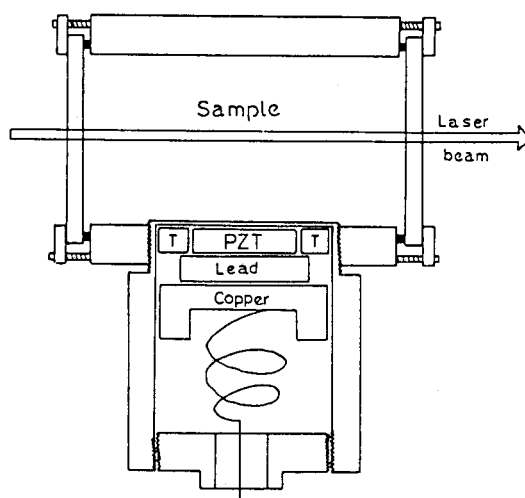

(b)

Fig. 1. (a) Schematic diagram of the experimental setup: SHG, second-harmonic generator; F, dichroic filter; PM, laser energy meter; L, convex lens; DSO, digital storage oscilloscope; and BS, beam stopper. (b) Photoacoustic cell and transducer chamber: PZT, lead zirconate titanate disc; and T, teflon ring.

transducer output is observed on a digital storage oscilloscope (Iwatsu model DS 8621). The averaged amplitude of the first pulse in the PA signal trace is monitored as a function of the laser power.

3. Results and Discussion

The log-log plot of PA signal strength versus laser power is given in Figs. 2 and 3 respectively for two different ranges (lower and higher) of laser powers. The plot has three parts: (a) lower power region in which slope is ~ 2 ; (b) medium power region in which slope is ~ 4.5 and (c) high power region where the slope comes to a value below 2 and saturates.

The above results clearly indicate the role of many photon processes in the generation of PA signal from the sample (CS_2). It is obvious that the various photochemical/photochemical processes are distinctly different at the different ranges

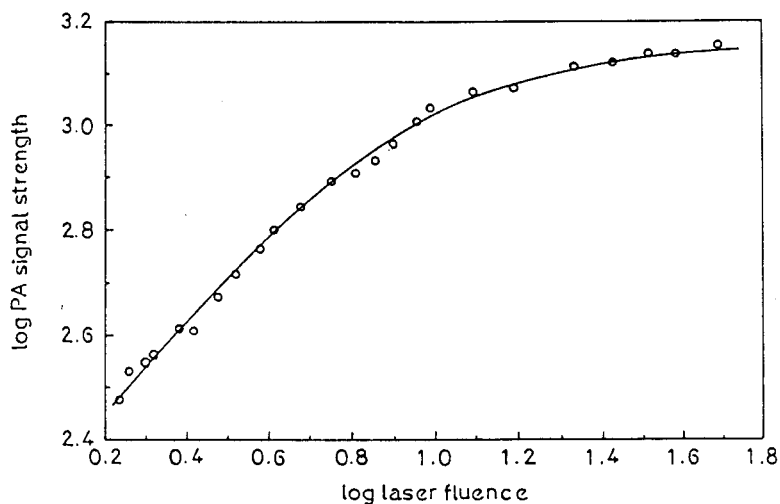

Fig. 2. Log-log plot of PA signal strength with laser filter.

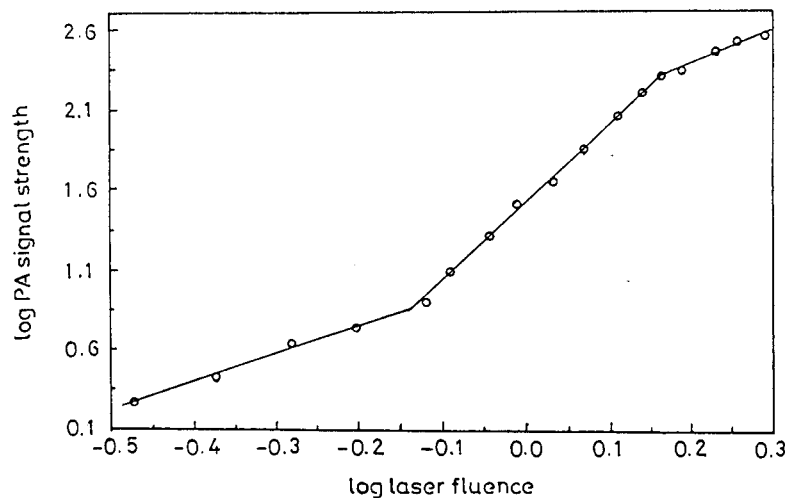
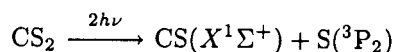

Fig. 3. Log-log plot of PA signal strength with laser fluence showing saturation at higher fluences.

of incident laser power. Thus we can attribute two, four and five photon process in the generation of PA signal from CS_2 with 532 nm excitation. A nonradiative component of de-excitation is essential for the generation of PA signal in a sample following the multiphoton absorption. Accordingly, ionization or dissociation of molecules can lead to thermo-optic effect and hence a PA signal. We may consider the following as the most likely processes taking place in the present case.

In the low fluence region, CS₂ dissociation can be attributed to breaking of SC-S bond following the scheme⁵



corresponding to 4.46 eV which matches with two photon energy of 532 nm radiation. Absorption of two photons at 532 nm excites the CS₂ molecules leading to production of CS ($X^1\Sigma^+$) and sulphur atoms in the $^3\text{P}_2$ states ($^3\text{P}_2$ being the ground state of sulphur atoms). However, as described by Hardwick *et al.*⁴, the above process is not a spin allowed process. The first spin allowed process is

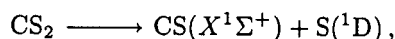

which requires 5.687 eV that does not match with either two photon or three photon processes. The present observation of the clear signature of two photon process favors the dissociation of CS₂ into CS ($X^1\Sigma^+$) and S ($^3\text{P}_2$). It should be remembered that selection rule corresponding to spin conservation are not as strong as other selection rules, especially in the condensed phase.

The observation of slope $\simeq 4.5$ at higher laser fluences indicate both four photon and/or five photon processes corresponding to 8.8 eV and 11.3 eV respectively¹¹

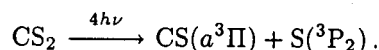

The process is energetically favored four photon process. By absorbing four photons at 532 nm, CS₂ molecules are excited to 3d Rydberg states $^1\Delta_u^7$ which predissociates giving sulphur atoms in the $^3\text{P}_2$ state and CS in the excited state ($a^3\Pi$).

At higher incident laser fluences CS⁺ can be produced by ionizing CS by absorbing five photons, i.e.

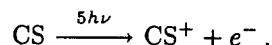

This corresponds to an energy of 11.3 eV.

A decrease in the value of slope at still higher laser fluence region indicates a saturation effect. Similar saturation effect was observed by Siomons *et al.*¹² in the study of pyrene solution in hexane.

In conclusion, we have demonstrated the occurrence of different multiphoton processes in liquid CS₂ using pulsed PA techniques. It may also be noted that the detection method used here is much simpler in comparison with other techniques customarily employed.

Acknowledgments

The authors wish to thank the Department of Science and Technology (Government of India) for financial assistance. SSH is thankful to Council for Scientific and

Industrial Research, New Delhi, and RCI and CVB are grateful to the University Grants Commission for their research fellowships.

References

1. Vaida, M. Robin, and N. A. Kuefler, *Chem. Phys. Lett.* **58**, 557 (1978).
2. T. W. Scott, A. J. Twarowski, and A. C. Albrecht, *Chem. Phys. Lett.* **66**, 1 (1979).
3. T. W. Scott and A. C. Albrecht, *J. Chem. Phys.* **74**, 3807 (1981).
4. J. L. Hardwick, Y. Ono, and J. T. Moseley, *J. Phys. Chem.* **91** 4506 (1987).
5. S. C. Yang, A. Freedman, M. Kawasaki, and R. Bersohn, *J. Chem. Phys.* **72**, 4058 (1980).
6. T. V. Venkitachalam and A. S. Rao, *Appl. Phys.* **B52**, 102 (1991).
7. T. V. Venkitachalam and A. S. Rao, *Spectrochim. Acta* **A48**, 1555 (1992).
8. P. Sathy, R. Philip, V. P. N. Nampoori, and C. P. G. Vallabhan, *Opt. Commun.* **74**, 313 (1990).
9. A. V. Ravi Kumar, G. Padmaja, V. P. N. Nampoori, and C. P. G. Vallabhan, *Pramana — J. Phys.* **33**, 621 (1990).
10. A. Rosenwaig, *Photoacoustics and photoacoustic spectroscopy* (Wiley, New York, 1980).
11. K. P. Huber and G. Herzberg, *Constants of diatomic molecules* (Van Nostrand - Reinhold, New York, 1979).
12. K. Siomos and L. G. Christophorou, *Chem. Phys. Lett.* **72**, 43 (1980).