

Week 5

Air conditioning processes
Refrigeration cycles

Today's Outline

- Evaporative cooling
- Adiabatic mixing of airstreams

Evaporative cooling

- Refrigeration cycle works great anywhere but costs money
- In desert, where it is hot and dry, we can avoid cost by using evaporative coolers or swamp coolers (take advantage of low humidity)
- As water evaporates the latent heat of vaporization is absorbed from water and surrounding air
- As a result, both water and air are cooled

Evaporative cooling - illustrated

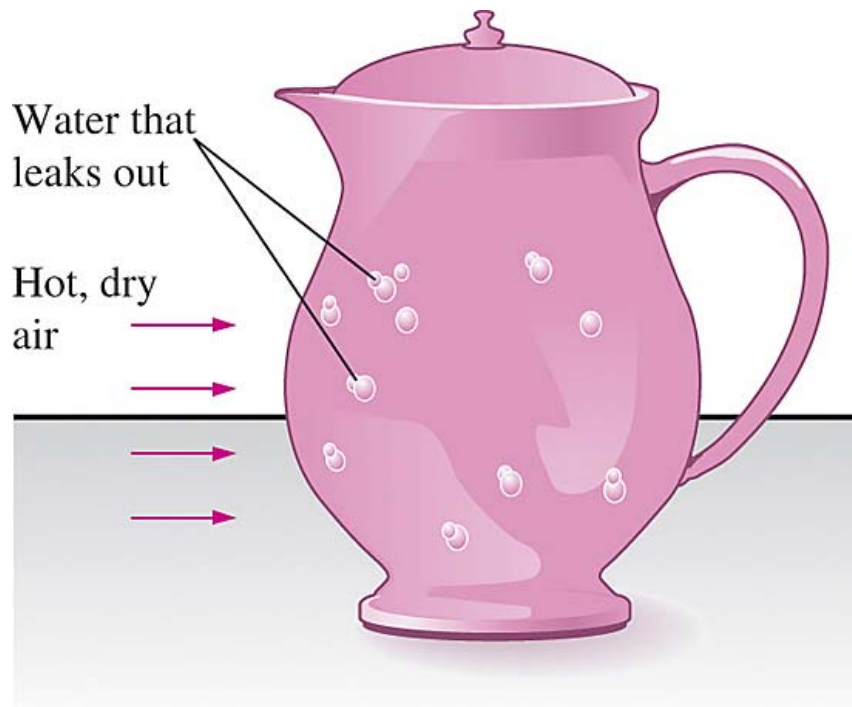

- The water in a porous jug left in an open breezy area cools
- This is due to evaporative cooling
- That is, the water evaporates and cools what is in the pitcher
- On a hot, dry day the air feels cooler when you water the lawn for same reason

Evaporative cooling - analysis

- We have cooling and humidifying
- Part of water evaporates by absorbing heat from airstream, hence air temperature decreases and relative humidity increases at state 2
- Limiting case air leaves saturated 2' (lowest temp. possible with process)

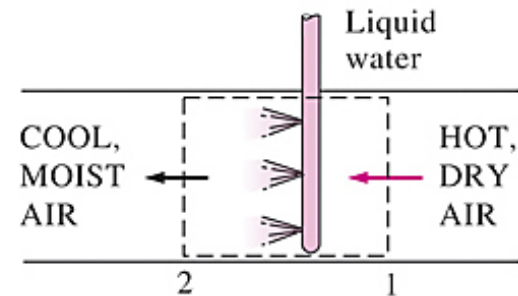
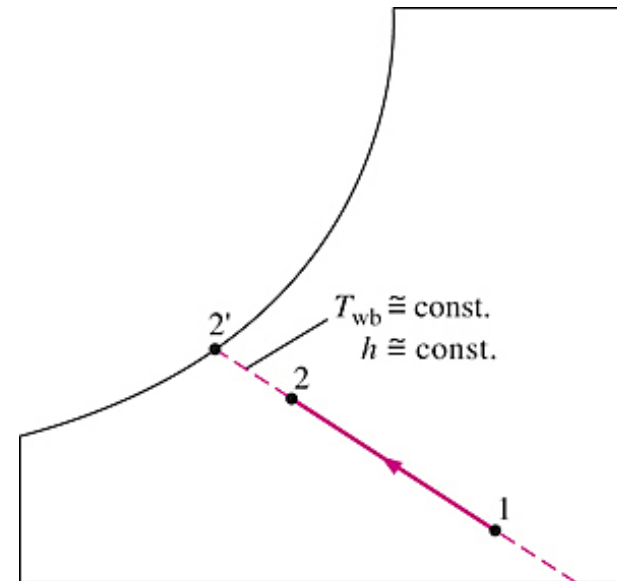

Evaporative cooling and adiabatic saturation

- Evaporative cooling similar to adiabatic saturation because heat transfer between airstream and surroundings is negligible
- Process follows line of constant wet-bulb temperature (liquid water must be supplied at exit temperature)
- Note: constant wet-bulb temp. implies constant enthalpy (from energy equation)

Example 14-7

- Air enters an evaporative (swamp) cooler at 14.7psia, 95 F, and 20% relative humidity, and it exits at 80% relative humidity. Determine (a) exit temperature of air and (b) lowest temperature to which the air can be cooled by evaporative cooler.

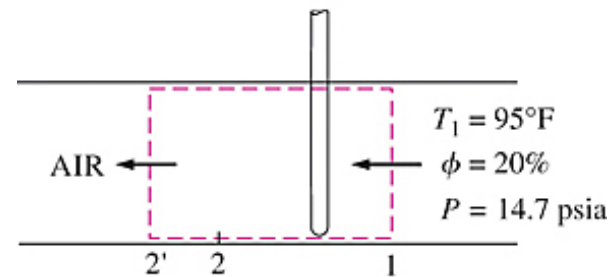
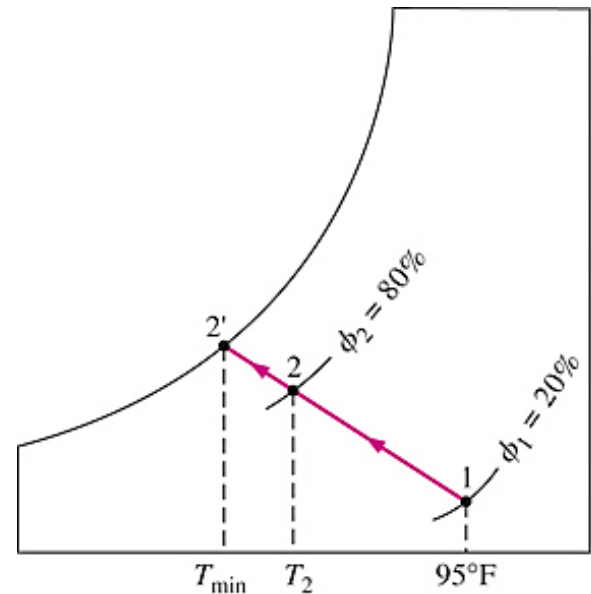

Example 14-7

Example 14-7

Adiabatic mixing of airstreams

- Here we condition air using outside fresh air – typical for large buildings, plants, hospitals, etc.

$$\dot{m}_{a,1} + \dot{m}_{a,2} = \dot{m}_{a,3}$$

$$\omega_1 \dot{m}_{a,1} + \omega_2 \dot{m}_{a,2} = \omega_3 \dot{m}_{a,3}$$

$$h_1 \dot{m}_{a,1} + h_2 \dot{m}_{a,2} = h_3 \dot{m}_{a,3}$$

$$\frac{\dot{m}_{a,1}}{\dot{m}_{a,2}} = \frac{\omega_2 - \omega_3}{\omega_3 - \omega_1} = \frac{h_2 - h_3}{h_3 - h_1}$$

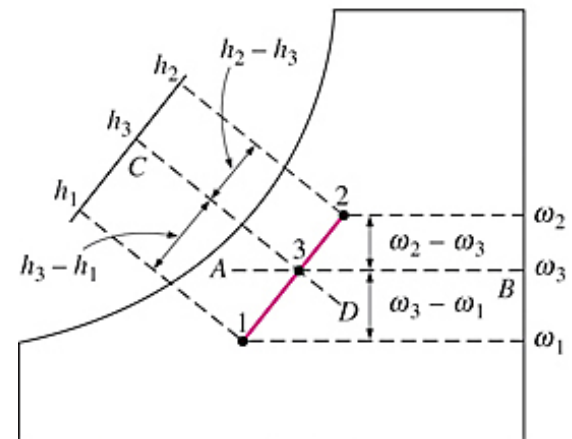
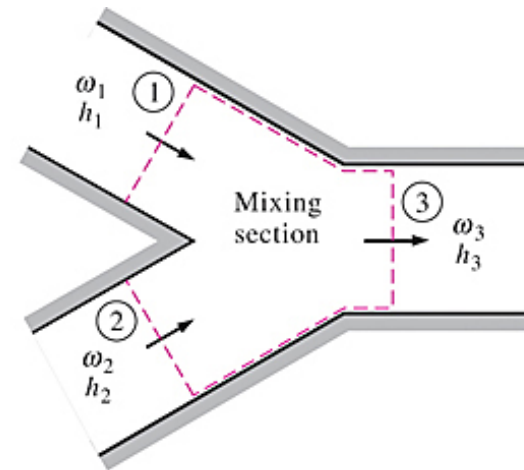

Example 14-8

- Saturated air leaving the cooling section of an AC system at 14 C at a rate of 50 m³/min is mixed adiabatically with outside air at 32 C and 60% relative humidity at a rate of 20 m³/min. Assuming mixing process occurs at pressure of 1 atm, determine specific and relative humidity, dry-bulb temperature, and volume flow rate of mixture.

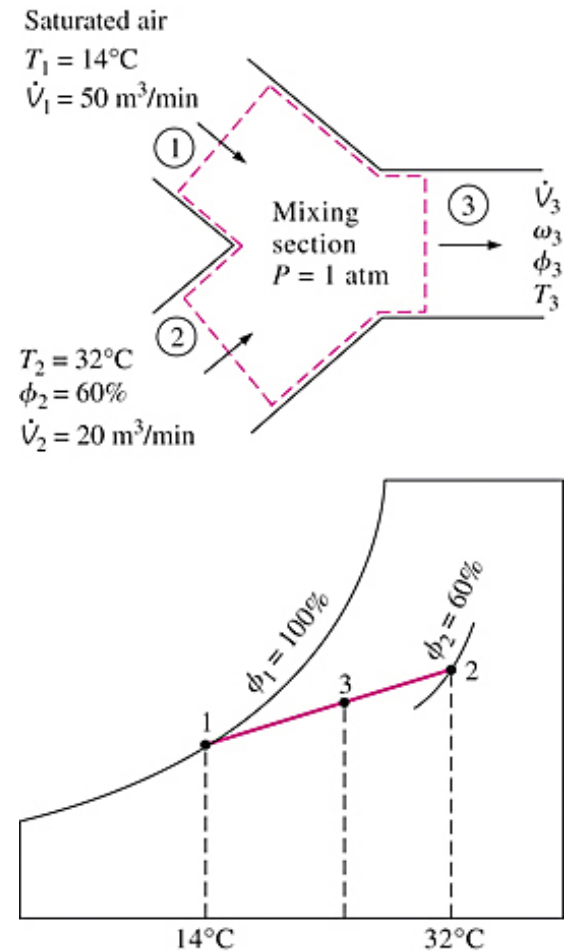

Example 14-8

Example 14-8

Example 14-8

Summary

- Most AC processes modeled as steady-flow processes so analysis involves steady-flow mass (for both dry air and water vapor) and energy balances:

$$\text{DRY AIR MASS: } \sum \dot{m}_{a,i} = \sum \dot{m}_{a,e}$$

$$\text{WATER MASS: } \sum \dot{m}_{w,i} = \sum \dot{m}_{w,e}$$

$$\text{or } \sum \dot{m}_{a,i} \omega_i = \sum \dot{m}_{a,e} \omega_e$$

$$\text{ENERGY: } \dot{Q} - \dot{W} = \sum \dot{m}_e h_e - \sum \dot{m}_i h_i$$

Summary

- In dry climates, air can be cooled via evaporative cooling by passing it through a section where it is sprayed with water
- Many AC applications involve mixing of two airstreams e.g. conditioned air and fresh outside air



Today's Outline

- Wet cooling towers

Wet cooling towers – why?

- In power plants a large part of the energy released by fuel must be rejected to environment e.g. waste heat
- Usually cool water from rivers/lakes used to carry off the energy rejected from condenser in power plant
- Either due to limited water supply or thermal pollution need an alternative
- Hence, they take warm water and cool it by an **evaporative cooling** process – **wet cooling tower**

Wet cooling towers – what?

- “Give the air a shower and cool the water”
- Air is drawn into tower from bottom and leaves out top via fan
- Warm water from condenser is pumped to top of tower and sprayed into airstream
- **Some water evaporates and cools remaining water** which gets sent back to power plant to pick up more waste heat (add make-up water)

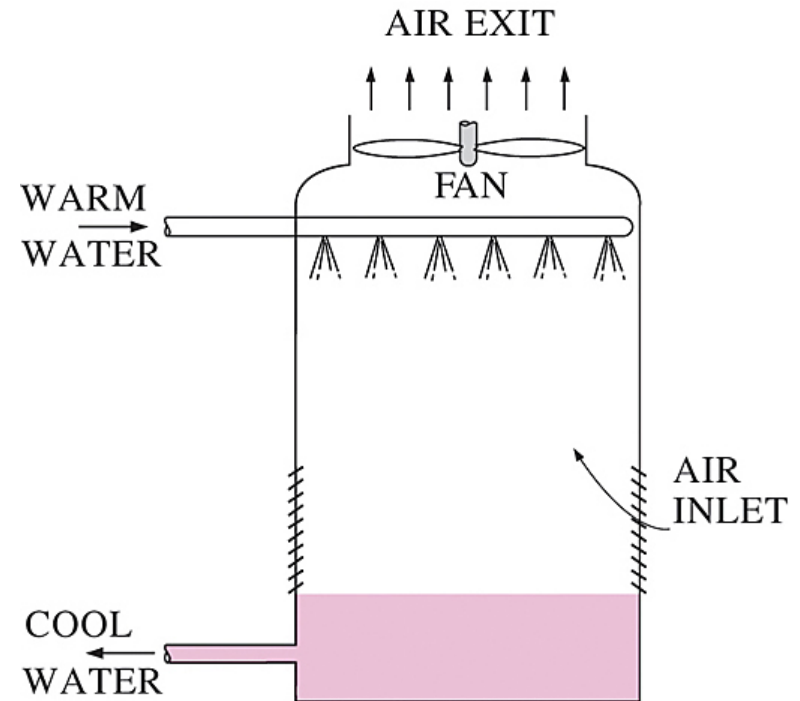

Wet cooling towers - analysis

- Consider CV around tower
- Assume adiabatic, neglect fan work, changes in KE, PE

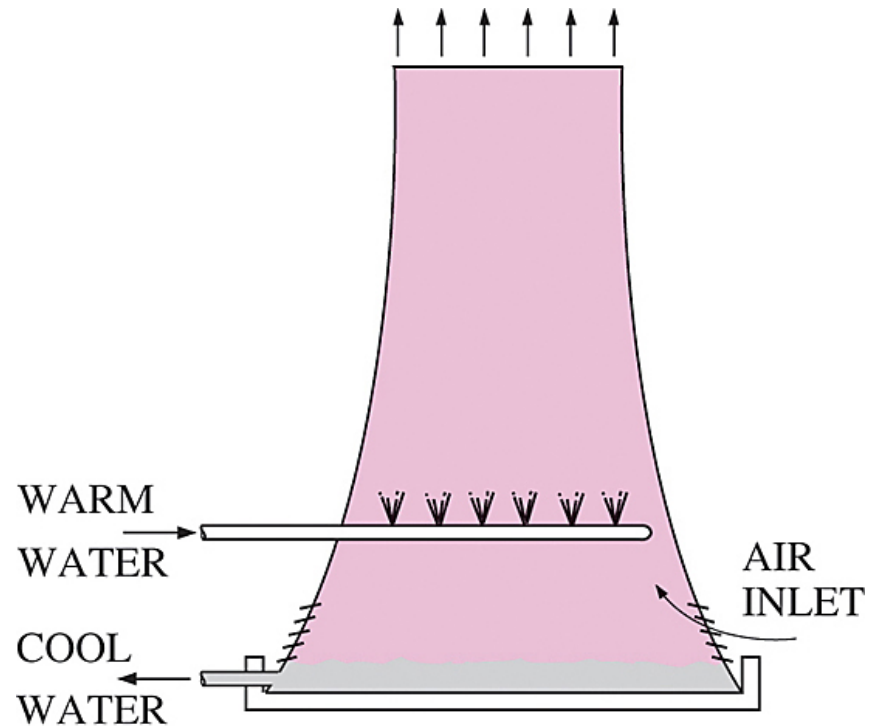

Example 14-9

- Cooling water leaves the condenser of a power plant and enters a wet cooling tower at 35 C at a rate of 100 kg/s. Water is cooled to 22 C in the cooling tower by air that enters the tower at 1 atm, 20 C, and 60% relative humidity and leaves saturated at 30 C. Neglecting the power input to the fan, determine (a) volume flow rate of air into cooling tower and (b) mass flow rate of required makeup water.

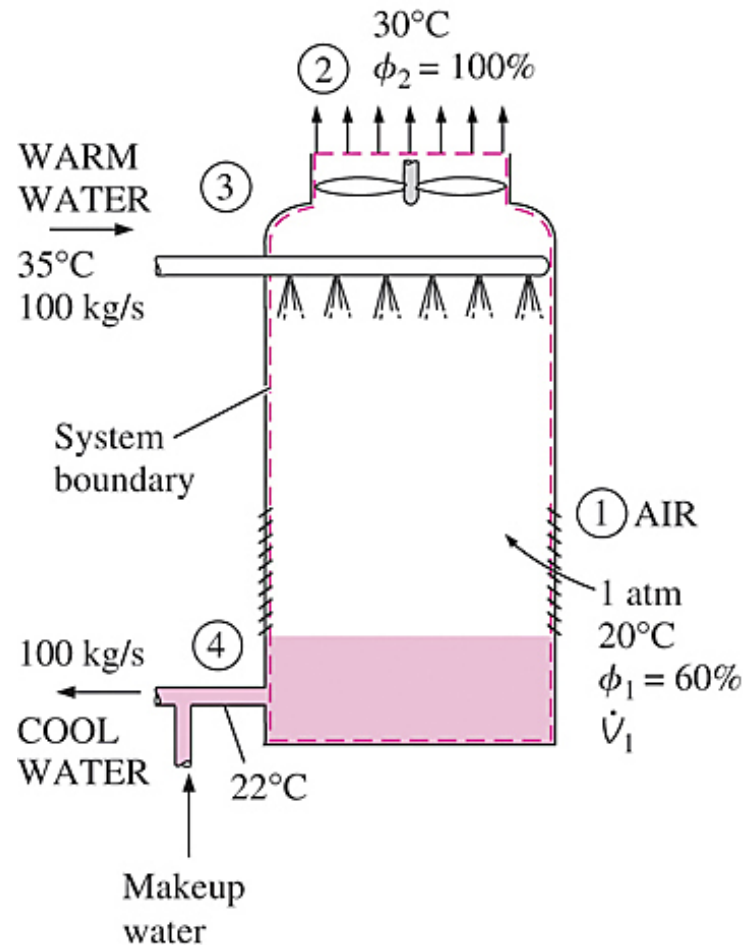

Example 14-9

Example 14-9

Example 14-9

Summary

- In locations with limited cooling water supply, large amounts of waste heat can be rejected to the atmosphere with minimum water loss through the use of cooling towers



Today's Outline

- Refrigeration cycles

Refrigeration cycles

- Refrigerator transfers heat from low-T to high-T
- Cyclic-device
- Working fluid called refrigerant
- Heat pump – different objective
- COP

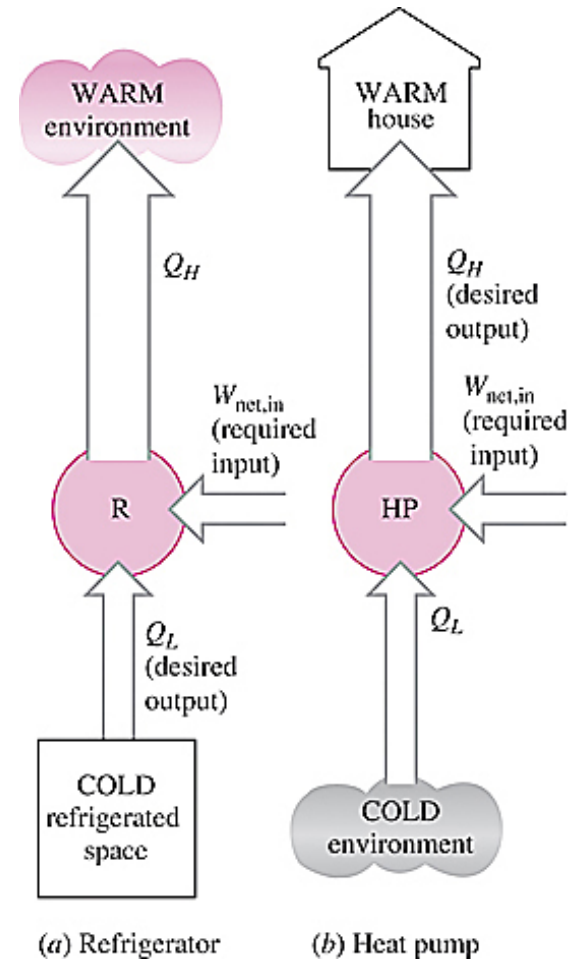

Reversed Carnot cycle

- Carnot cycle – 4 totally reversible processes (2 isothermal and 2 adiabatic)
- Max. efficiency between T limits
- Reverse it to produce Carnot refrigerator or heat pump
- COP
- Practical difficulties

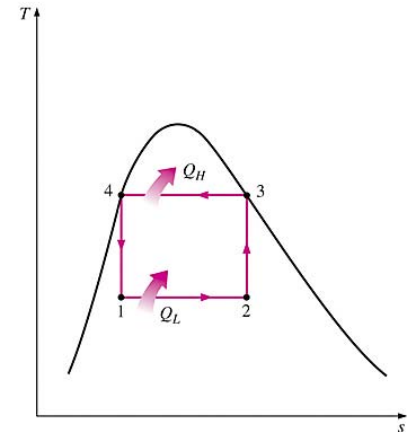
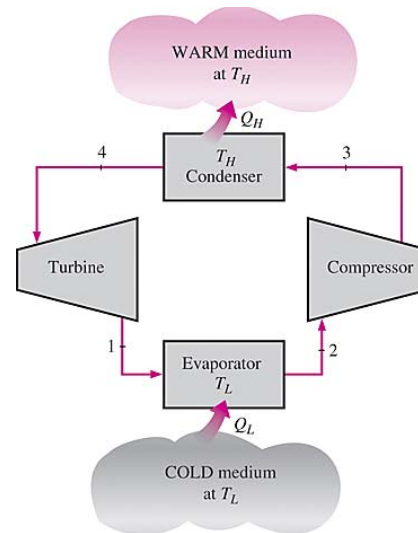

Ideal Vapor Compression Refrigeration (VCR) cycle

- Vaporize completely before compression
- Replace turbine with throttling device
- 4 processes – not internally reversible
 1. Isentropic compression
 2. Constant-P heat rejection
 3. Throttling in expansion device
 4. Constant-P heat absorption
- COP

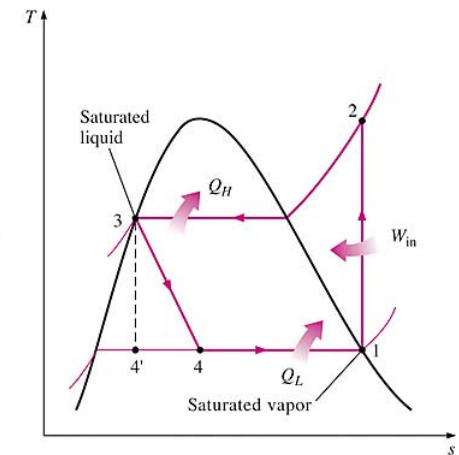
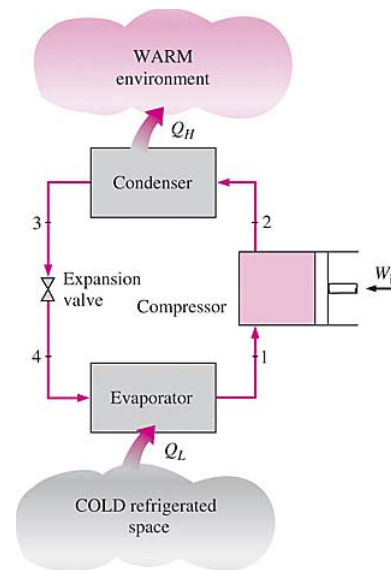

Example 11-1

- A refrigerator uses refrigerant R-134a as working fluid and operates on an ideal VCR cycle between 0.14 and 0.8 MPa. If mass flow rate of refrigerant is 0.05 kg/s, determine (a) rate of heat removal from refrigerated space, (b) rate of heat rejection to environment, and (c) COP of refrigerator

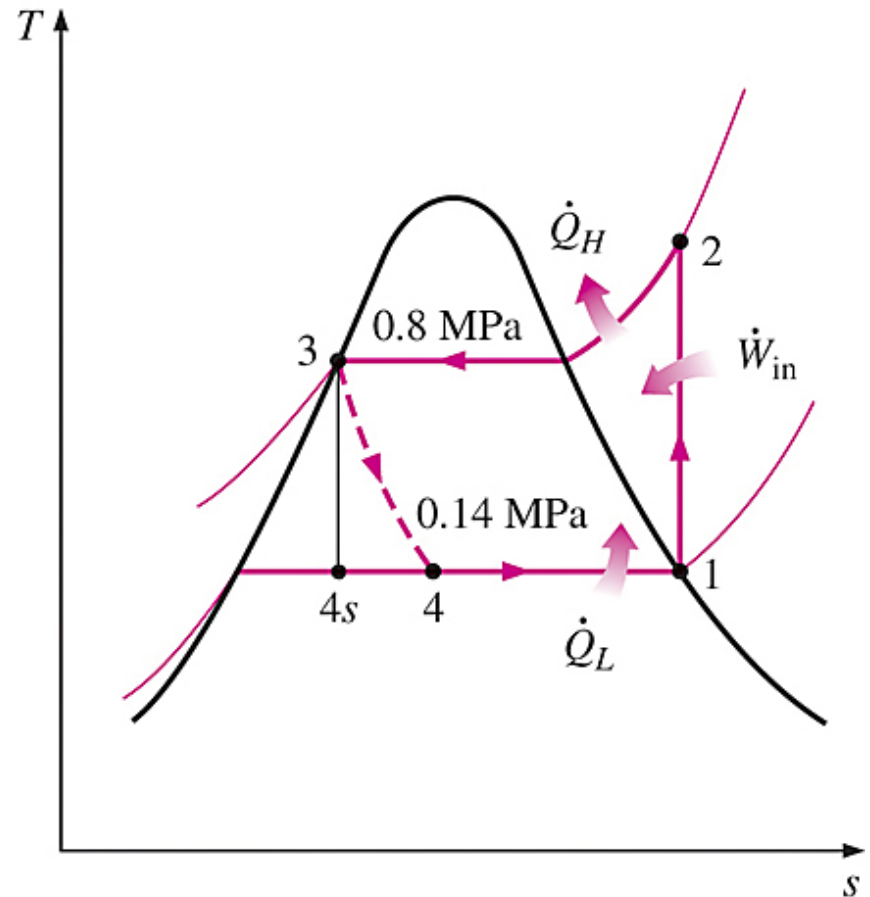

Example 11-1

Example 11-1

Example 11-1

Actual VCR cycle

- Irreversibilities due to:
 - Fluid friction causing pressure drops
 - Heat transfer to/from surroundings

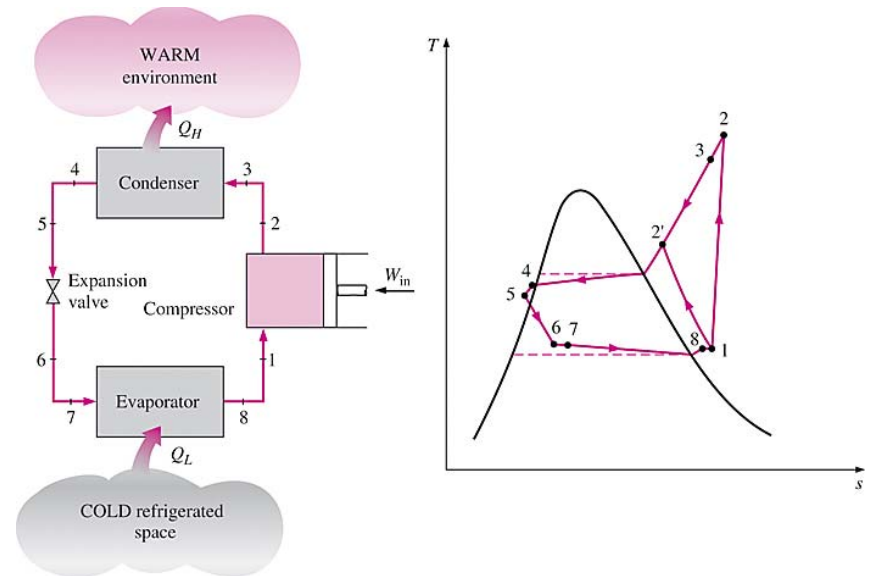

Innovative VCR Systems – Improving Efficiency

- Cascade systems
 - Two or more cycles operating in series
 - Temperature (pressure) range too large for single VCR cycle e.g. compressor
 - Can use same or different refrigerants
 - Mass flow rate ratio
 - COP

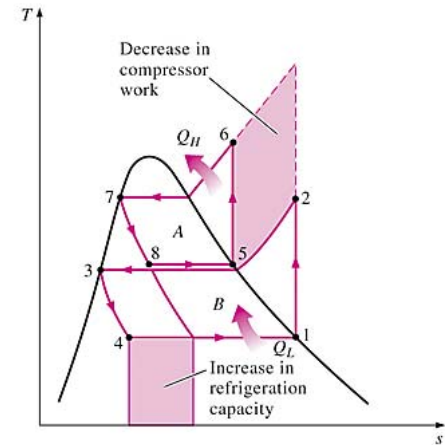
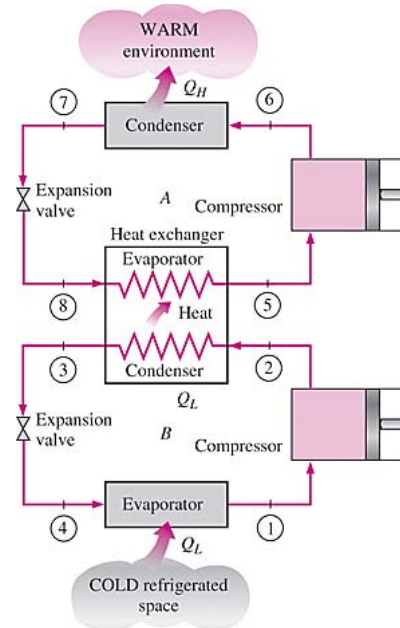

Example 11-3

- Consider a two-stage cascade system between 0.8 and 0.14 MPa. Each stage operates on ideal VCR cycle with R-134a. Heat rejection from lower to upper cycle takes place in adiabatic counterflow HE where both streams enter at ~ 0.32 MPa. Mass flow rate of upper cycle is 0.05 kg/s. Determine (a) mass flow rate of lower cycle, (b) rate of heat removal from refrigerated space, and (c) COP

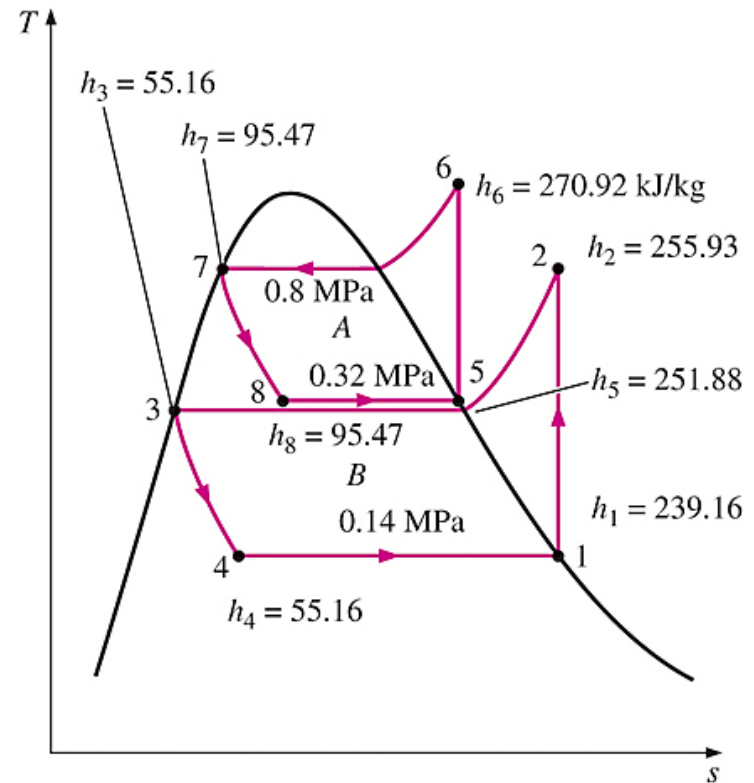

Example 11-3

Example 11-3

Example 11-3

Multistage Compression Refrigeration Systems

- For cascade system with single working fluid, HE can be replaced by mixing chamber (better heat transfer) e.g. flash chamber
- Two-stage compression with intercooling so compressor work decreases
- Note: Mass flow rates are different in different parts of cycle

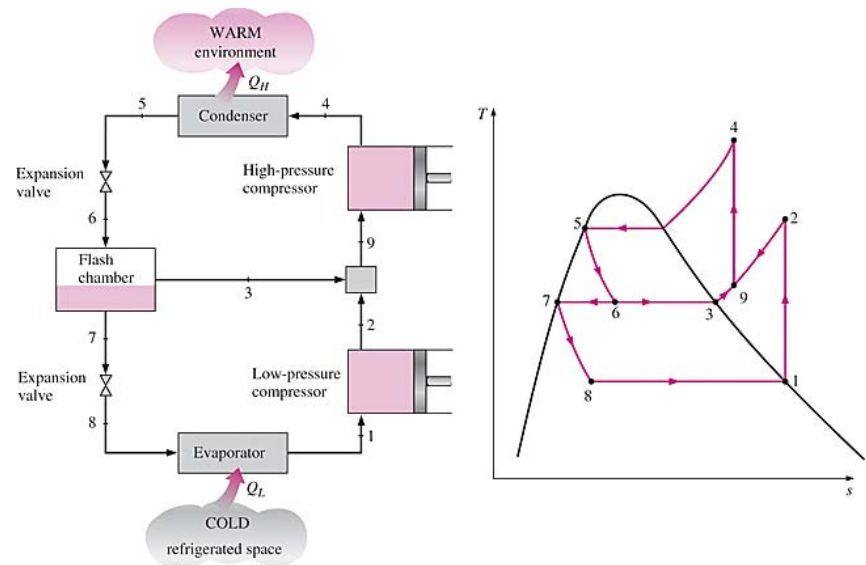

Summary

- Refrigerators transfer heat from lower temperature region to higher one
- Performance measured by COP
- VCR is most widely used cycle
- Very low temperatures achievable by cascading
- Multistage compression is option for single refrigerant